

TECHNIKA ZAMOCOWAŃ





























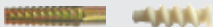





FASTENERS & FIXING SYSTEMS



2023/2024



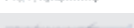
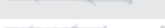

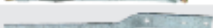









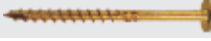

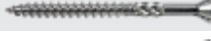













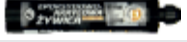









| | | | | |
|----------|---|--|---|-----------|
| 1 | MOCOWANIA TRADYCYJNE I UNIWERSALNE UNIVERSAL FIXINGS | 6-8 | | |
| | Koszulka kołka rozporowego | Plug for solid materials | K...  | 6 |
| | Kołek rozporowy z wkrętem | Plug with a cross-headed wood screw | ...+...  | 6 |
| | Kołek rozporowy z hakiem kątowym | Plug with hook | ..K  | 6 |
| | Kołek rozporowy z hakiem sufitowym | Plug with ceiling hook | ..S  | 6 |
| | Kołek rozporowy z hakiem huśtawkowym | Plug with swing hook | 12/H  | 7 |
| | Kołek rozporowy z wkrętem z łbem sześciokątnym | Plug with a pan cap wood screw | .../...  | 7 |
| | Komplet do mocowania umywalk / WC | Set for fixing washbasins / toilet bowl | KPU/KPM  | 7 |
| | Mocowanie do schodów na podłożu z betonu | Plug for fixing stair treads | TBB  | 7 |
| | Koszulka kołka uniwersalnego | Universal plug | KS  | 7 |
| | Kołek uniwersalny z wkrętem | Universal plug with screw | KS  | 8 |
| | Kołek uniwersalny z hakiem kątowym | Universal plug with hook | KS..K  | 8 |
| | Kołek uniwersalny z hakiem sufitowym | Universal plug with ceiling hook | KS..S  | 8 |
| 2 | MOCOWANIA W TECHNOLOGII SUCHEJ ZABUDOWY FASTENERS IN DRYWALL TECHNOLOGY | 8-11 | | |
| | Kołek stalowy typ "MOLLY" | Hollow wall anchor | SM  | 8 |
| | Kołek do zamocowań w ścianach z G-K „DRIVA” | Driva pin for plaster walls | DRIVA  | 9 |
| | Końcówka do wkrętarki typ "DRIVA" | Screwdriver bit for spit driva | DRIVA-KW  | 9 |
| | Kołek rozporowy do pustych przestrzeni | Toggle anchor for empty spaces | 08G / 10G  | 9 |
| | Kotwa sprężynowa do pustych przestrzeni | Toggle anchor | SP / SP-...O / SP-...Z  | 9 |
| | Samowierzący wkręt do skręcania profili | Self drilling screws | WS39...  | 9 |
| | Samowierzący wkręt do mocowania G-K | Drywall screws | Ws35...  | 10 |
| | Wkręt fosfatowany do blachy / drewna | Drywall screws | FS / FT  | 10 |
| | Kołek rozporowy do gazobetonu | Universal plug for aerated concrete | KRG / KGB  | 10 |
| | Kotwa wbijana metalowa do płyt GK | Hammer-in fixing for plasterboard | KG  | 11 |
| | Wkręt fosfatowany z gwintem do drewna na taśmie | Collated phosphate screw for wood | FTT  | 11 |
| | Wkręt fosfatowany z gwintem do blachy na taśmie | Collated phosphate screw for sheet metal | FTS  | 11 |
| | Wkręt fosfatowany do łączenia płyt G-K | Phosphate screw for drywalls | FTG  | 11 |
| | Wkręt fosfatowany HiLo | Phosphate screw HiLo | HILO  | 11 |
| 3 | KOŁKI SZYBKIEGO MONTAŻU HAMMER DRIVE PLUGS | 12 | | |
| | Kołek do wbijania z lejkiem | Hammer drive plug with nail | ..L...  | 12 |
| | Kołek do wbijania z kołnierzem | Hammer drive plug with nail t-type | ..K...  | 12 |
| | Metalowy kołek do wbijania | Zinc alloy nail in anchor | KMW  | 12 |
| | Kotwa rozprężna do montażu sufitów podwieszanych | Hammer drive in anchor for suspended | GS  | 12 |
| 4 | MOCOWANIA RAMOWE PLUGS FOR SOLID MATERIALS | 13-15 | | |
| | Kołek z długą płaszczyzną podziału z wkrętem | Frame fixing with countersunk head screw | PX  | 13 |
| | Kołek z długą płaszczyzną podziału z wkrętem do drewna | Frame fixing with hexagonal head screw | PK  | 13 |
| | Kołek z długą płaszczyzną podziału z hakiem sufitowym | Frame fixing with ceiling hook | PKS  | 14 |
| | Kołek z długą płaszczyzną podziału z hakiem prostym | Frame fixing with hook | PKH  | 14 |
| | Koszulka kołka z długą płaszczyzną podziału | Frame plug | KRK  | 14 |
| | Kołek z długą płaszczyzną podziału | Frame fixing with screw | KR, KR D  | 15 |
| 5 | MOCOWANIA OŚCIEŻNIC FIXING TO DOOR FRAMES | 16 | | |
| | Wkręt hartowany do mocowania ościeżnic | Concrete screws | WHO/WHOW  | 16 |
| | Kotwa stalowa do ościeżnic | Metal frame anchor | O.., O..K  | 16 |
| | Kotwa metalowa do stolarki okiennej i drzwiowej | Mounting anchor for windows | KM  | 16 |







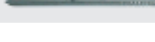





Spis treści







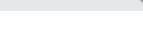

Table of Contents







| | | | | |
|-----------|---|---|--|--------------|
| 6 | WKRETY DO KONSTRUKCJI DREWNIANYCH SCREWS FOR WOODEN CONSTRUCTIONS | | | 17-22 |
| | Wkręt hartowany do drewna, płyt wiórowych i PCV | Chipboard screws countersunk flat | UC / UCK  | 17-18 |
| | Wkręt tarasowy | Terrace screws | FTP  | 18 |
| | Wkręt z łbem talerzowym do drewna i płyt wiórowych | Construction flange head screw | UCSP  | 19 |
| | Wkręt z łbem stożkowym do drewna | Construction flat head screw | UCT / UCTK  | 20-21 |
| | Wkręt tarasowy A2 | Terrace screw A2 | WKRT  | 21 |
| | Wkręt dystansowy | Distance screw | WKRD  | 21 |
| | Wkręt do podkładów | Coach screw | WDP  | 22 |
| 7 | MOCOWANIA ŚREDNICH I DUŻYCH OBIĄŻEŃ HEAVY DUTY FIXINGS | | | 23-26 |
| | Łącznik pierścieniowy | Wedge anchor | ŁP  | 23 |
| | Kotwa opaskowa z oczkiem sufitowym | Ceiling anchor with eye yellow zinc | SRS  | 23 |
| | Kotwa śrubowa do betonu Anchor Bolt | Anchor Bolt | FCB  | 24 |
| | Kotwa rozprężna | Sleeve anchors (yellow zinc) | KT  | 24 |
| | Kotwa rozprężna z hakiem sufitowym | Sleeve anchors with ceiling hook | KTS  | 24 |
| | Stalowy łącznik jedno i dwurozporowy SŁR | Steel anchor bolt | J, D  | 24-25 |
| | Tuleja mosiężna | Brass anchors | TM  | 26 |
| | Tuleja stalowa | Drop in anchors | TS  | 26 |
| | Osadzak do tulei stalowych | Setting tool for steel drop | OTS  | 26 |
| | Wiertło do tulei stalowych | Drilling tool for steel drop | N-SDS  | 26 |
| | Zacisk TKL | Beam clamp | TKL  | 26 |
| 8 | SYSTEM KOTEW CHEMICZNYCH CHEMICAL ANCHORS | | | 27-28 |
| | Żywica chemiczna poliestrowa | Chemical Anchors Polyester | KCH  | 27 |
| | Żywica chemiczna epoksydowo-akrylowa | Chemical Anchors Epoxy-acrylate | KCH  | 27 |
| | Żywica winylestrowa | Chemical Anchors Vinyl-ester | KCH  | 27 |
| | Pręt gwintowany z zakończeniem heksagonalnym | Chemical Anchor Threaded Rod | KCH  | 27 |
| | Tuleja siatkowa | Plastic sleeve | KCH  | 27 |
| | Akcesoria (mikser, pompka do wydmuchiwania zwiercin) | Accessories (mixing nozzle, blow out pump) | KCH  | 28 |
| | Szczotka do czyszczenia otworów | Hole cleaning brush | KCH  | 28 |
| 9 | MOCOWANIA IZOLACJI TERMICZNYCH - FASADY I DACHY THERMAL INSULATION FIXING | | | 29-31 |
| | Łącznik do izolacji z krótką strefą rozporową | Connector for insulation | ŁIN, ŁIMO  | 29 |
| | Łącznik do izolacji z przedłużoną strefą rozporową | Connector for insulation | ŁIPN, ŁIPMO  | 29 |
| | Frez tworzywowy | Cutter for holes | STYR  | 30 |
| | Zaślepka styropianowa/wełniana | Styrofoam/mineral wool plug | STYR  | 30 |
| | Kołnierz bez wkręta | Pressure flange with a plug | ŁIK  | 30 |
| | Talerzyk dociskowy do mocowania wełny | Pressure plate for fastening wool | KWL  | 30 |
| | Dybel do mocowania w fasadzie | Pin for fastening | PFI  | 30 |
| | Hak do rusztowań | Zinc Plating Eye Screw | HRR1/HRR5  | 31 |
| 10 | GWOŹDZIE STEEL NAILS | | | 32-34 |
| | Gwoździe utwardzane | Hardened steel nails | GU  | 32 |
| | Gwoździe utwardzane walcowane | Hardened steel nail grooved shank | GUW  | 32 |
| | Gwoździe utwardzane walcowane z podkładką | Hardened steel nail grooved shank with washer | GUP  | 32 |
| | Gwoździe stolarskie ocynkowane i miedziane | Finishing nail | GSO, GSM  | 32 |
| | Gwoździe budowlane czarne | Common nails | GWBU  | 33 |





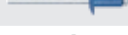

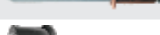



| | | | | |
|-----------------------------------|----------------------|------------------|---|----|
| Gwoździe „ANCHOR” | Steel nails "Anchor" | GKA |  | 33 |
| Gwoździe papowe z podkładką | Roofing nails | GWPAP |  | 33 |
| Gwoździe papowe | Roofing nails | GWPA / GWPA...CZ |  | 33 |
| Gwoździe skręcane | Square twisted nails | GWS |  | 34 |
| Gwoździe SKOBLE do montażu siatki | U-nails | SKO |  | 34 |

| | | | | |
|--|--|------------|---|--------------|
| 11 | WKRETY SAMOWIERCĄCE SELF DRILLING SCREWS | | | 35-39 |
| Wkręt samowiertny do mocowania blach | Self drilling screw, hex washer head | OC |  | 35 |
| Wkręt do mocowania okuć z łbem stożkowym | Pan head screw with square recess | WMW |  | 35 |
| Wkręt samowiertny z podkładką EPDM | Self-drilling roofing screw with EPDM washer | OCG |  | 36 |
| Wkręt samowiertny do płyt warstwowych | Self drilling screw with EPDM washer | OWG / OWB |  | 36-37 |
| Podkładka EPDM | EPDM washer | EPDM |  | 37 |
| Wkręt samowiertny do stolarki PCV | Windows buliding self-drilling screws | KS-39... |  | 37 |
| Blachowkręt samowiertny z gniazdem kwadratowym | Windows buliding self-taping screws | KSO |  | 37 |
| Wkręt montażowy uniwersalny | Wafer head phillips (sharp point) | WM / WMF |  | 38 |
| Wkręt montażowy samowiertny | Wafer head phillips (self-drilling) | WMS / WMSF |  | 38 |
| Blachowkręt samowiertny z łbem walcowym | Pan head sheet metal screw | OCS |  | 39 |
| Wkręt do cienkich blach, ze skrzydełkami | Self drilling screws with wings | KSS |  | 39 |

| | | | | |
|--------------------------------------|--|----------|---|--------------|
| 12 | SYSTEM MOCOWAŃ DACHOWYCH ROOF FIXING | | | 40-42 |
| Tuleja do mocowania pokryć dachowych | Telescopic sleeve with round plate | GOK |  | 40 |
| Wkręt do blach | Self-drilling screw for steel assembly | EDSB |  | 40 |
| Wkręt do blach | Self-drilling screw for steel assembly | EDSS |  | 41 |
| Łącznik izolacyjny do betonu | Insulation screws for concrete construction | GTHB |  | 41 |
| Łącznik do dachów betonowych | Plug for concrete roofs | KKW |  | 41 |
| Wkręt farmerski | Self-drilling farmer screw with EPDM washer | OD / ODI |  | 41-42 |
| Wkręt farmerski ETANCO typu PAN HEAD | Panhead farmer screw | FTX |  | 42 |
| Kołnierz uszczelniający | Sealing collar | MF |  | 42 |
| Farba zaprawkowa | Spray primers | FA |  | 42 |

| | | | | |
|--|---|--------|---|--------------|
| 13 | NITY RIVETS | | | 43-44 |
| Nit zrywalny Al/Fe | Open type blind rivet with dome head, Al/Fe | NIT |  | 43 |
| Nit zrywalny ze stali nierdzewnej A2 (INOX/INOX) | Open type blind rivet with dome head, A2 | NITN |  | 43 |
| Nit zrywalny Al/Fe lakierowany | Open type blind rivet with dome head, Al/Fe | NITL |  | 43 |
| Nit zrywalny Fe/Fe | Open type blind rivet with dome head, Fe/Fe | NITS |  | 44 |
| Nit zrywalny Cu/Fe | Open type blind rivet with dome head, Cu/Fe | NITMS |  | 44 |
| Nitonakrętka stalowa | Rivets nuts | NITONA |  | 44 |

| | | | | |
|----------------------------|---|----------|---|--------------|
| 14 | LINY I AKCESORIA DO LIN ROPES AND ACCESSORIES FOR ROPES | | | 45-46 |
| Lina stalowa | Steel wire ropes, galvanized | LSZ |  | 45 |
| Lina stalowa w powłoce PCV | Steel wire ropes, galvanized, PVC coated | LPS |  | 45 |
| Lina stalowa nierdzewna A4 | A4 stainless steel wire rope | INOX-LSZ |  | 46 |
| Lina stalowa z pętelkami | Steel wire rope with loops | LSZP |  | 46 |
| Lina pleciona | Braided (polypropylene) twine | LP |  | 46 |
| Lina elastyczna | Braided flexible twine | LPG |  | 46 |
| Sznurek murarski | Mason twine | SZM |  | 46 |
| Lina jutowa | Jute twine | LJ |  | 46 |



Spis treści

Table of Contents

| | | | | |
|--|---|-----------------------------|--|--------------|
| 15 | AKCESORIA DO LIN ACCESSORIES FOR ROPES | | | 47-56 |
| Bloczek budowlany | Pulley | BLOB, BLO | | 47 |
| Kausza | Wire rope thimble | KA | | 47 |
| Zacisk siodełkowy pojedynczy i podwójny | Single/ double clamp | ZACS / ZACSP | | 48 |
| Zacisk linowy - kubekowy | Egg shaped wire rope clip | ZACK | | 48 |
| Zacisk do lin | Wire rope clip | ZAC | | 48 |
| Szeka | European type Dee shackle | SZE / SZED / SZEO | | 49 |
| Śruba rzymska korpus | Turnbuckle | ŚRZK | | 49 |
| Śruba rzymska hak - ucho | Turnbuckle hook-eye | ŚRZ | | 50 |
| Śruba rzymska | Turnbuckle | ŚRZH / ŚRZU / ŚRZP | | 50 |
| Śruba rzymska DIN1480 | Turnbuckle | ŚRZD / ŚRZDHH / ŚRZDUU | | 51 |
| Hak huśtawkowy z karabińczykiem lub szekłą | Swing hooks | HHK / HHS | | 52 |
| Hak zwykły z zabezpieczeniem | Hook | HAK, ...U, ...Z, ...S, ...O | | 52-53 |
| Ogniwo typ „S” | Quick link type S | OGN | | 53 |
| Ogniwo zaklepywane | Repair link | OGZ | | 53 |
| Ogniwo skręcane | Quick link | OGS | | 53 |
| Kółko zgrzewane | Steel welded ring | KZ | | 53 |
| Śruba z uchem | Eye screw | ŚRU | | 54 |
| Nakrętka z uchem | Eye nut | NAKU | | 54 |
| Karabińczyk ozdobny | Snap hook | KAR | | 54 |
| Karabińczyk do lin | Snap hook | KAR, KARZ | | 54 |
| Naciąg do siatki, śruba naciągowa | Wire stretcher | NAC | | 55 |
| Zawlecza rolnicza | Spring pin | ZAW, ZAB | | 55 |
| Zawlecza rozginana | Linch pin | ZAR | | 55 |
| Spinacz do łańcuchów | Swivel snap hook | SP, SPO | | 56 |
| Krętlik dwustronny niklowany | Swivel nickel plated | KREN | | 56 |
| Okrętka super | Swivel link | OKR | | 56 |
| Tuleja aluminiowa typ A | Aluminum sleeve | T-TA | | 56 |
| 16 | ŁAŃCUCHY CHAINS | | | 57-58 |
| Łańcuch techniczny | Technical steel chain | ŁA | | 57 |
| Łańcuch gospodarczy „D-1” | Steel chain type D1 | ŁAG | | 57 |
| Łańcuch gospodarczy „D-2” | Steel chain type D2 | ŁAGD | | 57 |
| Łańcuch gospodarczy „D-1”, ocynk ogniowy | Hot Dip Galvanized Chain | ŁAGO | | 57 |
| Łańcuch plastikowy | Plastick Chain | ŁAPL | | 58 |
| Łańcuch węzłowy „Viktor” | VICTOR nodal chain | ŁAV | | 58 |
| Łańcuszek niezgrzewany ocynkowany | Zinc-plated steel chain | ŁAN | | 58 |
| Łańcuch spinający | Spanning chain | ŁASP | | 58 |
| Łańcuch gospodarczy (pastwiskowy, żłobowy) | Grazing steel chain / Black manger chain | ŁAPA, ŁAŻ | | 58 |
| 17 | ELEKTRODY SPAWALNICZE WELDING ELECTRODES | | | 59-60 |
| Elektroda RC, zasadowa PLASMA, INOX | Welding electrode | EL | | 59 |
| Drut spawalniczy | Welding wire | DRS, DR | | 59-60 |
| Elektroda ER 146 i 150 | Welding electrode | ELER, ELEB | | 60 |
| Elektroda OVERCORD E | Welding electrode | ELO | | 60 |
| Elektroda i RUTILEN-12 | Welding electrode | ELR, ELRP | | 60 |
| Elektroda INOX 308L | Welding electrode | EL...-INOX | | 60 |
| 18 | SYSTEMY INSTALACYJNE INSTALLATION SYSTEMS | | | 61-63 |
| Hak grzejnikowy - kątowny | Galvanized bent radiator hook | HGK, HGKM | | 61 |



| | | | | | |
|-----------|---|------------------------------------|-------------------------|--|--------------|
| | Hak grzejnikowy - prosty | Galvanized radiator hook with long | HG, HGM | | 61 |
| | Uchwyt metalowy do rur | Pipe clamp | UP, U | | 61 |
| | Uchwyt metalowy do rur z uszczelką | Pipe clamp with gasket | UPT, UT | | 61 |
| | Taśma SERRATUB W2 9mm | Hose Clamp Roll | TAŚ, ZAMEK | | 61 |
| | Opaska ślimakowa K-2 | GM (GERMAN MIDDLE) type hose clamp | OBI, OBN | | 62 |
| | Opaska GBS | GBS pipe clamp | OBB | | 62 |
| | Cybant, łącznik do cybantów | U-bolt, connector | CYBB, CYBŁ, CYBK | | 63 |
| | Taśma montażowa | Perforated tape | TBANW | | 63 |
| 19 | ZŁĄCZA CIESIELSKIE SIMPSON STRONG-TIE ETANCO CONNECTORS FOR TIMBER | | | | 64-68 |
| 20 | METALOWE SYSTEMY NOŚNE BAKS METAL SUPPORTING SYSTEMS | | | | 69-70 |
| 21 | ŁĄCZNIKI GWINTOWANE THREADED CONNECTOR | | | | 71-76 |
| | Wkręt dwugwintowy | Hanger bolt | Ś5 | | 71 |
| | Wkręt do drewna z łbem sześciokątnym | Coach screw | ŚZA | | 72-73 |
| | Śruba z łbem sześciokątnym z gwintem | Hexagonal head bolt fully threaded | WDT | | 73 |
| | Pręt gwintowany | Threaded rod | PRIA / PRI | | 73-74 |
| | Łącznik śrubowy TYP L | T-rod L-type | KML, KMLO | | 75 |
| | Hak huśtawkowy | Hook pigtail | HHH | | 75 |
| | Hak oczkowy zamknięty | Hook o-type | HHZ | | 76 |
| | Hak oczkowy otwarty | Hook c-type | HHO | | 76 |
| | Hak prosty | Hook square | HHP | | 76 |
| | Śruba lemieszowa / płużna | Plow Bolt | ŚL | | 76 |
| 22 | PODKŁADKI WASHERS | | | | 77-78 |
| | Podkładka okrągła zgrubna | Round washer | POD | | 77 |
| | Podkładka okrągła poszerzona | Enlarged round washer | POP30 | | 77 |
| | Podkładka okrągła poszerzona | Enlarged round washer | POP19 | | 77 |
| | Podkładka sprężysta | Spring washer | PODS | | 78 |
| | Podkładka do konstrukcji drewnianych | Wood construction washers | POK | | 78 |
| | Podkładka do gwoździ papowych | Washer for nails | PODPAP | | 78 |
| 23 | NAKRĘTKI NUTS | | | | 78-79 |
| | Nakrętka złączna | Coupling nuts | NZ | | 78 |
| | Nakrętka pazurkowa | T-nut | NAKP | | 79 |
| | Nakrętka sześciokątna | Metric hexagon nut | NAK, NAKC | | 79 |
| | Nakrętka samokontrująca z wkładką poliamidową | Plain nylon insert lock nut | NAKWK | | 79 |
| | Nakrętka kołpakowa | Hexagonal domed cap nut | NAKK | | 79 |
| | Nakrętka kołnierзова | Hexagonal flange nut | NAKZ | | 79 |
| | Nakrętka motylkowa | Wing nut | NAM | | 79 |
| 24 | KONFIRMATY I AKCESORIA DO KONFIRMATÓW CONFIRMATES AND ACCESSORIES FOR CONFIRMATIONS | | | | 80 |
| | Konfirmat | Furniture screws | KONF | | 80 |
| | Wiertło do konfirmatów | Confirmat drill | WRKON | | 80 |
| | Klucz do konfirmatów | Key to furniture screw | KONFKL | | 80 |
| 25 | BLISTRY - opakowania detaliczne BLISTER PACKAGE | | | | 81-91 |
| 26 | ARTYKUŁY FIRMY FISCHER FISHER PRODUCTS | | | | 92-95 |
| 27 | ELEMENTY TWORZYWOWE PLASTIC ELEMENTS | | | | 96 |

Koszulka kotka rozporowego

Plug for solid materials



| INDEX | ROZMIAR SIZE [mm] | ILOŚĆ [szt.] QUANTITY [pcs] | | CENA / PRICE 1000 szt./pcs [PLN] |
|---------|----------------------|--------------------------------|------|--|
| | | | | |
| K-05 | 5 x 25 | 500 | 6000 | 24,23 |
| K-06 | 6 x 30 | 500 | 6000 | 32,11 |
| K-08 | 8 x 40 | 250 | 3000 | 47,16 |
| K-10 | 10 x 50 | 200 | 2400 | 74,69 |
| K-12 | 12 x 60 | 100 | 1200 | 132,59 |
| K-12/80 | 12 x 80 | 50 | 600 | 203,64 |
| K-14 | 14 x 80 | 50 | 600 | 235,24 |
| K-16 | 16 x 80 | 50 | 600 | 460,98 |
| K-20 | 20 x 95 | 25 | 300 | 782,10 |

Kotek rozporowy z wkrętem z łbem stożkowym z nacięciem krzyżowym typ POZIDRIVE

Plug with a cross-headed wood screw type POZIDRIVE



| INDEX | ROZMIAR SIZE [mm] | | ILOŚĆ [szt.] QUANTITY [pcs] | | CENA / PRICE 1000 szt./pcs [PLN] |
|--------|----------------------|-----------|--------------------------------|------|--|
| | | | | | |
| 05+ | 5 x 25 | 3,5 x 30 | 200 | 4800 | 71,51 |
| 06+ | 6 x 30 | 3,5 x 30 | 200 | 4800 | 81,23 |
| 06+340 | 6 x 30 | 3,5 x 40 | 200 | 4800 | 102,82 |
| 06+350 | 6 x 30 | 3,5 x 50 | 200 | 4800 | 125,78 |
| 06+440 | 6 x 30 | 4,0 x 40 | 200 | 4800 | 120,98 |
| 06+450 | 6 x 30 | 4,0 x 50 | 200 | 4800 | 135,91 |
| 08+ | 8 x 40 | 4,0 x 45 | 200 | 2400 | 133,16 |
| 08+450 | 8 x 40 | 4,0 x 50 | 200 | 2400 | 147,91 |
| 08+460 | 8 x 40 | 4,0 x 60 | 200 | 2400 | 165,94 |
| 08+550 | 8 x 40 | 5,0 x 50 | 200 | 2400 | 197,54 |
| 08+560 | 8 x 40 | 5,0 x 60 | 200 | 2400 | 233,38 |
| 08+580 | 8 x 40 | 5,0 x 80 | 200 | 2400 | 296,75 |
| 08+100 | 8 x 40 | 5,0 x 100 | 200 | 2400 | 330,80 |
| 10+560 | 10 x 50 | 5,0 x 60 | 100 | 1200 | 272,77 |
| 10+580 | 10 x 50 | 5,0 x 80 | 100 | 1200 | 324,75 |
| 10+660 | 10 x 50 | 6,0 x 60 | 100 | 1200 | 362,38 |
| 10+680 | 10 x 50 | 6,0 x 80 | 100 | 1200 | 426,91 |
| 10+100 | 10 x 50 | 6,0 x 100 | 100 | 1200 | 516,52 |

Kotek rozporowy z hakiem

Plug with hook



| INDEX | ROZMIAR SIZE [mm] | | ILOŚĆ [szt.] QUANTITY [pcs] | | CENA / PRICE 1000 szt./pcs [PLN] |
|-------|----------------------|------|--------------------------------|------|--|
| | | | | | |
| 06K | 6 x 30 | 4,0 | 200 | 4800 | 162,00 |
| 08K | 8 x 40 | 5,0 | 200 | 2400 | 283,63 |
| 10K | 10 x 50 | 6,0 | 100 | 1200 | 467,20 |
| 12K | 12 x 60 | 8,0 | 50 | 600 | 1029,66 |
| 14K | 14 x 80 | 10,0 | 25 | 300 | 1916,74 |

Kotek rozporowy z hakiem sufitowym i huśtawkowym

Plug with ceiling hook / swing hook



S



H



| INDEX | ROZMIAR SIZE [mm] | | ILOŚĆ [szt.] QUANTITY [pcs] | | CENA / PRICE 1000 szt./pcs [PLN] |
|-------|----------------------|-----|--------------------------------|------|--|
| | | | | | |
| 06S | 6 x 30 | 4,0 | 200 | 4800 | 232,31 |
| 08S | 8 x 40 | 5,0 | 100 | 1200 | 418,89 |
| 10S | 10 x 50 | 6,0 | 50 | 600 | 678,40 |
| 12S | 12 x 60 | 8,0 | 50 | 600 | 1330,22 |
| 12H | 12 x 60 | 8,0 | 25 | 300 | 2204,31 |

Kołek rozporowy z wkrętem z łbem sześciokątnym

Plug with a pan cap wood screw



| INDEX | ROZMIAR SIZE [mm] | | ILOŚĆ [szt.] QUANTITY [pcs] | | CENA / PRICE 1000 szt./pcs [PLN] |
|--------|----------------------|----------|--------------------------------|------|--|
| | | | | | |
| 08/550 | 8 x 40 | 5 x 50 | 200 | 2400 | 265,65 |
| 08/560 | 8 x 40 | 5 x 60 | 100 | 1200 | 341,55 |
| 08/580 | 8 x 40 | 5 x 80 | 100 | 1200 | 406,08 |
| 10/660 | 10 x 50 | 6 x 60 | 100 | 1200 | 307,31 |
| 10/680 | 10 x 50 | 6 x 80 | 100 | 1200 | 378,08 |
| 10/100 | 10 x 50 | 6 x 100 | 50 | 600 | 473,54 |
| 10/120 | 10 x 50 | 6 x 120 | 50 | 600 | 535,85 |
| 12/060 | 12 x 60 | 8 x 60 | 50 | 600 | 561,86 |
| 12/080 | 12 x 60 | 8 x 80 | 50 | 600 | 708,62 |
| 12/100 | 12 x 80 | 8 x 100 | 25 | 300 | 905,08 |
| 12/120 | 12 x 80 | 8 x 120 | 25 | 300 | 1075,38 |
| 12/140 | 12 x 80 | 8 x 140 | 25 | 300 | 1181,31 |
| 12/160 | 12 x 80 | 8 x 160 | 25 | 300 | 1430,26 |
| 12/180 | 12 x 80 | 8 x 180 | 25 | 300 | 1543,33 |
| 12/200 | 12 x 80 | 8 x 200 | 25 | 300 | 1683,42 |
| 14/080 | 14 x 80 | 10 x 80 | 25 | 300 | 1155,85 |
| 14/100 | 14 x 80 | 10 x 100 | 25 | 300 | 1334,46 |
| 14/120 | 14 x 80 | 10 x 120 | 25 | 300 | 1477,77 |
| 14/140 | 14 x 80 | 10 x 140 | 25 | 300 | 1758,15 |
| 14/160 | 14 x 80 | 10 x 160 | 25 | 300 | 2184,27 |
| 14/180 | 14 x 80 | 10 x 180 | 25 | 300 | 2368,89 |
| 14/200 | 14 x 80 | 10 x 200 | 25 | 300 | 2559,74 |
| 14/220 | 14 x 80 | 10 x 220 | 25 | 300 | 2792,82 |
| 16/100 | 16 x 80 | 10 x 100 | 25 | 300 | 1582,77 |
| 16/120 | 16 x 80 | 10 x 120 | 25 | 300 | 1726,08 |
| 16/140 | 16 x 80 | 10 x 140 | 25 | 300 | 2006,46 |
| 16/160 | 16 x 80 | 10 x 160 | 25 | 300 | 2214,15 |
| 16/180 | 16 x 80 | 10 x 180 | 25 | 300 | 2644,79 |
| 16/200 | 16 x 80 | 10 x 200 | 25 | 250 | 2835,64 |
| 16/220 | 16 x 80 | 10 x 220 | 25 | 250 | 3068,72 |
| 20/120 | 20 x 95 | 12 x 120 | 10 | 120 | 3138,46 |
| 20/180 | 20 x 95 | 12 x 180 | 10 | 120 | 4084,62 |

Komplet do mocowania umywalki - Jeden komplet zawiera 2 sztuki

Set for fixing washbasins - One set contains 2 pieces



| INDEX | ROZMIAR SIZE [mm] | | ILOŚĆ [komplet] QUANTITY [set] | | CENA / PRICE 1 kpl./set [PLN] |
|----------|----------------------|----------|-----------------------------------|----|-------------------------------------|
| | | | | | |
| KPU1-100 | 12 x 60 | 8 x 100 | 1 | 50 | 3,84 |
| KPU1-120 | 12 x 60 | 8 x 120 | 1 | 50 | 3,95 |
| KPU1-140 | 14 x 80 | 10 x 140 | 1 | 50 | 5,25 |

Komplet do mocowania muszli klozetowych - Jeden komplet zawiera 2 sztuki

Set for fixing toilet bowls - One set contains 2 pieces



| INDEX | ROZMIAR SIZE [mm] | | ILOŚĆ [komplet] QUANTITY [set] | | CENA / PRICE 1 kpl./set [PLN] |
|---------|----------------------|--------|-----------------------------------|----|-------------------------------------|
| | | | | | |
| KPM-100 | 10 x 50 | 6 x 80 | 1 | 30 | 1,96 |

Mocowanie do schodów na podłożu z betonu

Plug for fixing stair treads



| INDEX | ŚR. OTWORU W STOPNICY Diameter of the hole in the tread [mm] | ŚR. OTWORU W BETONIE Diameter of the hole in concrete [mm] | ILOŚĆ [szt.] QUANTITY [pcs] | | CENA / PRICE 1 szt./pcs [PLN] |
|-------|--|--|--------------------------------|-----|-------------------------------------|
| | | | | | |
| TBB1 | 14 x 25 | 8 x 55 | 50 | 250 | 2,53 |

Koszulka kotka uniwersalnego - nylon

Universal plug



| INDEX | ROZMIAR SIZE [mm] | ILOŚĆ [szt.] QUANTITY [pcs] | | CENA / PRICE 1000 szt./pcs [PLN] |
|-------|----------------------|--------------------------------|------|--|
| | | | | |
| KS-05 | 5 x 32 | 500 | 6000 | 36,00 |
| KS-06 | 6 x 40 | 500 | 6000 | 50,00 |
| KS-08 | 8 x 50 | 200 | 2400 | 105,00 |
| KS-10 | 10 x 60 | 100 | 1200 | 197,54 |
| KS-12 | 12 x 70 | 100 | 1200 | 235,00 |
| KS-14 | 14 x 76 | 100 | 1200 | 273,00 |

Mocowania tradycyjne i uniwersalne

Universal fixings

Kołek uniwersalny z wkrętem z tłem stożkowym i nacięciem krzyżowym typu POZIDRIVE

Universal plug with a screw type POZIDRIVE



| INDEX | ROZMIAR SIZE [mm] | | ILOŚĆ [szt.] QUANTITY [pcs] | | CENA / PRICE 1000 szt./pcs [PLN] |
|----------|----------------------|----------|--------------------------------|------|--|
| | | | | | |
| KS-05035 | 5 x 32 | 3,5 x 35 | 200 | 2400 | 82,45 |
| KS-05045 | 5 x 32 | 3,5 x 45 | 200 | 2400 | 89,20 |
| KS-06040 | 6 x 40 | 4 x 40 | 200 | 2400 | 137,44 |
| KS-06050 | 6 x 40 | 4 x 50 | 200 | 2400 | 150,38 |
| KS-06060 | 6 x 40 | 4 x 60 | 200 | 2400 | 168,41 |
| KS-08050 | 8 x 50 | 5 x 50 | 100 | 1200 | 249,85 |
| KS-08060 | 8 x 50 | 5 x 60 | 100 | 1200 | 285,69 |
| KS-08070 | 8 x 50 | 5 x 70 | 100 | 1200 | 310,78 |
| KS-10060 | 10 x 60 | 6 x 60 | 50 | 600 | 489,15 |
| KS-10070 | 10 x 60 | 6 x 70 | 50 | 600 | 521,42 |
| KS-10080 | 10 x 60 | 6 x 80 | 50 | 600 | 553,68 |
| KS-10100 | 10 x 60 | 6 x 100 | 50 | 600 | 643,29 |
| KS-12080 | 12 x 70 | 8 x 80 | 50 | 600 | 785,00 |
| KS-12100 | 12 x 70 | 8 x 100 | 50 | 600 | 909,00 |
| KS-12120 | 12 x 70 | 8 x 120 | 50 | 600 | 1121,00 |

Kołek rozporowy uniwersalny z hakiem kątowym

Universal plug with hook



| INDEX | ROZMIAR SIZE [mm] | | ILOŚĆ [szt.] QUANTITY [pcs] | | CENA / PRICE 1000 szt./pcs [PLN] |
|--------|----------------------|-----|--------------------------------|------|--|
| | | | | | |
| KS-06K | 6 x 40 | 3,5 | 200 | 2400 | 438,00 |
| KS-08K | 8 x 50 | 4,5 | 100 | 1200 | 673,00 |

Kołek rozporowy uniwersalny z hakiem sufitowym

Universal plug with ceiling hook



| INDEX | ROZMIAR SIZE [mm] | | ILOŚĆ [szt.] QUANTITY [pcs] | | CENA / PRICE 1000 szt./pcs [PLN] |
|--------|----------------------|-----|--------------------------------|------|--|
| | | | | | |
| KS-06S | 6 x 40 | 3,5 | 200 | 2400 | 510,00 |
| KS-08S | 8 x 50 | 4,5 | 100 | 1200 | 715,69 |

Mocowania w technologii suchej zabudowy

Fasteners in drywall technology

Kołek stalowy typ "MOLLY"

Hollow wall anchor

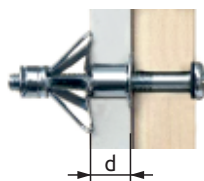

| INDEX | ROZMIAR / SIZE [mm] | | ILOŚĆ [szt.] QUANTITY [pcs] | | CENA / PRICE 1000 szt./pcs [PLN] |
|----------|-----------------------------|---------------|--------------------------------|------|--|
| | | $\geq d \leq$ | | | |
| SM04020 | M4 x 20 | 2-6 | 100 | 2400 | 410,00 |
| SM04032 | M4 x 32 | 3-9 | 100 | 2400 | 415,00 |
| SM04038 | M4 x 38 | 8-16 | 100 | 2400 | 442,00 |
| SM04046 | M4 x 46 | 3-20 | 100 | 2400 | 465,00 |
| SM04059 | M4 x 59 | 31-38 | 100 | 2400 | 545,00 |
| SM05037 | M5 x 37 | 6-13 | 100 | 2400 | 617,00 |
| SM05052 | M5 x 52 | 3-16 | 100 | 1200 | 650,00 |
| SM05065 | M5 x 65 | 16-32 | 100 | 1200 | 690,00 |
| SM05080 | M5 x 80 | 32-45 | 100 | 1200 | 780,00 |
| SM06037 | M6 x 37 | 6-13 | 100 | 1200 | 700,00 |
| SM06052 | M6 x 52 | 3-16 | 100 | 1200 | 772,00 |
| SM06065 | M6 x 65 | 16-32 | 100 | 1200 | 820,00 |
| SM06080 | M6 x 80 | 32-45 | 50 | 600 | 1 100,00 |
| SM08080 | M8 x 80 | 32-45 | 50 | 600 | 1 154,00 |
| SM04032S | hak sufitowy / ceiling hook | 3-9 | 100 | 2400 | 750,00 |
| SM04032K | hak kątowy / hook | 3-9 | 100 | 2400 | 750,00 |
| SM05037S | hak sufitowy / ceiling hook | 6-13 | 100 | 1200 | 1060,00 |
| SM05037K | hak kątowy / hook | 6-13 | 100 | 1200 | 1060,00 |
| SM05052S | hak sufitowy / ceiling hook | 3-16 | 100 | 1200 | 1 120,00 |
| SM05052K | hak kątowy / hook | 3-16 | 100 | 1200 | 1 120,00 |

Kołek do zamocowań w ścianach gipsowo-kartonowych "DRIVA"

Driva pin for plaster walls



| INDEX | MATERIAŁ MATERIAL | ROZMIAR SIZE [mm] | | ILOŚĆ [szt.] QUANTITY [pcs] | | CENA / PRICE 1000 szt./pcs [PLN] |
|----------|-------------------|-------------------|-----|-----------------------------|------|--|
| | | | | | | |
| DRIVA-01 | Poliamid | 14 x 40 | 3,5 | 200 | 4800 | 125,40 |
| DRIVA-02 | ZnAl | 14 x 30 | 4,5 | 500 | 2000 | 555,00 |
| DRIVA-03 | ZnAl | 14 x 40 | 4,0 | 100 | - | 672,00 |
| DRIVA-04 | ZnAl | 14 x 40 | M6 | 100 | - | 630,00 |

Końcówka do wkrętarki DRIVA

Screwdriver bit for spit DRIVA



| INDEX | ILOŚĆ [szt.] QUANTITY [pcs] | CENA / PRICE 1 szt./pcs [PLN] |
|----------|-----------------------------|-------------------------------------|
| DRIVA-KW | 1 | 1,55 |

Kołek rozporowy do pustych przestrzeni

Toggle anchor for empty spaces

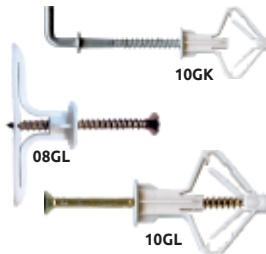

| INDEX | ROZMIAR SIZE [mm] | ILOŚĆ [szt.] QUANTITY [pcs] | | CENA / PRICE 1000 szt./pcs [PLN] |
|------------------------|-------------------|-----------------------------|------|--|
| | | | | |
| 08G (koszulka/plug) | 8 x 40 | 100 | 1200 | 476,00 |
| 08GL (wkręt/screw) | 8 x 40 | 100 | 1200 | 534,00 |
| 08GK (hak kątowy/hook) | 8 x 40 | 100 | 1200 | 797,00 |
| 10G (koszulka/plug) | 10 x 50 | 100 | 1200 | 147,50 |
| 10GL (wkręt/screw) | 10 x 50 | 100 | 1200 | 220,00 |
| 10GK (hak kątowy/hook) | 10 x 50 | 100 | 1200 | 532,00 |

Kotwa sprężynowa do pustych przestrzeni

Toggle anchor for empty spaces, with screw

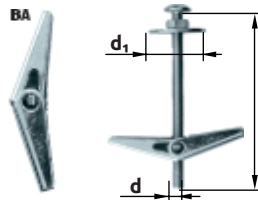

| INDEX | ROZMIAR SIZE [mm] | | | Ø [mm] | ILOŚĆ [szt.] QUANTITY [pcs] | | CENA / PRICE 1000 szt./pcs [PLN] |
|---------|-------------------|----|----------------|--------|-----------------------------|------|--|
| | d | L | d ₁ | | | | |
| SP-04BA | M4 | - | 22 | 14 | 100 | 1000 | 350,00 |
| SP-05BA | M5 | - | 22 | 16 | 100 | 1000 | 380,00 |
| SP-0450 | M4 | 50 | 22 | 14 | 100 | 1000 | 858,00 |
| SP-0580 | M5 | 80 | 22 | 16 | 100 | 1000 | 1 094,00 |

Kotwa sprężynowa do pustych przestrzeni z hakiem otwartym lub zamkniętym

Toggle anchor with ceiling hook, eyehook

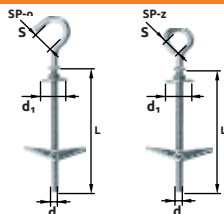

| INDEX | ROZMIAR SIZE [mm] | | | Ø [mm] | ILOŚĆ [szt.] QUANTITY [pcs] | | CENA / PRICE 1000 szt./pcs [PLN] | |
|----------|-------------------|----|----------------|--------|-----------------------------|----|--|----------|
| | d | L | d ₁ | | s | | | |
| SP-0475o | M4 | 75 | 22 | 13 | 14 | 50 | 1000 | 1 110,00 |
| SP-0475z | M4 | 75 | 22 | 18 | 16 | 50 | 1000 | 1 150,00 |
| SP-0590o | M5 | 90 | 22 | 13 | 14 | 50 | 1000 | 1 350,00 |
| SP-0590z | M5 | 90 | 22 | 18 | 16 | 50 | 1000 | 1 400,00 |

Samowierzący wkręt do skręcania profili

Self drilling screws

PN-EN14566 + A1:2012





| INDEX | ROZMIAR SIZE [mm] | MAKSYMALNA PRZEWIERCALNOŚĆ DRILLING CAPACITY [mm] | ILOŚĆ [szt.] QUANTITY [pcs] | | ILOŚĆ [szt./kg] QUANTITY [pcs/kg] | CENA / PRICE | |
|-------------|-------------------|---|-----------------------------|-------|-----------------------------------|--------------|---------------------|
| | | | | | | 1kg [PLN] | 1000 szt./pcs [PLN] |
| WS-3595 | 3,5 x 9,5 | 2,50 | 1000 | 24000 | 855 | 28,50 | 30,20 |
| WS-3911 | 3,9 x 11 | 2,50 | 1000 | 24000 | 1220 | 28,00 | 32,92 |
| WS-3911bw | 3,9 x 11 | 0,75 | 1000 | 24000 | 855 | 27,30 | 32,00 |
| WS-3595oc | 3,5 x 9,5 | 2,50 | 1000 | 24000 | 1220 | 26,95 | 28,55 |
| WS-3911oc | 3,9 x 11 | 2,50 | 1000 | 24000 | 855 | 29,17 | 34,10 |
| WS-3911pcoc | 3,9 x 11 | 2,50 | 1000 | 24000 | 1087 | 33,00 | 34,10 |

Samowierzący wkręt do mocowania płyt gipsowych, maksymalna przewiercalność 2,25 mm

Drywall screws bugle head phillips coarse/ Fine thread harden phosphated

PN-EN14566
+ A1:2012 





| INDEX | ROZMIAR SIZE [mm] | ILOŚĆ [szt.] QUANTITY [pcs] | | ILOŚĆ [szt./kg] QUANTITY [pcs/kg] | CENA / PRICE | |
|---------|----------------------|---|---|--------------------------------------|--------------|------------------------|
| | |  |  | | 1kg [PLN] | 1000 szt./pcs [PLN] |
| WS-3525 | 3,5 x 25 | 1000 | 24000 | 686 | 27,00 | 37,00 |
| WS-3535 | 3,5 x 35 | 1000 | 12000 | 527 | 27,00 | 48,50 |
| WS-3545 | 3,5 x 45 | 500 | 6000 | 412 | 27,00 | 62,30 |
| WS-3555 | 3,5 x 55 | 500 | 6000 | 351 | 27,00 | 74,20 |

Wkręt fosfatowany z gwintem do blachy

Drywall screws bugle head phillips coarse/ fine thread harden phosphated

PN-EN14566
+ A1:2012 





| INDEX | ROZMIAR SIZE [mm] | ILOŚĆ [szt.] QUANTITY [pcs] | | ILOŚĆ [szt./kg] QUANTITY [pcs/kg] | CENA / PRICE | |
|----------|----------------------|---|---|--------------------------------------|--------------|------------------------|
| | |  |  | | 1kg [PLN] | 1000 szt./pcs [PLN] |
| FS-3525 | 3,5 x 25 | 1000 | 24000 | 758 | 17,23 | 26,92 |
| FS-3535 | 3,5 x 35 | 1000 | 12000 | 565 | 16,92 | 34,61 |
| FS-3545 | 3,5 x 45 | 500 | 6000 | 459 | 16,92 | 43,08 |
| FS-3555 | 3,5 x 55 | 500 | 6000 | 388 | 16,92 | 52,30 |
| FS-4270 | 4,2 x 70 | 250 | 3000 | 227 | 16,92 | 87,69 |
| FS-4890 | 4,8 x 90 | 200 | 2400 | 123 | - | 140,00 |
| FS-48100 | 4,8 x 100 | 200 | 2400 | 113 | - | 164,61 |

Wkręt fosfatowany z gwintem do drewna

Drywall screws bugle head phillips coarse/ fine thread harden phosphated

PN-EN14566
+ A1:2012 



| INDEX | ROZMIAR SIZE [mm] | ILOŚĆ [szt.] QUANTITY [pcs] | | ILOŚĆ [szt./kg] QUANTITY [pcs/kg] | CENA / PRICE | |
|----------|----------------------|---|---|--------------------------------------|--------------|------------------------|
| | |  |  | | 1kg [PLN] | 1000 szt./pcs [PLN] |
| FT-3525 | 3,5 x 25 | 1000 | 24000 | 758 | 16,92 | 26,15 |
| FT-3535 | 3,5 x 35 | 1000 | 12000 | 565 | 16,61 | 33,54 |
| FT-3545 | 3,5 x 45 | 500 | 6000 | 459 | 16,61 | 42,46 |
| FT-3555 | 3,5 x 55 | 500 | 6000 | 388 | 16,61 | 50,46 |
| FT-4270 | 4,2 x 70 | 250 | 3000 | 227 | 16,61 | 85,23 |
| FT-4890 | 4,8 x 90 | 200 | 2400 | 123 | 17,38 | 140,00 |
| FT-48100 | 4,8 x 100 | 200 | 2400 | 113 | 18,46 | 164,61 |
| FT-48110 | 4,8 x 110 | 200 | 2400 | 103 | 19,23 | 181,54 |
| FT-48120 | 4,8 x 120 | 200 | 2400 | 91 | 21,07 | 258,46 |
| FT-48140 | 4,8 x 140 | 200 | 2400 | 79 | 23,85 | 336,92 |
| FT-48160 | 4,8 x 160 | 100 | 1200 | 62 | 28,46 | 510,72 |

Metalowy kołek rozporowy do gazobetonu

Metal universal plug for aerated concrete

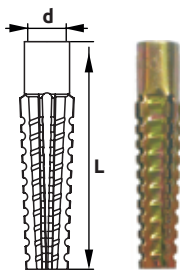

| INDEX | ROZMIAR SIZE [mm] | Ø [mm] | ILOŚĆ [szt.] QUANTITY [pcs] | CENA / PRICE |
|-----------|----------------------|-----------|--------------------------------|--------------|
| | | | | |
| KRG-05030 | 5 x 30 | 4,5 | 200 | 155,00 |
| KRG-06032 | 6 x 32 | 4,5 - 5,0 | 200 | 198,00 |
| KRG-08038 | 8 x 38 | 5,0 - 6,0 | 200 | 215,00 |
| KRG-08060 | 8 x 60 | 5,0 - 6,0 | 200 | 392,00 |
| KRG-10060 | 10 x 60 | 6,0 - 8,0 | 200 | 410,00 |



Kołek do gazobetonu

Universal plug for aerated concrete

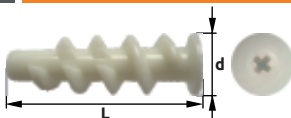

| INDEX | ROZMIAR SIZE [mm] | Ø [mm] | ILOŚĆ [szt.] QUANTITY [pcs] | CENA / PRICE |
|-------|----------------------|--------|--------------------------------|--------------|
| | | | | |
| KGB | 16 x 50 | 4,5 | 100 | 247,00 |

Kotwa wbijana metalowa do płyt GK

Hammer-in fixing for plasterboard

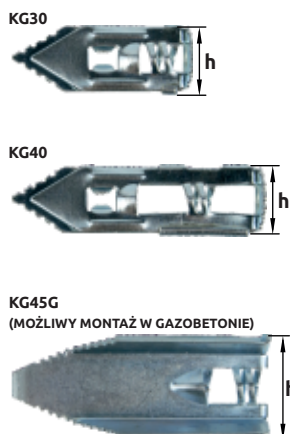

| INDEX | ROZMIAR SIZE [mm] | | | | | ILOŚĆ [szt.] QUANTITY [pcs] | | CENA / PRICE 1000 szt./pcs [PLN] |
|--------------|----------------------|----|----------------|----------------|-------|--------------------------------|-----|--|
| | L | h | d ₁ | L ₁ | b | t _{max} | | |
| KG30 | 30 | 12 | 4,0 | ≥30 | 9÷13 | L ₁ -25 | 200 | 454,00 |
| KG40 | 40 | 12 | 4,0 | ≥40 | 13÷26 | L ₁ -35 | 100 | 542,00 |
| KG45G | 43 | 18 | 4,0 | ≥50 | 13÷26 | L ₁ -40 | 100 | 1120,00 |

Kotwy nie zawierają wkrętów, rekomendowane zastosowanie wkrętów z serii UC40... lub UCT40...
KG30, KG40, KG45G

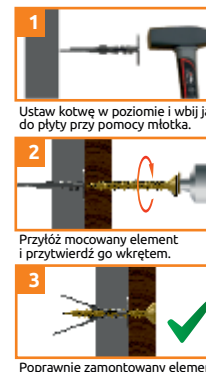
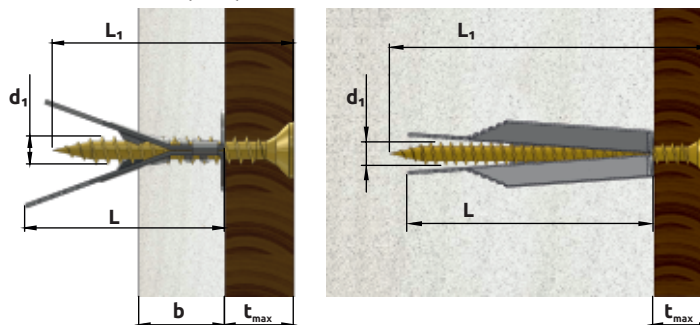

Wkręt fosfatowany z gwintem do drewna na taśmie

Collated phosphate screw for wood



| INDEX | ROZMIAR SIZE [mm] | ILOŚĆ [szt.] QUANTITY [pcs] | | CENA / PRICE 1000 szt./pcs [PLN] |
|----------------|----------------------|--------------------------------|------|--|
| | | | | |
| FTT3525 | 3,5x25 | 50 | 1000 | 83,07 |
| FTT3535 | 3,5x35 | 50 | 1000 | 94,46 |
| FTT3545 | 3,5x45 | 50 | 1000 | 103,85 |
| FTT3555 | 3,5x55 | 50 | 1000 | 114,15 |

Wkręt fosfatowany z gwintem do blachy na taśmie

Collated phosphate screw for sheet metal



| INDEX | ROZMIAR SIZE [mm] | ILOŚĆ [szt.] QUANTITY [pcs] | | CENA / PRICE 1000 szt./pcs [PLN] |
|----------------|----------------------|--------------------------------|------|--|
| | | | | |
| FST3525 | 3,5x25 | 50 | 1000 | 83,07 |
| FST3535 | 3,5x35 | 50 | 1000 | 94,46 |

Wkręt fosfatowany do łączenia płyt gipsowo-kartonowych

Phosphate screw for drywalls

PN-EN14566
+ A1:2012



| INDEX | ROZMIAR SIZE [mm] | ILOŚĆ [szt.] QUANTITY [pcs] | | CENA / PRICE 1000 szt./pcs [PLN] |
|----------------|----------------------|--------------------------------|------|--|
| | | | | |
| FTG5538 | 5,5x38 | 500 | 6000 | 184,61 |

Wkręt fosfatowany HiLo z podwójnym gwintem

Phosphate screw HiLo



| INDEX | ROZMIAR SIZE [mm] | ILOŚĆ [szt.] QUANTITY [pcs] | | CENA / PRICE 1000 szt./pcs [PLN] |
|----------------|----------------------|--------------------------------|-------|--|
| | | | | |
| FSU3919 | 3,9x19 | 1000 | 12000 | 33,85 |
| FSU3925 | 3,9x25 | 1000 | 12000 | 40,00 |
| FSU3930 | 3,9x30 | 1000 | 12000 | 49,23 |
| FSU3935 | 3,9x35 | 1000 | 12000 | 53,84 |
| FSU3940 | 3,9x40 | 500 | 6000 | 58,46 |
| FSU3945 | 3,9x45 | 500 | 6000 | 65,85 |
| FSU3950 | 3,9x50 | 500 | 6000 | 70,00 |
| FSU3955 | 3,9x55 | 500 | 6000 | 73,84 |

Kotek szybkiego montażu do wbijania, z lejkiem

Hammer drive plug with nail contersunk-type

ITB-KOT-2021/1995 wyd. 1



| INDEX | ROZMIAR SIZE [mm] | ILOŚĆ [szt.] QUANTITY [pcs] | | CENA / PRICE 1000 szt./pcs [PLN] |
|--------|----------------------|--------------------------------|------|--|
| | | | | |
| 05L030 | 5 x 30 | 200 | 2400 | 86,00 |
| 05L040 | 5 x 40 | 200 | 2400 | 90,00 |
| 06L040 | 6 x 40 | 200 | 2400 | 91,40 |
| 06L060 | 6 x 60 | 100 | 1200 | 137,50 |
| 06L080 | 6 x 80 | 100 | 1200 | 189,98 |
| 08L045 | 8 x 45 | 100 | 1200 | 160,55 |
| 08L060 | 8 x 60 | 100 | 1200 | 222,15 |
| 08L080 | 8 x 80 | 100 | 1200 | 281,85 |
| 08L100 | 8 x 100 | 50 | 600 | 408,31 |
| 08L120 | 8 x 120 | 50 | 600 | 488,63 |
| 08L140 | 8 x 140 | 50 | 600 | 551,23 |
| 08L160 | 8 x 160 | 50 | 600 | 602,48 |
| 10L080 | 10 x 80 | 50 | 600 | 600,94 |
| 10L100 | 10 x 100 | 50 | 600 | 766,81 |
| 10L120 | 10 x 120 | 50 | 600 | 890,25 |
| 10L140 | 10 x 140 | 50 | 600 | 1 007,46 |
| 10L160 | 10 x 160 | 25 | 300 | 1 166,28 |
| 10L180 | 10 x 180 | 25 | 300 | 1 292,55 |
| 10L200 | 10 x 200 | 25 | 250 | 1 412,91 |

Kotek szybkiego montażu do wbijania, z kotnierzem

Hammer drive plug with nail t-type

ITB-KOT-2021/1995 WYD. 1



| INDEX | ROZMIAR SIZE [mm] | ILOŚĆ [szt.] QUANTITY [pcs] | | CENA / PRICE 1000 szt./pcs [PLN] |
|--------|----------------------|--------------------------------|------|--|
| | | | | |
| 06K040 | 6 x 40 | 200 | 2400 | 94,26 |
| 06K060 | 6 x 60 | 100 | 1200 | 142,46 |
| 06K080 | 6 x 80 | 100 | 1200 | 194,46 |
| 08K060 | 8 x 60 | 100 | 1200 | 244,12 |
| 08K080 | 8 x 80 | 100 | 1200 | 309,72 |
| 08K100 | 8 x 100 | 50 | 600 | 448,68 |

Metalowy kotek do wbijania

Zinc alloy nail in anchor

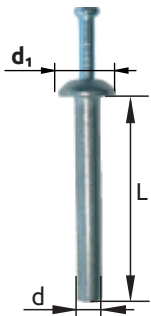

| INDEX | ROZMIAR SIZE [mm] | | | ILOŚĆ [szt.] QUANTITY [pcs] | | CENA / PRICE 1000 szt./pcs [PLN] |
|-----------|----------------------|----|----------------|--------------------------------|------|--|
| | d | L | d ₁ | | | |
| KMW-05020 | 5 | 20 | 12 | 100 | 2400 | 333,85 |
| KMW-06030 | 6 | 30 | 12 | 100 | 2400 | 484,62 |
| KMW-06040 | 6 | 40 | 12 | 100 | 2400 | 523,08 |
| KMW-06050 | 6 | 50 | 12 | 100 | 1200 | 603,08 |
| KMW-06065 | 6 | 65 | 12 | 100 | 1200 | 735,38 |

Kotwa rozprężna wbijana do montażu sufitów podwieszanych

Hammer drive in anchor for suspended ceilings

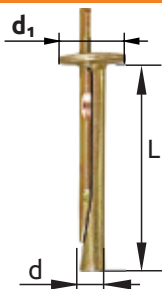

| INDEX | ROZMIAR SIZE [mm] | | | ILOŚĆ [szt.] QUANTITY [pcs] | | CENA / PRICE 1000 szt./pcs [PLN] |
|----------|----------------------|----|----------------|--------------------------------|------|--|
| | d | L | d ₁ | | | |
| GS-06035 | 6 | 35 | 14 | 100 | 1200 | 540,00 |
| GS-06065 | 6 | 65 | 14 | 100 | 1200 | 930,00 |

Kołek z długą płaszczyzną podziału z wkrętem z łbem stożkowym

Frame fixing with countersunk head screw



| INDEX | ROZMIAR SIZE [mm] | | ILOŚĆ [szt.] QUANTITY [pcs] | CENA / PRICE 1 szt./pcs [PLN] |
|----------|----------------------|---------|--------------------------------|-------------------------------------|
| | | | | |
| PX-10100 | 10 x 100 | 6 x 100 | 50 | 0,62 |
| PX-10120 | 10 x 120 | 6 x 120 | 50 | 0,77 |
| PX-10140 | 10 x 140 | 6 x 140 | 50 | 1,16 |
| PX-10160 | 10 x 160 | 6 x 160 | 50 | 1,38 |
| PX-10180 | 10 x 180 | 6 x 180 | 50 | 1,70 |
| PX-10200 | 10 x 200 | 6 x 200 | 50 | 2,12 |
| PX-10220 | 10 x 220 | 6 x 220 | 50 | 4,62 |
| PX-10240 | 10 x 240 | 6 x 240 | 50 | 5,36 |
| PX-10260 | 10 x 260 | 6 x 260 | 50 | 6,10 |
| PX-10280 | 10 x 280 | 6 x 280 | 50 | 6,84 |
| PX-10300 | 10 x 300 | 6 x 300 | 50 | 7,60 |
| PX-12100 | 12 x 100 | 8 x 100 | 50 | 1,46 |
| PX-12120 | 12 x 120 | 8 x 120 | 50 | 1,69 |
| PX-12140 | 12 x 140 | 8 x 140 | 50 | 2,00 |
| PX-12160 | 12 x 160 | 8 x 160 | 50 | 2,36 |
| PX-12180 | 12 x 180 | 8 x 180 | 50 | 2,89 |
| PX-12200 | 12 x 200 | 8 x 200 | 50 | 3,44 |

Kołek z długą płaszczyzną podziału z wkrętem z łbem sześciokątnym

Frame fixing with hexagonal head screw



| INDEX | ROZMIAR SIZE [mm] | | ILOŚĆ [szt.] QUANTITY [pcs] | CENA / PRICE 1 szt./pcs [PLN] |
|----------|----------------------|----------|--------------------------------|-------------------------------------|
| | | | | |
| PK-10100 | 10 x 100 | 6 x 100 | 50 | 0,74 |
| PK-10120 | 10 x 120 | 6 x 120 | 50 | 0,89 |
| PK-10140 | 10 x 140 | 6 x 140 | 50 | 1,16 |
| PK-10160 | 10 x 160 | 6 x 160 | 50 | 1,38 |
| PK-10180 | 10 x 180 | 6 x 180 | 50 | 1,70 |
| PK-10200 | 10 x 200 | 6 x 200 | 50 | 2,12 |
| PK-10220 | 10 x 220 | 6 x 220 | 50 | 3,08 |
| PK-10240 | 10 x 240 | 6 x 240 | 50 | 3,73 |
| PK-10260 | 10 x 260 | 6 x 260 | 50 | 4,20 |
| PK-10280 | 10 x 280 | 6 x 280 | 50 | 4,40 |
| PK-10300 | 10 x 300 | 6 x 300 | 50 | 4,77 |
| PK-12100 | 12 x 100 | 8 x 100 | 50 | 1,14 |
| PK-12120 | 12 x 120 | 8 x 120 | 50 | 1,35 |
| PK-12140 | 12 x 140 | 8 x 140 | 50 | 1,54 |
| PK-12160 | 12 x 160 | 8 x 160 | 50 | 1,72 |
| PK-12180 | 12 x 180 | 8 x 180 | 50 | 2,03 |
| PK-12200 | 12 x 200 | 8 x 200 | 50 | 2,40 |
| PK-12220 | 12 x 220 | 8 x 220 | 50 | 3,37 |
| PK-12240 | 12 x 240 | 8 x 240 | 50 | 4,14 |
| PK-12260 | 12 x 260 | 8 x 260 | 25 | 4,66 |
| PK-12280 | 12 x 280 | 8 x 280 | 25 | 4,89 |
| PK-12300 | 12 x 300 | 8 x 300 | 25 | 5,29 |
| PK-12320 | 12 x 320 | 8 x 320 | 25 | 7,33 |
| PK-12360 | 12 x 360 | 8 x 360 | 25 | 10,17 |
| PK-16100 | 16 x 100 | 12 x 100 | 25 | 2,85 |
| PK-16120 | 16 x 120 | 12 x 120 | 25 | 3,23 |
| PK-16140 | 16 x 140 | 12 x 140 | 25 | 3,67 |
| PK-16160 | 16 x 160 | 12 x 160 | 25 | 4,13 |
| PK-16180 | 16 x 180 | 12 x 180 | 25 | 4,74 |
| PK-16200 | 16 x 200 | 12 x 200 | 25 | 5,21 |
| PK-16220 | 16 x 220 | 12 x 220 | 25 | 5,62 |
| PK-16260 | 16 x 260 | 12 x 260 | 25 | 6,62 |
| PK-16300 | 16 x 300 | 12 x 300 | 25 | 7,60 |

Kotek z długą płaszczyzną podziału z hakiem sufitowym
 Frame fixing with ceiling hook

| INDEX | ROZMIAR SIZE [mm] | | ILOŚĆ [szt.] QUANTITY [pcs] | CENA / PRICE 1 szt./pcs [PLN] |
|-----------|----------------------|---------|--------------------------------|-------------------------------------|
| | | | | |
| PKS-10100 | 10 x 100 | 6 x 100 | 50 | 1,27 |
| PKS-10120 | 10 x 120 | 6 x 120 | 50 | 1,46 |
| PKS-10140 | 10 x 140 | 6 x 140 | 50 | 1,69 |
| PKS-10160 | 10 x 160 | 6 x 160 | 50 | 1,88 |
| PKS-10180 | 10 x 180 | 6 x 180 | 50 | 2,08 |
| PKS-10200 | 10 x 200 | 6 x 200 | 50 | 2,27 |
| PKS-12100 | 12 x 100 | 8 x 100 | 50 | 2,19 |
| PKS-12120 | 12 x 120 | 8 x 120 | 50 | 2,42 |
| PKS-12140 | 12 x 140 | 8 x 140 | 50 | 2,73 |
| PKS-12160 | 12 x 160 | 8 x 160 | 50 | 3,00 |
| PKS-12180 | 12 x 180 | 8 x 180 | 50 | 3,23 |
| PKS-12200 | 12 x 200 | 8 x 200 | 50 | 3,62 |

Kotek z długą płaszczyzną podziału z hakiem prostym
 Frame fixing with hook

| INDEX | ROZMIAR SIZE [mm] | | ILOŚĆ [szt.] QUANTITY [pcs] | CENA / PRICE 1 szt./pcs [PLN] |
|-----------|----------------------|---------|--------------------------------|-------------------------------------|
| | | | | |
| PKH-10100 | 10 x 100 | 6 x 100 | 50 | 1,08 |
| PKH-10120 | 10 x 120 | 6 x 120 | 50 | 1,27 |
| PKH-10140 | 10 x 140 | 6 x 140 | 50 | 1,42 |
| PKH-10160 | 10 x 160 | 6 x 160 | 50 | 1,65 |
| PKH-10180 | 10 x 180 | 6 x 180 | 50 | 1,88 |
| PKH-10200 | 10 x 200 | 6 x 200 | 50 | 2,08 |
| PKH-12100 | 12 x 100 | 8 x 100 | 50 | 1,62 |
| PKH-12120 | 12 x 120 | 8 x 120 | 50 | 1,81 |
| PKH-12140 | 12 x 140 | 8 x 140 | 50 | 2,12 |
| PKH-12160 | 12 x 160 | 8 x 160 | 50 | 2,38 |
| PKH-12180 | 12 x 180 | 8 x 180 | 50 | 2,73 |
| PKH-12200 | 12 x 200 | 8 x 200 | 50 | 3,08 |

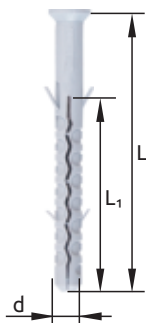

Koszulka kotka z długą płaszczyzną podziału
 Frame plug

| INDEX | ROZMIAR SIZE [mm] | | | ILOŚĆ [szt.] QUANTITY [pcs] | CENA / PRICE 1000 szt./pcs [PLN] |
|-----------|----------------------|-----|----------------|--------------------------------|--|
| | d | L | L ₁ | | |
| KRK-08080 | 8 | 80 | 60 | 100 | 167,92 |
| KRK-08100 | 8 | 100 | 60 | 100 | 186,15 |
| KRK-08120 | 8 | 120 | 60 | 100 | 197,43 |
| KRK-08140 | 8 | 140 | 60 | 100 | 224,19 |
| KRK-08160 | 8 | 160 | 60 | 100 | 243,49 |
| KRK-10080 | 10 | 80 | 60 | 50 | 209,94 |
| KRK-10100 | 10 | 100 | 60 | 50 | 236,64 |
| KRK-10120 | 10 | 120 | 60 | 50 | 262,54 |
| KRK-10140 | 10 | 140 | 60 | 50 | 283,77 |
| KRK-10160 | 10 | 160 | 60 | 50 | 332,00 |
| KRK-10180 | 10 | 180 | 60 | 50 | 389,00 |
| KRK-10200 | 10 | 200 | 60 | 50 | 441,00 |

Kotek z długą płaszczyzną podziału z wkrętem z łbem stożkowym typu POZIDRIVE

Frame fixing with screw





| INDEX | ROZMIAR SIZE [mm] | | ILOŚĆ [szt.] QUANTITY [pcs] | CENA / PRICE 1000 szt./pcs [PLN] |
|-----------|---|---|--------------------------------|--|
| |  |  | | |
| KRD-08080 | 8 x 80 | 5,0 x 85 | 50 | 462,00 |
| KRD-08100 | 8 x 100 | 5,0 x 105 | 50 | 533,00 |
| KRD-08120 | 8 x 120 | 5,0 x 125 | 50 | 626,00 |
| KRD-08140 | 8 x 140 | 5,0 x 145 | 50 | 690,00 |
| KRD-08160 | 8 x 160 | 5,0 x 165 | 50 | 777,00 |
| KRD-10080 | 10 x 80 | 6,8 x 85 | 50 | 823,00 |
| KRD-10100 | 10 x 100 | 6,8 x 100 | 50 | 951,00 |
| KRD-10120 | 10 x 120 | 6,8 x 125 | 50 | 1 072,00 |
| KRD-10140 | 10 x 140 | 6,8 x 145 | 50 | 1 267,00 |
| KRD-10160 | 10 x 160 | 6,8 x 165 | 50 | 1 413,00 |
| KRD-10180 | 10 x 180 | 6,8 x 185 | 50 | 1 910,00 |
| KRD-10200 | 10 x 200 | 6,8 x 205 | 50 | 2 146,00 |

Kotek z długą płaszczyzną podziału z wkrętem z łbem sześciokątnym

Frame fixing with hexagonal head screw



| INDEX | ROZMIAR SIZE [mm] | | ILOŚĆ [szt.] QUANTITY [pcs] | CENA / PRICE 1000 szt./pcs [PLN] |
|----------|---|---|--------------------------------|--|
| |  |  | | |
| KR-08080 | 8 x 80 | 5,0 x 85 | 50 | 579,00 |
| KR-08100 | 8 x 100 | 5,0 x 105 | 50 | 684,00 |
| KR-08120 | 8 x 120 | 5,0 x 125 | 50 | 790,00 |
| KR-08140 | 8 x 140 | 5,0 x 145 | 50 | 890,00 |
| KR-08160 | 8 x 160 | 5,0 x 165 | 50 | 995,00 |
| KR-10080 | 10 x 80 | 6,8 x 85 | 50 | 928,00 |
| KR-10100 | 10 x 100 | 6,8 x 100 | 50 | 1 079,00 |
| KR-10120 | 10 x 120 | 6,8 x 125 | 50 | 1 267,00 |
| KR-10140 | 10 x 140 | 6,8 x 145 | 50 | 1 408,00 |
| KR-10160 | 10 x 160 | 6,8 x 165 | 50 | 1 613,00 |
| KR-10180 | 10 x 180 | 6,8 x 185 | 50 | 1 846,00 |
| KR-10200 | 10 x 200 | 6,8 x 205 | 50 | 2 087,00 |

Wkręt hartowany do mocowania ościeżnic z tłem stożkowym/walcowym TORX 30

Concrete screw

ITB-KOT-2017/0095 wyd. 1

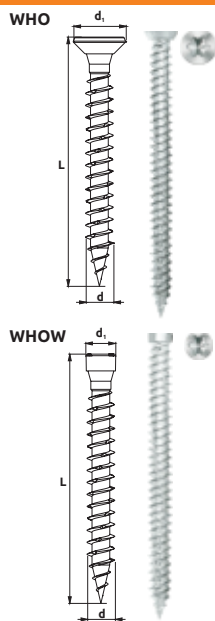

| INDEX | ROZMIAR SIZE [mm] | | | ILOŚĆ [szt.] QUANTITY [pcs] | | GNIAZDO DRIVE | CENA / PRICE 1000 szt./pcs [PLN] |
|------------|----------------------|-----|----------------|--------------------------------|------|------------------|--|
| | d | L | d ₁ | | | | |
| WHO-75052 | 7,5 | 52 | 11,0 | 100 | 1200 | TORX-30 | 228,85 |
| WHO-75072 | 7,5 | 72 | 11,0 | 100 | 800 | TORX-30 | 317,05 |
| WHO-75092 | 7,5 | 92 | 11,0 | 100 | 800 | TORX-30 | 401,71 |
| WHO-75112 | 7,5 | 112 | 11,0 | 100 | 800 | TORX-30 | 484,46 |
| WHO-75132 | 7,5 | 132 | 11,0 | 100 | 800 | TORX-30 | 587,11 |
| WHO-75152 | 7,5 | 152 | 11,0 | 100 | 600 | TORX-30 | 684,86 |
| WHO-75182 | 7,5 | 182 | 11,0 | 100 | 400 | TORX-30 | 828,46 |
| WHO-75202 | 7,5 | 202 | 11,0 | 100 | 400 | TORX-30 | 934,98 |
| WHO-75212 | 7,5 | 212 | 11,0 | 100 | 400 | TORX-30 | 981,75 |
| WHOW-75052 | 7,5 | 52 | 8,3 | 100 | 1200 | TORX-30 | 228,85 |
| WHOW-75072 | 7,5 | 72 | 8,3 | 100 | 800 | TORX-30 | 317,05 |
| WHOW-75092 | 7,5 | 92 | 8,3 | 100 | 800 | TORX-30 | 401,71 |
| WHOW-75112 | 7,5 | 112 | 8,3 | 100 | 800 | TORX-30 | 484,46 |
| WHOW-75132 | 7,5 | 132 | 8,3 | 100 | 800 | TORX-30 | 587,11 |
| WHOW-75152 | 7,5 | 152 | 8,3 | 100 | 600 | TORX-30 | 684,86 |
| WHOW-75182 | 7,5 | 182 | 8,3 | 100 | 400 | TORX-30 | 828,46 |
| WHOW-75202 | 7,5 | 202 | 8,3 | 100 | 400 | TORX-30 | 934,98 |
| WHOW-75212 | 7,5 | 212 | 8,3 | 100 | 400 | TORX-30 | 981,75 |

Kotwa stalowa do ościeżnic

Metal frame anchor



| INDEX | ROZMIAR d x L SIZE d x L [mm] | ILOŚĆ [szt.] QUANTITY [pcs] | GNIAZDO DRIVE | CENA / PRICE 1000 szt./pcs [PLN] |
|---------|----------------------------------|--------------------------------|------------------|--|
| | | | | |
| O-10072 | 10 x 72 | 100 | PZ-3 | 605,31 |
| O-10092 | 10 x 92 | 100 | PZ-3 | 704,71 |
| O-10112 | 10 x 112 | 100 | PZ-3 | 817,37 |
| O-10132 | 10 x 132 | 100 | PZ-3 | 901,38 |
| O-10152 | 10 x 152 | 100 | PZ-3 | 1016,15 |
| O-10182 | 10 x 182 | 100 | PZ-3 | 1168,69 |
| O-10202 | 10 x 202 | 100 | PZ-3 | 1268,09 |

Kotwa stalowa do ościeżnic „KOMBI”

Metal frame anchor



| INDEX | ROZMIAR d x L SIZE d x L [mm] | ILOŚĆ [szt.] QUANTITY [pcs] | GNIAZDO DRIVE | CENA / PRICE 1 szt./pcs [PLN] |
|---------|----------------------------------|--------------------------------|------------------|-------------------------------------|
| | | | | |
| O-112 K | 10 x 112 | 100 | PZ-3 | 1,15 |
| O-132 K | 10 x 132 | 100 | PZ-3 | 1,28 |
| O-152 K | 10 x 152 | 100 | PZ-3 | 1,45 |
| O-182 K | 10 x 182 | 100 | PZ-3 | 1,66 |
| O-202 K | 10 x 202 | 100 | PZ-3 | 1,82 |

Kotwa metalowa do mocowania drewnianej stolarki okiennej i drzwiowej

Mounting anchor for windows

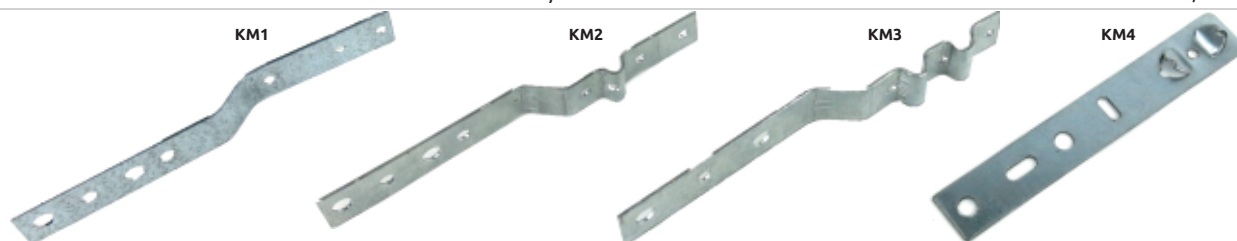

| INDEX | ZASTOSOWANIE APPLICATION | CENA / PRICE 1 szt./pcs [PLN] |
|-------|--|-------------------------------------|
| KM1 | Ościeżnice drzwiowe / Door frames | 2,19 |
| KM2 | Okna drewniane / Wooden windows | 2,19 |
| KM3 | Urzędowski, Sokółka, Wołomin, Włoszczowa | 2,19 |
| KM4 | Okna PVC / PVC windows | 2,19 |



Wkręt hartowany do drewna, płyt wiórowych i PCV (gniazdo PZ, TORX) Chipboard screws countersunk flat

PN-EN 14592+A1:2012 



| INDEX | ROZMIAR SIZE [mm] | ILOŚĆ [szt.] QUANTITY [pcs] | | ILOŚĆ [szt./kg] QUANTITY [pcs/kg] | CENA / PRICE | |
|-------------|----------------------|---|---|--------------------------------------|------------------------|-------------------------|
| | |  |  | | 1000 szt./pcs [PLN] | 1kg (box 10kg) [PLN] |
| UC-2512 *** | 2,5 x 12 | 1000 | 24000 | 3030 | 18,07 | 49,28 |
| UC-2516 | 2,5 x 16 | 1000 | 24000 | 2500 | 20,60 | 46,67 |
| UC-2520 | 2,5 x 20 | 1000 | 24000 | 2220 | 23,08 | 46,67 |
| UC-3012 *** | 3,0 x 12 | 1000 | 24000 | 2270 | 18,38 | 37,67 |
| UC-3016 | 3,0 x 16 | 1000 | 24000 | 1920 | 21,80 | 35,14 |
| UC-3020 | 3,0 x 20 | 1000 | 24000 | 1470 | 25,94 | 35,14 |
| UC-3025 | 3,0 x 25 | 1000 | 12000 | 1330 | 28,56 | 32,13 |
| UC-3030 | 3,0 x 30 | 1000 | 12000 | 1100 | 33,58 | 32,13 |
| UC-3035 | 3,0 x 35 | 1000 | 12000 | 900 | 38,14 | 32,13 |
| UC-3040 | 3,0 x 40 | 1000 | 12000 | 770 | 43,85 | 32,13 |
| UC-3512 *** | 3,5 x 12 | 1000 | 24000 | 1630 | 20,62 | 30,38 |
| UC-3516 *** | 3,5 x 16 | 1000 | 24000 | 1400 | 23,46 | 28,79 |
| UC-3520 | 3,5 x 20 | 1000 | 12000 | 1190 | 26,57 | 26,52 |
| UC-3525 | 3,5 x 25 | 1000 | 12000 | 910 | 31,41 | 26,52 |
| UC-3530 | 3,5 x 30 | 1000 | 12000 | 820 | 37,58 | 26,52 |
| UC-3535 | 3,5 x 35 | 1000 | 12000 | 700 | 39,95 | 24,46 |
| UC-3540 ** | 3,5 x 40 | 1000 | 12000 | 615 | 43,00 | 24,46 |
| UC-3545 ** | 3,5 x 45 | 500 | 6000 | 550 | 49,90 | 24,46 |
| UC-3550 ** | 3,5 x 50 | 500 | 6000 | 515 | 54,32 | 24,46 |
| UC-3560 ** | 3,5 x 60 | 500 | 6000 | 450 | 62,41 | 24,46 |
| UC-4012 *** | 4,0 x 12 | 1000 | 24000 | 1380 | 24,92 | 27,80 |
| UC-4016 *** | 4,0 x 16 | 1000 | 24000 | 1000 | 28,27 | 23,54 |
| UC-4020 *** | 4,0 x 20 | 1000 | 12000 | 805 | 29,93 | 22,92 |
| UC-4025 | 4,0 x 25 | 1000 | 12000 | 705 | 35,58 | 22,92 |
| UC-4030 | 4,0 x 30 | 500 | 6000 | 606 | 41,59 | 22,69 |
| UC-4035 | 4,0 x 35 | 500 | 6000 | 520 | 47,24 | 21,85 |
| UC-4040 ** | 4,0 x 40 | 500 | 6000 | 460 | 51,99 | 21,85 |
| UC-4045 ** | 4,0 x 45 | 500 | 6000 | 420 | 57,11 | 21,85 |
| UC-4050 ** | 4,0 x 50 | 500 | 6000 | 380 | 64,21 | 21,85 |
| UC-4060 ** | 4,0 x 60 | 500 | 6000 | 340 | 75,91 | 21,85 |
| UC-4070 * | 4,0 x 70 | 250 | 3000 | 290 | 86,20 | 21,85 |
| UC-4080 * | 4,0 x 80 | 250 | 3000 | 240 | 96,46 | 21,85 |
| UC-4516 *** | 4,5 x 16 | 500 | 12000 | 750 | 29,91 | 21,85 |
| UC-4520 *** | 4,5 x 20 | 500 | 12000 | 650 | 37,20 | 21,85 |
| UC-4525 | 4,5 x 25 | 500 | 6000 | 560 | 46,00 | 22,95 |
| UC-4530 | 4,5 x 30 | 500 | 6000 | 470 | 54,15 | 22,95 |
| UC-4535 | 4,5 x 35 | 500 | 6000 | 420 | 61,80 | 22,95 |
| UC-4540 | 4,5 x 40 | 500 | 6000 | 360 | 70,51 | 22,95 |
| UC-4545 | 4,5 x 45 | 500 | 6000 | 325 | 73,66 | 21,85 |
| UC-4550 ** | 4,5 x 50 | 500 | 3000 | 310 | 81,75 | 21,85 |
| UC-4560 ** | 4,5 x 60 | 250 | 3000 | 250 | 99,12 | 21,85 |
| UC-4570 * | 4,5 x 70 | 250 | 3000 | 220 | 112,88 | 21,85 |
| UC-4580 * | 4,5 x 80 | 250 | 3000 | 195 | 152,50 | 23,50 |



* wkręt z niepełnym gwintem

** wkręt występuje w dwóch wariantach - pełny i niepełny gwint

*** nie do zastosowań konstrukcyjnych

Wkręt hartowany do drewna, płyt wiórowych i PCV (gniazdo PZ, TORX) Chipboard screws countersunk flat

 PN-EN 14592+A1:2012 

| INDEX | ROZMIAR SIZE [mm] | ILOŚĆ [szt.] QUANTITY [pcs] | | ILOŚĆ [szt./kg] QUANTITY [pcs/kg] | CENA / PRICE | |
|-------------------------|----------------------|---|---|--------------------------------------|------------------------|-------------------------|
| | |  |  | | 1000 szt./pcs [PLN] | 1kg (box 10kg) [PLN] |
| UC-5020 *** | 5,0 x 20 | 500 | 6000 | 495 | 46,19 | 22,31 |
| UC-5025 | 5,0 x 25 | 500 | 6000 | 420 | 54,65 | 22,31 |
| UC-5030 | 5,0 x 30 | 500 | 6000 | 380 | 64,65 | 22,31 |
| UC-5035 | 5,0 x 35 | 500 | 6000 | 320 | 74,10 | 21,85 |
| UC-5040 | 5,0 x 40 | 500 | 6000 | 280 | 84,01 | 21,85 |
| UC-5045 | 5,0 x 45 | 500 | 6000 | 260 | 93,44 | 21,85 |
| UC-5050 ** | 5,0 x 50 | 500 | 6000 | 242 | 101,05 | 21,85 |
| UC-5060 ** | 5,0 x 60 | 250 | 3000 | 205 | 119,16 | 21,85 |
| UC-5070 * | 5,0 x 70 | 250 | 3000 | 175 | 142,79 | 21,85 |
| UC-5080 * | 5,0 x 80 | 200 | 2400 | 156 | 170,06 | 21,85 |
| UC-5090 * | 5,0 x 90 | 200 | 2400 | 142 | 197,49 | 21,85 |
| UC-5100 * | 5,0 x 100 | 200 | 2400 | 126 | 224,44 | 21,85 |
| UC-5110 * | 5,0 x 110 | 100 | 1200 | 117 | 250,80 | 21,85 |
| UC-5120 * | 5,0 x 120 | 100 | 1200 | 108 | 284,97 | 21,85 |
| UC-6030 | 6,0 x 30 | 250 | 3000 | 235 | 98,55 | 21,85 |
| UC-6040 | 6,0 x 40 | 250 | 3000 | 200 | 122,28 | 21,85 |
| UC-6045 | 6,0 x 45 | 250 | 3000 | 181 | 136,20 | 21,85 |
| UC-6050 | 6,0 x 50 | 250 | 3000 | 160 | 148,18 | 21,85 |
| UC-6060 | 6,0 x 60 | 250 | 3000 | 137 | 173,86 | 21,85 |
| UC-6070 ** | 6,0 x 70 | 200 | 2400 | 116 | 202,10 | 21,85 |
| UC-6080 * | 6,0 x 80 | 200 | 2400 | 103 | 221,18 | 21,85 |
| UC-6090 * | 6,0 x 90 | 100 | 1200 | 94 | 253,72 | 21,85 |
| UC-6100 * | 6,0 x 100 | 100 | 1200 | 84 | 274,59 | 21,85 |
| UC-6110 * | 6,0 x 110 | 100 | 1200 | 78 | 307,54 | 21,85 |
| UC-6120 * | 6,0 x 120 | 100 | 1200 | 72 | 361,00 | 22,77 |
| UC-6130 * | 6,0 x 130 | 100 | 1200 | 66 | 393,99 | 23,69 |
| UC-6140 * | 6,0 x 140 | 100 | 1200 | 62 | 425,72 | 23,69 |
| UC-6150 * | 6,0 x 150 | 100 | 1200 | 58 | 516,80 | 23,69 |
| UC-6160 * | 6,0 x 160 | 100 | 1200 | 51 | 652,81 | 23,69 |
| UC-6180 * | 6,0 x 180 | 100 | 1200 | 42 | 787,65 | 25,31 |
| UC-6200 * ^{TX} | 6,0 x 200 | 100 | 1200 | 38 | 924,33 | 29,23 |
| UC-6220 * ^{TX} | 6,0 x 220 | 100 | 1000 | 35 | 1 148,42 | 30,62 |
| UC-6240 * ^{TX} | 6,0 x 240 | 100 | 1000 | 33 | 1 222,99 | 34,62 |
| UC-6260 * ^{TX} | 6,0 x 260 | 100 | 1000 | 31 | 1 360,00 | 36,92 |

* wkręt z niepełnym gwintem



** wkręt występuje w dwóch wariantach - pełny i niepełny gwint

*** nie do zastosowań konstrukcyjnych

^{TX} wkręt z gniazdem TORX-30

Wkręt fosfatowany z gwintem do drewna z tłem podkładkowym Drywall screws bugle head phillips coarse/ fine thread harden phosphated

 PN-EN14566
+ A1:2012 



| INDEX | ROZMIAR SIZE [mm] | ILOŚĆ [szt.] QUANTITY [pcs] | | ILOŚĆ [szt./kg] QUANTITY [pcs/kg] | CENA / PRICE | |
|----------|----------------------|---|---|--------------------------------------|--------------|------------------------|
| | |  |  | | 1kg [PLN] | 1000 szt./pcs [PLN] |
| FTP-4235 | 4,2 x 35 | 250 | 6000 | 758 | 63,55 | 83,85 |
| FTP-4245 | 4,2 x 45 | 250 | 6000 | 565 | 54,20 | 95,90 |
| FTP-4255 | 4,2 x 55 | 250 | 3000 | 459 | 51,80 | 112,82 |

Wkręt z łbem talerzowym do drewna i płyt wiórowych - ocynkowany

Construction flange head screw

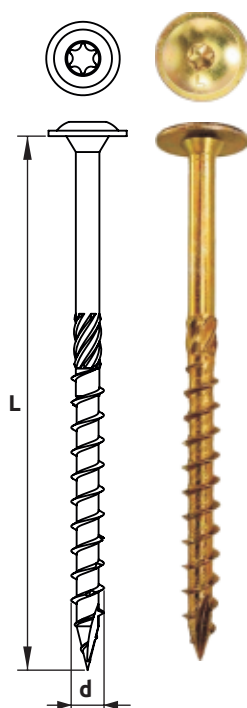
PN-EN 14592+A1:2012 



| INDEX | ROZMIAR d x L SIZE d x L [mm] | ILOŚĆ [szt.] QUANTITY [pcs] | | Gniazdo DRIVE | CENA / PRICE 1000 szt./pcs [PLN] |
|----------------|----------------------------------|---|---|------------------|--|
| | |  |  | | |
| UCSP-06030 *** | 6 x 30 | 100 | 1800 | TORX 30 | 231,98 |
| UCSP-06040 | 6 x 40 | 100 | 1800 | TORX 30 | 273,97 |
| UCSP-06050 | 6 x 50 | 100 | 1800 | TORX 30 | 316,20 |
| UCSP-06060 | 6 x 60 | 100 | 1800 | TORX 30 | 342,70 |
| UCSP-06070 | 6 x 70 | 100 | 1800 | TORX 30 | 373,90 |
| UCSP-06080 | 6 x 80 | 100 | 1800 | TORX 30 | 384,22 |
| UCSP-06100 | 6 x 100 | 100 | 1000 | TORX 30 | 436,12 |
| UCSP-06120 | 6 x 120 | 100 | 1000 | TORX 30 | 574,63 |
| UCSP-06140 | 6 x 140 | 100 | 1000 | TORX 30 | 691,38 |
| UCSP-06160 | 6 x 160 | 100 | 1000 | TORX 30 | 870,77 |
| UCSP-06180 | 6 x 180 | 100 | 1000 | TORX 30 | 1 591,47 |
| UCSP-06200 | 6 x 200 | 100 | 1000 | TORX 30 | 1 710,40 |
| UCSP-06220 | 6 x 220 | 100 | 1000 | TORX 30 | 2 128,32 |
| UCSP-06240 | 6 x 240 | 100 | 1000 | TORX 30 | 2 701,67 |
| UCSP-06260 | 6 x 260 | 100 | 800 | TORX 30 | 2 904,55 |
| UCSP-06280 | 6 x 280 | 50 | 400 | TORX 30 | 3 245,45 |
| UCSP-06300 | 6 x 300 | 50 | 400 | TORX 30 | 3 456,70 |
| UCSP-08060 *** | 8 x 60 | 50 | 400 | TORX 40 | 534,00 |
| UCSP-08080 | 8 x 80 | 50 | 400 | TORX 40 | 560,00 |
| UCSP-08100 | 8 x 100 | 50 | 400 | TORX 40 | 615,51 |
| UCSP-08120 | 8 x 120 | 50 | 400 | TORX 40 | 804,67 |
| UCSP-08140 | 8 x 140 | 50 | 400 | TORX 40 | 863,00 |
| UCSP-08160 | 8 x 160 | 50 | 400 | TORX 40 | 1 021,46 |
| UCSP-08180 | 8 x 180 | 50 | 400 | TORX 40 | 1 256,68 |
| UCSP-08200 | 8 x 200 | 50 | 400 | TORX 40 | 1 423,90 |
| UCSP-08220 | 8 x 220 | 50 | 400 | TORX 40 | 1 686,67 |
| UCSP-08240 | 8 x 240 | 50 | 400 | TORX 40 | 1 838,97 |
| UCSP-08260 | 8 x 260 | 50 | 400 | TORX 40 | 2 148,20 |
| UCSP-08280 | 8 x 280 | 50 | 400 | TORX 40 | 2 388,23 |
| UCSP-08300 | 8 x 300 | 50 | 400 | TORX 40 | 2 797,48 |
| UCSP-08320 | 8 x 320 | 50 | 400 | TORX 40 | 3 795,83 |
| UCSP-08340 | 8 x 340 | 50 | 400 | TORX 40 | 4 141,67 |
| UCSP-08360 | 8 x 360 | 50 | 400 | TORX 40 | 4 671,45 |
| UCSP-08380 | 8 x 380 | 50 | 400 | TORX 40 | 5 124,34 |
| UCSP-08400 | 8 x 400 | 50 | 400 | TORX 40 | 5 649,95 |
| UCSP-08420 | 8 x 420 | 50 | 400 | TORX 40 | 6 500,00 |
| UCSP-10080 | 10 x 80 | 50 | 500 | TORX 40 | 1 118,29 |
| UCSP-10100 | 10 x 100 | 50 | 500 | TORX 40 | 1 345,79 |
| UCSP-10120 | 10 x 120 | 50 | 500 | TORX 40 | 1 710,87 |
| UCSP-10140 | 10 x 140 | 50 | 500 | TORX 40 | 1 999,75 |
| UCSP-10160 | 10 x 160 | 50 | 500 | TORX 40 | 2 286,37 |
| UCSP-10180 | 10 x 180 | 50 | 500 | TORX 40 | 2 617,42 |
| UCSP-10200 | 10 x 200 | 50 | 500 | TORX 40 | 2 946,25 |
| UCSP-10220 | 10 x 220 | 50 | 500 | TORX 40 | 3 288,46 |
| UCSP-10240 | 10 x 240 | 25 | 200 | TORX 40 | 3 666,17 |
| UCSP-10260 | 10 x 260 | 25 | 200 | TORX 40 | 4 060,58 |
| UCSP-10280 | 10 x 280 | 25 | 200 | TORX 40 | 4 513,79 |
| UCSP-10300 | 10 x 300 | 25 | 200 | TORX 40 | 5 082,92 |
| UCSP-10320 | 10 x 320 | 25 | 200 | TORX 40 | 5 344,32 |
| UCSP-10340 | 10 x 340 | 25 | 200 | TORX 40 | 5 874,45 |
| UCSP-10360 | 10 x 360 | 25 | 200 | TORX 40 | 6 343,31 |
| UCSP-10380 | 10 x 380 | 25 | 200 | TORX 40 | 6 976,23 |
| UCSP-10400 | 10 x 400 | 25 | 200 | TORX 40 | 8 432,20 |

*** nie do zastosowań konstrukcyjnych

Wkręt z łbem stożkowym do drewna i płyt wiórowych - ocynkowany
Construction flat head screw

PN-EN 14592+A1:2012 CE

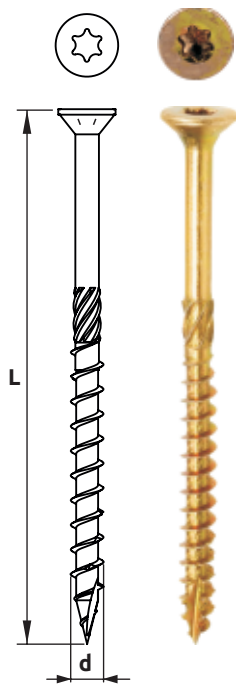

| INDEX | ROZMIAR d x L SIZE d x L [mm] | ILOŚĆ [szt.] QUANTITY [pcs] | GNAZDO DRIVE | CENA / PRICE | |
|--------------|----------------------------------|--------------------------------|-----------------|------------------------|-------------------------|
| | | | | 1000 szt./pcs [PLN] | 1kg (box 10kg) [PLN] |
| UCT-3012 *** | 3,0 x 12 | 1500 | TORX-10 | 22,65 | 44,02 |
| UCT-3016 *** | 3,0 x 16 | 1500 | TORX-10 | 23,53 | 44,02 |
| UCT-3020 *** | 3,0 x 20 | 1500 | TORX-10 | 27,90 | 41,05 |
| UCT-3025 *** | 3,0 x 25 | 1500 | TORX-10 | 33,19 | 37,54 |
| UCT-3030 *** | 3,0 x 30 | 1500 | TORX-10 | 36,54 | 37,54 |
| UCT-3035 *** | 3,0 x 35 | 1500 | TORX-10 | 42,98 | 37,54 |
| UCT-3040 *** | 3,0 x 40 | 1500 | TORX-10 | 48,80 | 37,54 |
| UCT-3530 | 3,5 x 30 | 1000 | TORX-15 | 43,36 | 34,52 |
| UCT-3535 | 3,5 x 35 | 1000 | TORX-15 | 50,64 | 33,21 |
| UCT-3540 | 3,5 x 40 | 1000 | TORX-15 | 53,71 | 33,21 |
| UCT-3550 | 3,5 x 50 | 500 | TORX-15 | 62,82 | 33,21 |
| UCT-4030 | 4,0 x 30 | 500 | TORX-20 | 50,05 | 33,21 |
| UCT-4035 | 4,0 x 35 | 500 | TORX-20 | 58,75 | 32,37 |
| UCT-4040 | 4,0 x 40 | 500 | TORX-20 | 72,83 | 32,37 |
| UCT-4045 | 4,0 x 45 | 500 | TORX-20 | 80,25 | 31,52 |
| UCT-4050 | 4,0 x 50 | 500 | TORX-20 | 88,43 | 31,16 |
| UCT-4060 | 4,0 x 60 | 500 | TORX-20 | 98,50 | 30,66 |
| UCT-4070 | 4,0 x 70 | 250 | TORX-20 | 114,55 | 30,66 |
| UCT-4535 | 4,5 x 35 | 500 | TORX-25 | 73,83 | 30,66 |
| UCT-4540 | 4,5 x 40 | 500 | TORX-25 | 84,28 | 30,66 |
| UCT-4545 | 4,5 x 45 | 500 | TORX-25 | 90,80 | 30,33 |
| UCT-4550 | 4,5 x 50 | 250 | TORX-25 | 97,02 | 30,33 |
| UCT-4560 | 4,5 x 60 | 250 | TORX-25 | 112,77 | 30,15 |
| UCT-4570 | 4,5 x 70 | 250 | TORX-25 | 128,63 | 30,15 |
| UCT-4580 | 4,5 x 80 | 250 | TORX-25 | 145,38 | 30,15 |
| UCT-5040 | 5,0 x 40 | 500 | TORX-25 | 101,37 | 30,46 |
| UCT-5045 | 5,0 x 45 | 500 | TORX-25 | 114,54 | 29,08 |
| UCT-5050 | 5,0 x 50 | 500 | TORX-25 | 121,02 | 29,08 |
| UCT-5060 | 5,0 x 60 | 250 | TORX-25 | 142,31 | 29,08 |
| UCT-5070 | 5,0 x 70 | 250 | TORX-25 | 163,29 | 29,08 |
| UCT-5080 | 5,0 x 80 | 200 | TORX-25 | 186,31 | 29,08 |
| UCT-5090 | 5,0 x 90 | 200 | TORX-25 | 219,02 | 29,08 |
| UCT-5100 | 5,0 x 100 | 200 | TORX-25 | 234,54 | 29,08 |
| UCT-5120 | 5,0 x 120 | 100 | TORX-25 | 292,02 | 29,08 |
| UCT-6050 | 6,0 x 50 | 250 | TORX-30 | 190,63 | 29,08 |
| UCT-6060 | 6,0 x 60 | 250 | TORX-30 | 222,52 | 29,08 |
| UCT-6070 | 6,0 x 70 | 200 | TORX-30 | 254,26 | 29,08 |
| UCT-6080 | 6,0 x 80 | 200 | TORX-30 | 288,98 | 29,08 |
| UCT-6090 | 6,0 x 90 | 100 | TORX-30 | 320,71 | 29,30 |
| UCT-6100 | 6,0 x 100 | 100 | TORX-30 | 366,92 | 29,30 |
| UCT-6120 | 6,0 x 120 | 100 | TORX-30 | 436,17 | 30,66 |
| UCT-6130 | 6,0 x 130 | 100 | TORX-30 | 469,12 | 32,53 |
| UCT-6140 | 6,0 x 140 | 100 | TORX-30 | 519,15 | 34,20 |
| UCT-6150 | 6,0 x 150 | 100 | TORX-30 | 560,95 | 34,20 |
| UCT-6160 | 6,0 x 160 | 100 | TORX-30 | 680,96 | 35,01 |
| UCT-6180 | 6,0 x 180 | 100 | TORX-30 | 860,17 | 35,80 |
| UCT-6200 | 6,0 x 200 | 100 | TORX-30 | 1 049,95 | 35,80 |
| UCT-6220 | 6,0 x 220 | 100 | TORX-30 | 1 217,94 | 42,33 |
| UCT-6240 | 6,0 x 240 | 100 | TORX-30 | 1 513,20 | 46,24 |
| UCT-6260 | 6,0 x 260 | 100 | TORX-30 | 1 611,47 | 49,17 |
| UCT-6280 | 6,0 x 280 | 100 | TORX-30 | 1 830,15 | 60,88 |
| UCT-6300 | 6,0 x 300 | 100 | TORX-30 | 2 191,63 | 60,88 |

*** nie do zastosowań konstrukcyjnych

Wkręt z tłem stożkowym do drewna i płyt wiórowych - ocynkowany

Construction flat head screw

PN-EN 14592+A1:2012 

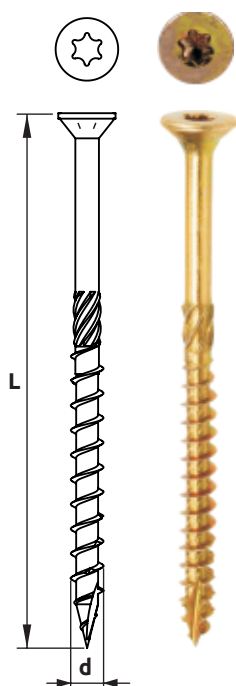

| INDEX | ROZMIAR d x L SIZE d x L [mm] | ILOŚĆ [szt.] QUANTITY [pcs] | GNAZDO DRIVE | CENA / PRICE | |
|-----------|----------------------------------|--------------------------------|-----------------|------------------------|-------------------------|
| | | | | 1000 szt./pcs [PLN] | 1kg (box 10kg) [PLN] |
| UCT-8080 | 8,0 x 80 | 50 | TORX-40 | 588,12 | 37,54 |
| UCT-8100 | 8,0 x 100 | 50 | TORX-40 | 712,79 | 37,54 |
| UCT-8120 | 8,0 x 120 | 50 | TORX-40 | 924,87 | 37,54 |
| UCT-8140 | 8,0 x 140 | 50 | TORX-40 | 1 093,25 | 37,54 |
| UCT-8160 | 8,0 x 160 | 50 | TORX-40 | 1 307,75 | 37,54 |
| UCT-8180 | 8,0 x 180 | 50 | TORX-40 | 1 460,92 | 51,33 |
| UCT-8200 | 8,0 x 200 | 50 | TORX-40 | 1 813,21 | 51,33 |
| UCT-8220 | 8,0 x 220 | 50 | TORX-40 | 2 082,66 | 53,17 |
| UCT-8240 | 8,0 x 240 | 50 | TORX-40 | 2 313,87 | 53,17 |
| UCT-8260 | 8,0 x 260 | 50 | TORX-40 | 2 599,58 | 53,17 |
| UCT-8280 | 8,0 x 280 | 50 | TORX-40 | 2 853,33 | 58,78 |
| UCT-8300 | 8,0 x 300 | 50 | TORX-40 | 3 198,29 | 58,78 |
| UCT-8320 | 8,0 x 320 | 50 | TORX-40 | 3 640,12 | 58,78 |
| UCT-8340 | 8,0 x 340 | 50 | TORX-40 | 3 938,21 | 58,78 |
| UCT-8360 | 8,0 x 360 | 50 | TORX-40 | 4 134,24 | 58,78 |
| UCT-8380 | 8,0 x 380 | 50 | TORX-40 | 4 958,48 | 58,78 |
| UCT-8400 | 8,0 x 400 | 50 | TORX-40 | 6 052,52 | 58,78 |
| UCT-10100 | 10,0 x 100 | 50 | TORX-40 | 1 790,70 | - |
| UCT-10120 | 10,0 x 120 | 50 | TORX-40 | 2 015,66 | - |
| UCT-10140 | 10,0 x 140 | 50 | TORX-40 | 2 215,45 | - |
| UCT-10160 | 10,0 x 160 | 50 | TORX-40 | 2 515,52 | - |
| UCT-10180 | 10,0 x 180 | 50 | TORX-40 | 3 074,69 | - |
| UCT-10200 | 10,0 x 200 | 50 | TORX-40 | 4 050,90 | - |
| UCT-10220 | 10,0 x 220 | 50 | TORX-40 | 4 740,04 | - |
| UCT-10240 | 10,0 x 240 | 50 | TORX-40 | 5 370,06 | - |
| UCT-10260 | 10,0 x 260 | 50 | TORX-40 | 5 707,62 | - |
| UCT-10280 | 10,0 x 280 | 50 | TORX-40 | 6 787,30 | - |
| UCT-10300 | 10,0 x 300 | 25 | TORX-40 | 7 529,96 | - |
| UCT-10320 | 10,0 x 320 | 25 | TORX-40 | 8 477,08 | - |
| UCT-10340 | 10,0 x 340 | 25 | TORX-40 | 9 380,10 | - |
| UCT-10360 | 10,0 x 360 | 25 | TORX-40 | 10 301,82 | - |
| UCT-10380 | 10,0 x 380 | 25 | TORX-40 | 11 144,24 | - |
| UCT-10400 | 10,0 x 400 | 25 | TORX-40 | 11 794,62 | - |

Wkręt tarasowy A2*

Terrace Screw A2

*Towar dostępny od VIII 2023



| INDEX | ROZMIAR SIZE [mm] | GNAZDO DRIVE | ILOŚĆ [szt.] QUANTITY [pcs] | CENA / PRICE | |
|----------|----------------------|-----------------|--------------------------------|------------------------|--|
| | | | | 1000 szt./pcs [PLN] | |
| WKRT4045 | 4,0 x 45 | T15 | 250 | 222,94 | |
| WKRT4050 | 4,0 x 50 | T15 | 250 | 241,03 | |
| WKRT4060 | 4,0 x 60 | T15 | 250 | 281,20 | |
| WKRT4550 | 4,5 x 50 | T20 | 250 | 293,57 | |
| WKRT4560 | 4,5 x 60 | T20 | 250 | 342,88 | |
| WKRT4570 | 4,5 x 70 | T20 | 250 | 392,95 | |
| WKRT4580 | 4,5 x 80 | T20 | 250 | 445,88 | |
| WKRT5050 | 5,0 x 50 | T25 | 250 | 362,49 | |
| WKRT5060 | 5,0 x 60 | T25 | 250 | 425,89 | |
| WKRT5070 | 5,0 x 70 | T25 | 250 | 490,43 | |
| WKRT5080 | 5,0 x 80 | T25 | 250 | 558,02 | |

Wkręt dystansowy*

Distance Screw

*Towar dostępny od VIII 2023



| INDEX | ROZMIAR SIZE [mm] | GNAZDO DRIVE | ILOŚĆ [szt.] QUANTITY [pcs] | CENA / PRICE | |
|----------|----------------------|-----------------|--------------------------------|------------------------|--|
| | | | | 1000 szt./pcs [PLN] | |
| WKRD6080 | 6,0 x 80 | T30 | 200 | 290,00 | |
| WKRD6090 | 6,0 x 90 | T30 | 200 | 321,08 | |
| WKRD6100 | 6,0 x 100 | T30 | 100 | 352,14 | |
| WKRD6120 | 6,0 x 120 | T30 | 100 | 462,78 | |
| WKRD6130 | 6,0 x 130 | T30 | 100 | 494,49 | |
| WKRD6145 | 6,0 x 145 | T30 | 100 | 561,30 | |
| WKRD6160 | 6,0 x 160 | T30 | 100 | 621,09 | |

* towar dostępny VIII 2023

Wkręt do podkładów

Coach screw

DIN 571



ø5mm

ø6mm

ø8mm

| DEŁUGOŚĆ LENGTH [mm] | INDEX | WAGA 1000 szt. WEIGHT 1000 pcs [kg] | CENA / PRICE 1 kg [PLN] | INDEX | WAGA 1000 szt. WEIGHT 1000 pcs [kg] | CENA / PRICE 1 kg [PLN] | INDEX | WAGA 1000 szt. WEIGHT 1000 pcs [kg] | CENA / PRICE 1 kg [PLN] |
|----------------------------|----------|---|---------------------------------|-----------|---|---------------------------------|----------|---|---------------------------------|
| 40 | | | | WDP06040 | 8,2 | 14,23 | WDP08040 | 13,4 | 13,82 |
| 50 | WDP05050 | 7,58 | 16,85 | WDP06050 | 10,1 | 14,23 | WDP08050 | 15,5 | 13,82 |
| 60 | WDP05060 | 8,40 | 16,85 | WDP06060 | 11,5 | 14,23 | WDP08060 | 18,4 | 13,82 |
| 70 | WDP05070 | 9,22 | 16,85 | WDP06070 | 13,0 | 14,23 | WDP08070 | 21,6 | 13,82 |
| 80 | WDP05080 | 10,73 | 16,85 | WDP06080 | 14,1 | 14,23 | WDP08080 | 25,8 | 13,82 |
| | | | | WDP06080+ | 14,1 | 14,23 | | | |
| 90 | | | | | | | WDP08090 | 29,4 | 13,82 |
| 100 | | | | WDP06100 | 17,4 | 14,23 | WDP08100 | 32,2 | 13,82 |
| 120 | | | | WDP06120 | 21,1 | 14,23 | WDP08120 | 37,8 | 13,82 |
| 140 | | | | WDP06140 | 23,1 | 14,23 | WDP08140 | 43,4 | 13,82 |
| 160 | | | | WDP06160 | 26,3 | 15,02 | WDP08160 | 47,2 | 13,82 |
| 180 | | | | WDP06180 | 29,2 | 15,88 | WDP08180 | 54,2 | 14,54 |
| 200 | | | | WDP06200 | 33,3 | 16,45 | WDP08200 | 60,4 | 15,08 |
| 220 | | | | WDP06220 | 37,1 | 16,45 | WDP08220 | 65,7 | 16,92 |
| 240 | | | | | | | WDP08240 | 71,0 | 16,92 |
| 260 | | | | | | | WDP08260 | 76,6 | 16,92 |
| 280 | | | | | | | WDP08280 | 83,2 | 16,92 |
| 300 | | | | | | | WDP08300 | 84,0 | 17,30 |
| 320 | | | | | | | WDP08320 | 85,0 | 21,92 |
| 340 | | | | | | | WDP08340 | 90,1 | 21,92 |
| 360 | | | | | | | WDP08360 | 95,9 | 21,92 |
| 380 | | | | | | | WDP08380 | 101,5 | 21,92 |
| 400 | | | | | | | WDP08400 | 116,4 | 21,92 |

* WDP06080+ - wkręt z łbem sześciokątnym i główką PZ3

ø10mm



ø12mm

| DEŁUGOŚĆ LENGTH [mm] | INDEX | WAGA 1000 szt. WEIGHT 1000 pcs [kg] | CENA / PRICE 1 kg [PLN] | INDEX | WAGA 1000 szt. WEIGHT 1000 pcs [kg] | CENA / PRICE 1 kg [PLN] |
|----------------------------|----------|---|---------------------------------|----------|---|---------------------------------|
| 60 | WDP10060 | 30,0 | 13,82 | | | |
| 80 | WDP10080 | 40,0 | 13,82 | WDP12080 | 61,0 | 14,31 |
| 90 | WDP10090 | 46,4 | 13,82 | | | |
| 100 | WDP10100 | 52,8 | 13,82 | WDP12100 | 76,0 | 14,31 |
| 110 | WDP10110 | 59,2 | 13,82 | | | |
| 120 | WDP10120 | 62,0 | 13,82 | WDP12120 | 93,0 | 14,31 |
| 140 | WDP10140 | 69,0 | 13,82 | WDP12140 | 104,0 | 14,31 |
| 160 | WDP10160 | 79,4 | 13,82 | WDP12160 | 118,0 | 14,31 |
| 180 | WDP10180 | 90,2 | 14,54 | WDP12180 | 129,0 | 14,60 |
| 200 | WDP10200 | 97,8 | 15,08 | WDP12200 | 145,0 | 15,35 |
| 220 | WDP10220 | 106,6 | 16,92 | WDP12220 | 159,0 | 17,85 |
| 240 | WDP10240 | 115,0 | 16,92 | WDP12240 | 174,0 | 17,85 |
| 260 | WDP10260 | 126,7 | 16,92 | WDP12260 | 184,0 | 17,85 |
| 280 | WDP10280 | 137,2 | 16,92 | WDP12280 | 190,0 | 17,85 |
| 300 | WDP10300 | 145,9 | 17,38 | WDP12300 | 196,0 | 17,85 |
| 320 | WDP10320 | 155,8 | 21,92 | | | |
| 340 | WDP10340 | 170,6 | 21,92 | | | |
| 360 | WDP10360 | 182,0 | 21,92 | | | |
| 380 | WDP10380 | 188,2 | 21,92 | | | |
| 400 | WDP10400 | 194,7 | 21,92 | | | |

Łącznik rozporowy pierścieniowy do betonu

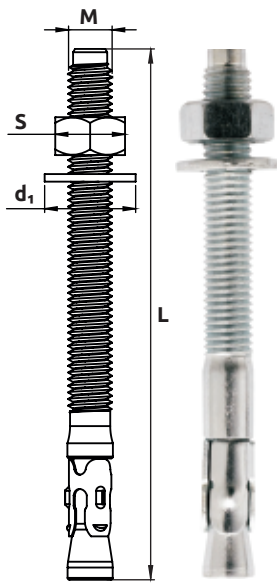
Wedge anchor



| INDEX | ROZMIAR / SIZE [mm] | | | | ILOŚĆ [szt.] QUANTITY [pcs] | | CENA / PRICE 1 szt./pcs [PLN] |
|----------|---------------------|-----|----------------|----|---|---|-------------------------------------|
| | M | L | d ₁ | S |  |  | |
| ŁP-06040 | M6 | 40 | 12 | 10 | 200 | 2000 | 0,34 |
| ŁP-06050 | M6 | 50 | 12 | 10 | 200 | 2000 | 0,40 |
| ŁP-06065 | M6 | 65 | 12 | 10 | 150 | 1500 | 0,46 |
| ŁP-06080 | M6 | 80 | 12 | 10 | 140 | 1400 | 0,55 |
| ŁP-06100 | M6 | 100 | 12 | 10 | 100 | 1000 | 0,65 |
| ŁP-06120 | M6 | 120 | 12 | 10 | 100 | 1000 | 0,74 |
| ŁP-08050 | M8 | 50 | 16 | 13 | 100 | 1000 | 0,58 |
| ŁP-08065 | M8 | 65 | 16 | 13 | 90 | 900 | 0,65 |
| ŁP-08075 | M8 | 75 | 16 | 13 | 80 | 800 | 0,71 |
| ŁP-08085 | M8 | 85 | 16 | 13 | 70 | 700 | 0,77 |
| ŁP-08095 | M8 | 95 | 16 | 13 | 70 | 700 | 0,83 |
| ŁP-08115 | M8 | 115 | 16 | 13 | 50 | 500 | 1,02 |
| ŁP-08130 | M8 | 130 | 16 | 13 | 40 | 400 | 1,11 |
| ŁP-08140 | M8 | 140 | 16 | 13 | 40 | 400 | 1,14 |
| ŁP-08150 | M8 | 150 | 16 | 13 | 40 | 400 | 1,23 |
| ŁP-10065 | M10 | 65 | 20 | 17 | 50 | 500 | 1,05 |
| ŁP-10080 | M10 | 80 | 20 | 17 | 40 | 400 | 1,20 |
| ŁP-10090 | M10 | 90 | 20 | 17 | 35 | 350 | 1,29 |
| ŁP-10105 | M10 | 105 | 20 | 17 | 35 | 350 | 1,42 |
| ŁP-10120 | M10 | 120 | 20 | 17 | 30 | 300 | 1,63 |
| ŁP-10140 | M10 | 140 | 20 | 17 | 30 | 300 | 1,75 |
| ŁP-10150 | M10 | 150 | 20 | 17 | 30 | 300 | 1,88 |
| ŁP-12070 | M12 | 70 | 24 | 19 | 35 | 350 | 1,57 |
| ŁP-12080 | M12 | 80 | 24 | 19 | 30 | 300 | 1,66 |
| ŁP-12090 | M12 | 90 | 24 | 19 | 30 | 300 | 1,82 |
| ŁP-12100 | M12 | 100 | 24 | 19 | 25 | 250 | 2,09 |
| ŁP-12110 | M12 | 110 | 24 | 19 | 25 | 250 | 2,15 |
| ŁP-12120 | M12 | 120 | 24 | 19 | 25 | 250 | 2,25 |
| ŁP-12130 | M12 | 130 | 24 | 19 | 20 | 200 | 2,62 |
| ŁP-12140 | M12 | 140 | 24 | 19 | 20 | 200 | 2,74 |
| ŁP-12160 | M12 | 160 | 24 | 19 | 50 | 200 | 2,92 |
| ŁP-12180 | M12 | 180 | 24 | 19 | 45 | 180 | 3,45 |
| ŁP-12200 | M12 | 200 | 24 | 19 | 35 | 140 | 3,72 |
| ŁP-12220 | M12 | 220 | 24 | 19 | 30 | 120 | 4,43 |
| ŁP-12240 | M12 | 240 | 24 | 19 | 25 | 100 | 4,95 |
| ŁP-16090 | M16 | 90 | 30 | 24 | 25 | 200 | 3,38 |
| ŁP-16100 | M16 | 105 | 30 | 24 | 20 | 160 | 3,63 |
| ŁP-16125 | M16 | 125 | 30 | 24 | 20 | 160 | 4,37 |
| ŁP-16145 | M16 | 145 | 30 | 24 | 15 | 120 | 4,98 |
| ŁP-16160 | M16 | 160 | 30 | 24 | 30 | 120 | 5,45 |
| ŁP-16180 | M16 | 180 | 30 | 24 | 25 | 100 | 6,06 |
| ŁP-16200 | M16 | 200 | 30 | 24 | 25 | 100 | 6,49 |
| ŁP-16220 | M16 | 220 | 30 | 24 | 20 | 80 | 7,68 |
| ŁP-16240 | M16 | 240 | 30 | 24 | 20 | 80 | 8,38 |
| ŁP-16250 | M16 | 250 | 30 | 24 | 20 | 80 | 8,89 |
| ŁP-20100 | M20 | 100 | 37 | 30 | 12 | 96 | 6,66 |
| ŁP-20120 | M20 | 120 | 37 | 30 | 12 | 96 | 7,68 |
| ŁP-20130 | M20 | 130 | 37 | 30 | 10 | 80 | 8,37 |
| ŁP-20160 | M20 | 160 | 37 | 30 | 20 | 80 | 9,80 |
| ŁP-20200 | M20 | 200 | 37 | 30 | 15 | 60 | 11,55 |
| ŁP-20220 | M20 | 220 | 37 | 30 | 15 | 60 | 12,23 |
| ŁP-24180 | M24 | 180 | 44 | 36 | 10 | 40 | 22,77 |

Kotwa opaskowa sufitowa z oczkiem

Ceiling anchor with eye yellow zinc



| INDEX | ROZMIAR SIZE [mm] | ILOŚĆ [szt.] QUANTITY [pcs] | CENA / PRICE 1000 szt./pcs [PLN] |
|-----------|----------------------|--------------------------------|--|
| SRS-06065 | M6 x 65 | 500 | 470,00 |

Kotwa śrubowa Anchor Bolt do betonu z łbem sześciokątnym z podkładką

Anchor Bolt

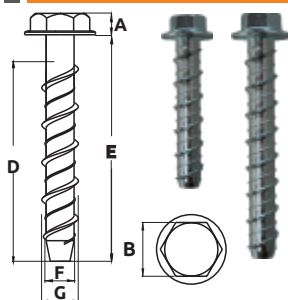

| INDEX | ROZMIAR / SIZE [mm] | | | | | | ILOŚĆ [szt.] QUANTITY [pcs] | CENA / PRICE 1000 szt./pcs [PLN] |
|-----------|---------------------|-------|-------|-----|-------|-------|--------------------------------|--|
| | A | B | C | E | F | G | | |
| FCB-08060 | 8 | 11,75 | 13,25 | 60 | 7,45 | 9,70 | 100 | 2,08 |
| FCB-08075 | 8 | 11,75 | 13,25 | 75 | 7,45 | 9,70 | 50 | 2,34 |
| FCB-08100 | 8 | 11,75 | 13,25 | 100 | 7,45 | 9,70 | 50 | 3,19 |
| FCB-10100 | 10 | 13,75 | 15,50 | 100 | 9,50 | 11,80 | 50 | 4,54 |
| FCB-12100 | 12 | 16,75 | 18,90 | 100 | 11,50 | 14,25 | 25 | 7,26 |
| FCB-12130 | 12 | 16,75 | 18,90 | 130 | 11,50 | 14,25 | 25 | 8,41 |
| FCB-12150 | 12 | 16,75 | 18,90 | 150 | 11,50 | 14,25 | 25 | 9,44 |

Kotwa rozprężna do średnich obciążeń z nakrętką i podkładką / z hakiem sufitowym

Sleeve anchors / Sleeve anchors with ceiling hook

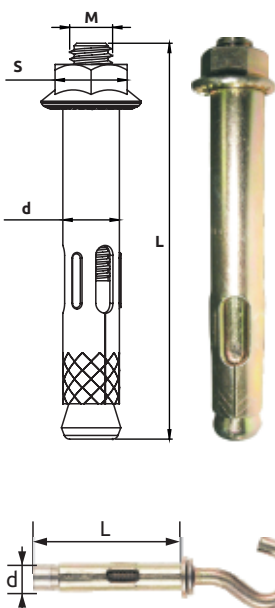

| INDEX | ROZMIAR / SIZE [mm] | | | | ILOŚĆ [szt.] QUANTITY [pcs] | ILOŚĆ [szt.] QUANTITY [pcs] | CENA / PRICE 1000 szt./pcs [PLN] |
|-----------|---------------------|-----|-----|----|--------------------------------|--------------------------------|--|
| | d | L | M | s | | | |
| KT-08045 | 8 | 45 | M6 | 10 | 100 | 1000 | 409,09 |
| KT-08065 | 8 | 65 | M6 | 10 | 50 | 500 | 500,72 |
| KT-08085 | 8 | 85 | M6 | 10 | 50 | 500 | 653,60 |
| KT-10040 | 10 | 40 | M8 | 13 | 50 | 500 | 551,91 |
| KT-10050 | 10 | 50 | M8 | 13 | 50 | 500 | 630,57 |
| KT-10060 | 10 | 60 | M8 | 13 | 50 | 500 | 735,77 |
| KT-10080 | 10 | 80 | M8 | 13 | 50 | 500 | 804,97 |
| KT-10100 | 10 | 100 | M8 | 13 | 50 | 500 | 955,75 |
| KT-10120 | 10 | 120 | M8 | 13 | 50 | 500 | 1 123,89 |
| KT-12060 | 12 | 60 | M10 | 17 | 50 | 250 | 1 046,69 |
| KT-12075 | 12 | 75 | M10 | 17 | 50 | 250 | 1 181,21 |
| KT-12100 | 12 | 100 | M10 | 17 | 50 | 250 | 1 526,54 |
| KT-12130 | 12 | 130 | M10 | 17 | 25 | 125 | 1 778,31 |
| KT-16110 | 16 | 110 | M12 | 19 | 10 | 100 | 2 652,66 |
| KT-16150 | 16 | 150 | M12 | 19 | 10 | 100 | 3 296,55 |
| KT-20110 | 20 | 110 | M16 | 24 | 5 | 50 | 5 783,00 |
| KT-20150 | 20 | 150 | M16 | 24 | 5 | 50 | 7 233,63 |
| KTS-08040 | 8 | 40 | - | - | 50 | 1000 | 847,32 |
| KTS-08060 | 8 | 60 | - | - | 50 | 1000 | 1 110,00 |

Stalowy łącznik jednorozporowy SŁR-1

Steel single-expansion anchor bolt

AT-15-8253/2016

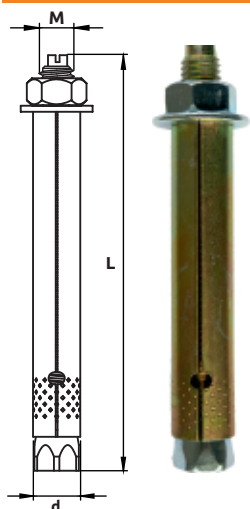

| INDEX | ROZMIAR / SIZE [mm] | | ŚR. ZEWNĘTRZNA OUTER DIAMETER [mm] | ILOŚĆ [szt.] QUANTITY [pcs] | CENA / PRICE 1 szt./pcs [PLN] |
|---------|---------------------|-----|---------------------------------------|--------------------------------|-------------------------------------|
| | L | M | | | |
| J-06060 | 60 | M6 | 10 | 100 | 3,25 |
| J-06080 | 80 | M6 | 10 | 100 | 3,54 |
| J-06100 | 100 | M6 | 10 | 100 | 3,84 |
| J-06120 | 120 | M6 | 10 | 100 | 4,15 |
| J-06150 | 150 | M6 | 10 | 100 | 5,03 |
| J-08050 | 50 | M8 | 12 | 100 | 3,71 |
| J-08060 | 60 | M8 | 12 | 100 | 3,98 |
| J-08080 | 80 | M8 | 12 | 100 | 4,55 |
| J-08100 | 100 | M8 | 12 | 100 | 5,10 |
| J-08120 | 120 | M8 | 12 | 100 | 5,69 |
| J-08150 | 150 | M8 | 12 | 50 | 6,94 |
| J-08180 | 180 | M8 | 12 | 50 | 7,87 |
| J-08210 | 210 | M8 | 12 | 50 | 8,66 |
| J-08250 | 250 | M8 | 12 | 100 | 9,91 |
| J-10060 | 60 | M10 | 14 | 100 | 5,36 |
| J-10080 | 80 | M10 | 16 | 50 | 6,14 |

Stalowy łącznik jednorozporowy SŁR-1

Steel single-expansion anchor bolt

AT-15-8253/2016

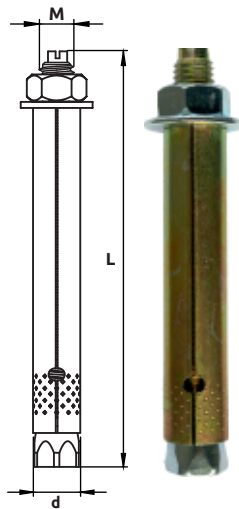

| INDEX | ROZMIAR / SIZE [mm] | | ŚR. ZEWNĘTRZNA OUTER DIAMETER [mm] d | ILOŚĆ [szt.] QUANTITY [pcs] | CENA / PRICE 1 szt./pcs [PLN] |
|---------|---------------------|-----|--|--------------------------------|-------------------------------------|
| | M | L | | | |
| J-10100 | M10 | 100 | 16 | 50 | 6,88 |
| J-10120 | M10 | 120 | 16 | 50 | 7,63 |
| J-10150 | M10 | 150 | 16 | 50 | 9,05 |
| J-10180 | M10 | 180 | 16 | 25 | 10,39 |
| J-10210 | M10 | 210 | 16 | 25 | 11,40 |
| J-10250 | M10 | 250 | 16 | 25 | 12,99 |
| J-10300 | M10 | 300 | 16 | 25 | 15,05 |
| J-12100 | M12 | 100 | 18 | 50 | 7,63 |
| J-12120 | M12 | 120 | 18 | 50 | 8,53 |
| J-12140 | M12 | 140 | 18 | 50 | 9,60 |
| J-12160 | M12 | 160 | 18 | 25 | 10,77 |
| J-12200 | M12 | 200 | 18 | 25 | 12,46 |
| J-12250 | M12 | 250 | 18 | 25 | 14,70 |
| J-12300 | M12 | 300 | 18 | 25 | 17,21 |
| J-16120 | M16 | 120 | 25 | 25 | 22,48 |
| J-16140 | M16 | 140 | 25 | 25 | 24,50 |
| J-16150 | M16 | 150 | 25 | 25 | 24,79 |
| J-16170 | M16 | 170 | 25 | 25 | 26,48 |
| J-16200 | M16 | 200 | 25 | 25 | 30,57 |
| J-16250 | M16 | 250 | 25 | 25 | 34,99 |
| J-16300 | M16 | 300 | 25 | 25 | 37,78 |

Stalowy łącznik dwurozporowy SŁR-2

Steel double-expansion anchor bolt

AT-15-8253/2016

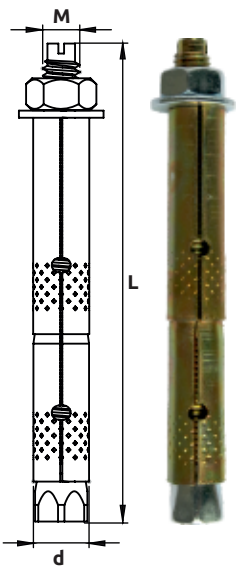

| INDEX | ROZMIAR SIZE [mm] | | ŚR. ZEWN. OUTER DIAMETER [mm] d | CENA / PRICE 1 szt./pcs [PLN] | INDEX | ROZMIAR SIZE [mm] | | ŚR. ZEWN. OUTER DIAMETER [mm] d | CENA / PRICE 1 szt./pcs [PLN] |
|---------|----------------------|-----|--|-------------------------------------|---------|----------------------|-----|--|-------------------------------------|
| | M | L | | | | M | L | | |
| D-06100 | M6 | 100 | 10 | 7,52 | D-16160 | M16 | 160 | 25 | 34,70 |
| D-06150 | M6 | 150 | 10 | 8,46 | D-16180 | M16 | 180 | 25 | 37,20 |
| D-08100 | M8 | 100 | 12 | 8,99 | D-16200 | M16 | 200 | 25 | 42,68 |
| D-08120 | M8 | 120 | 12 | 9,60 | D-16250 | M16 | 250 | 25 | 47,45 |
| D-08150 | M8 | 150 | 12 | 10,64 | D-16300 | M16 | 300 | 25 | 51,82 |
| D-08180 | M8 | 180 | 12 | 11,25 | D-16350 | M16 | 350 | 25 | 55,22 |
| D-08210 | M8 | 210 | 12 | 12,50 | D-16400 | M16 | 400 | 25 | 58,31 |
| D-08250 | M8 | 250 | 12 | 13,85 | D-16450 | M16 | 450 | 25 | 61,25 |
| D-08300 | M8 | 300 | 12 | 15,78 | D-20160 | M20 | 160 | 27 | 38,21 |
| D-10101 | M10 | 100 | 16 | 12,24 | D-20180 | M20 | 180 | 27 | 42,30 |
| D-10121 | M10 | 120 | 16 | 13,10 | D-20200 | M20 | 200 | 27 | 46,25 |
| D-10151 | M10 | 150 | 16 | 14,00 | D-20220 | M20 | 220 | 27 | 49,98 |
| D-10181 | M10 | 180 | 16 | 15,76 | D-20250 | M20 | 250 | 27 | 53,27 |
| D-10211 | M10 | 210 | 16 | 16,70 | D-20260 | M20 | 260 | 27 | 57,40 |
| D-10251 | M10 | 250 | 16 | 18,35 | D-20280 | M20 | 280 | 27 | 61,05 |
| D-10301 | M10 | 300 | 16 | 20,53 | D-20300 | M20 | 300 | 27 | 65,26 |
| D-12100 | M12 | 100 | 18 | 13,22 | D-20350 | M20 | 350 | 27 | 72,47 |
| D-12120 | M12 | 120 | 18 | 14,39 | D-20400 | M20 | 400 | 27 | 80,21 |
| D-12140 | M12 | 140 | 18 | 15,56 | D-20500 | M20 | 500 | 27 | 93,00 |
| D-12160 | M12 | 160 | 18 | 16,75 | D-24160 | M24 | 160 | 32 | 44,40 |
| D-12180 | M12 | 180 | 18 | 17,89 | D-24200 | M24 | 200 | 32 | 60,28 |
| D-12200 | M12 | 200 | 18 | 18,20 | D-24250 | M24 | 250 | 32 | 69,70 |
| D-12210 | M12 | 210 | 18 | 19,04 | D-24300 | M24 | 300 | 32 | 82,40 |
| D-12250 | M12 | 250 | 18 | 20,68 | D-24320 | M24 | 320 | 32 | 91,10 |
| D-12260 | M12 | 260 | 18 | 21,30 | D-24350 | M24 | 350 | 32 | 110,02 |
| D-12300 | M12 | 300 | 18 | 23,87 | D-24400 | M24 | 400 | 32 | 123,25 |
| D-12350 | M12 | 350 | 18 | 25,87 | D-24450 | M24 | 450 | 32 | 145,70 |
| D-12400 | M12 | 400 | 18 | 28,12 | D-24500 | M24 | 500 | 32 | 162,00 |

Tuleja mosiężna

Brass anchor

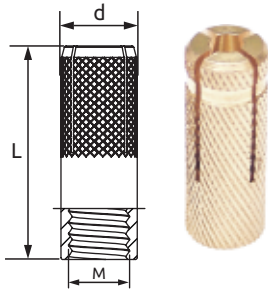

| INDEX | ROZMIAR / SIZE [mm] | | | ILOŚĆ [szt.] QUANTITY [pcs] | | CENA / PRICE 1000 szt./pcs [PLN] |
|-------|---------------------|----|-----|--------------------------------|------|--|
| | d | L | M | | | |
| TM-04 | 5 | 16 | M4 | 100 | 6500 | 360,00 |
| TM-05 | 7 | 20 | M5 | 100 | 3200 | 390,00 |
| TM-06 | 8 | 23 | M6 | 100 | 3900 | 440,00 |
| TM-08 | 10 | 28 | M8 | 50 | 1950 | 660,00 |
| TM-10 | 12 | 32 | M10 | 50 | 1400 | 1 090,00 |
| TM-12 | 15 | 38 | M12 | 25 | 700 | 2 290,00 |
| TM-14 | 18 | 42 | M14 | 25 | 500 | 4 390,00 |
| TM-16 | 20 | 45 | M16 | 25 | 350 | 4 900,00 |

Tuleja stalowa

Drop in anchor

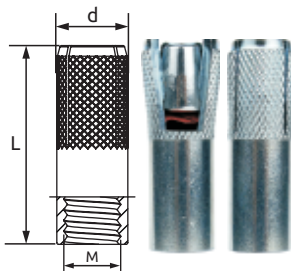

| INDEX | ROZMIAR / SIZE [mm] | | | ILOŚĆ [szt.] QUANTITY [pcs] | | CENA / PRICE 1000 szt./pcs [PLN] |
|-------|---------------------|----|-----|--------------------------------|------|--|
| | d | L | M | | | |
| TS-06 | 8 | 25 | M6 | 100 | 4000 | 320,00 |
| TS-08 | 10 | 30 | M8 | 100 | 2000 | 410,00 |
| TS-10 | 12 | 40 | M10 | 50 | 1000 | 546,00 |
| TS-12 | 16 | 50 | M12 | 50 | 500 | 1 152,00 |
| TS-14 | 18 | 55 | M14 | 35 | 350 | 2 292,00 |
| TS-16 | 20 | 65 | M16 | 25 | 250 | 2 523,00 |
| TS-20 | 25 | 80 | M20 | 25 | 100 | 7 446,00 |

Osadzak do tulei stalowych

Setting tool for steel drop in anchors



| INDEX | ROZMIAR / SIZE [mm] | | ILOŚĆ [szt.] QUANTITY [pcs] | CENA / PRICE 1 szt./pcs [PLN] | CENA / PRICE 1000 szt./pcs [PLN] |
|--------|---------------------|-----|--------------------------------|-------------------------------------|--|
| | m | L | | | |
| OTS-06 | 4,90 | 100 | 1 | 2,08 | 3 360,00 |
| OTS-08 | 6,25 | 100 | 1 | 2,25 | 3 400,00 |
| OTS-10 | 7,90 | 130 | 1 | 3,70 | 7 230,00 |
| OTS-12 | 10,2 | 140 | 1 | 6,50 | 19 969,00 |
| OTS-16 | 13,45 | 190 | 1 | 10,00 | 23 500,00 |

Wiertło do tulei stalowych

Drilling tool for steel drop in anchors

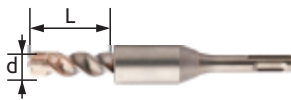

| INDEX | ROZMIAR / SIZE [mm] | | ILOŚĆ [szt.] QUANTITY [pcs] | CENA / PRICE 1 szt./pcs [PLN] |
|-----------|---------------------|----|--------------------------------|-------------------------------------|
| | d | L | | |
| N-SDS08-O | 8 | 27 | 1 | 60,75 |
| N-SDS10-O | 10 | 32 | 1 | 61,80 |
| N-SDS12-O | 12 | 42 | 1 | 87,52 |

Zacisk TKL

Beam clamp

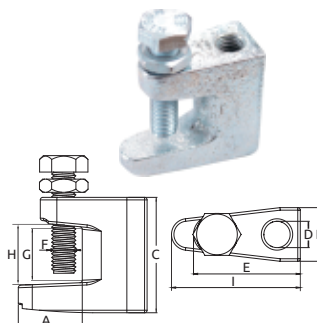

| INDEX | ROZMIAR / SIZE [mm] | | | | | | | | | CENA / PRICE 1 szt./pcs [PLN] |
|-----------|---------------------|------|----|----------------|----|-----|----|------|----|-------------------------------------|
| | A | B | C | D | E | F | G | H | I | |
| TKL08-M08 | 21 | 19 | 35 | M8 | 35 | M8 | 17 | 18,5 | 38 | 6,90 |
| TKL08-D09 | 21 | 19 | 35 | ø9 bez gwintu | 35 | M8 | 17 | 18,0 | 38 | 6,90 |
| TKL10-M08 | 29 | 21 | 45 | M8 | 41 | M10 | 20 | 24,5 | 50 | 6,90 |
| TKL10-M10 | 29 | 21 | 45 | M10 | 41 | M10 | 20 | 24,5 | 50 | 6,90 |
| TKL10-D11 | 29 | 21 | 45 | ø11 bez gwintu | 41 | M10 | 18 | 23,0 | 50 | 6,90 |
| TKL12-M12 | 26 | 29,5 | 58 | M12 | 55 | M12 | 25 | 30,0 | 58 | 12,30 |
| TKL12-M16 | 26 | 29,5 | 58 | M16 | 55 | M12 | 25 | 30,5 | 58 | 24,00 |

Żywica chemiczna bezstyrenowa

Chemical anchors, styrene-free

ETA-11/0396
ETA-15/0560

ETA-09/0140
ETA-09/0246



| INDEX | NAZWA NAME | POJEMNOŚĆ CAPACITY [ml] | ILOŚĆ [szt.] QUANTITY [pcs] | CENA / PRICE 1 szt./pcs [PLN] |
|--------|--|----------------------------|--------------------------------|-------------------------------------|
| KCH001 | Poliestrowa żywica bezstyrenowa / Chemical Anchors Polyester | 300 | 12 | 26,07 |
| KCH002 | Poliestrowa żywica bezstyrenowa / Chemical Anchors Polyester | 400 | 12 | 32,23 |
| KCH003 | Epoksydowo-akrylowa żywica bezstyrenowa / Chemical Anchors Epoxy-acrylate | 300 | 12 | 34,46 |
| KCH004 | Winyloestrowa żywica bezstyrenowa (zimowa) / WINTER Chemical Anchors Vinyl-ester | 300 | 12 | 38,31 |



Pręt gwintowany kl. 5.8 z zakończeniem heksagonalnym

Chemical Anchor Threaded Rod

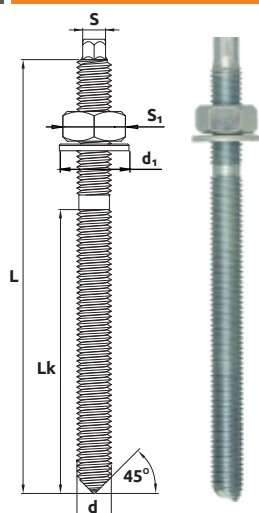

| INDEX | ROZMIAR / SIZE [mm] | | | | | | ILOŚĆ [szt.] QUANTITY [pcs] | CENA / PRICE 1 szt./pcs [PLN] |
|----------|---------------------|-----|-----|----|----------------|----------------|--------------------------------|-------------------------------------|
| | d | L | Lk | S | S ₁ | d ₁ | | |
| KCH08110 | 8 | 110 | 80 | 5 | 13 | 16 | 10 | 1,92 |
| KCH08160 | 8 | 160 | 80 | 5 | 13 | 16 | 10 | 2,06 |
| KCH10130 | 10 | 130 | 90 | 6 | 17 | 20 | 10 | 2,68 |
| KCH10160 | 10 | 160 | 90 | 6 | 17 | 20 | 10 | 3,33 |
| KCH12160 | 12 | 160 | 110 | 8 | 19 | 24 | 10 | 4,80 |
| KCH12210 | 12 | 210 | 110 | 8 | 19 | 24 | 10 | 5,38 |
| KCH16190 | 16 | 190 | 125 | 10 | 24 | 30 | 10 | 9,12 |
| KCH16250 | 16 | 250 | 125 | 10 | 24 | 30 | 10 | 15,48 |
| KCH20260 | 20 | 260 | 170 | 12 | 30 | 37 | 5 | 19,51 |

Tuleja siatkowa

Plastic sleeve

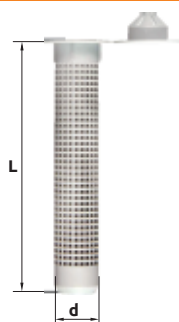

| INDEX | ROZMIAR / SIZE [mm] | | ILOŚĆ [szt.] QUANTITY [pcs] | CENA / PRICE 1 szt./pcs [PLN] |
|--------|---------------------|-----|--------------------------------|-------------------------------------|
| | d | L | | |
| KCH-03 | 12 | 60 | 10 | 0,61 |
| KCH-04 | 15 | 85 | 10 | 0,67 |
| KCH-05 | 15 | 130 | 10 | 0,82 |
| KCH-06 | 20 | 85 | 10 | 0,82 |

Aksesoria

Accessories



| INDEX | NAZWA NAME | ILOŚĆ [szt.] QUANTITY [pcs] | CENA / PRICE 1 szt./pcs [PLN] |
|---------------|--|--------------------------------|-------------------------------------|
| KCH-13 | Mikser mieszający do mas chemicznych / Mixing nozzle | 5 | 1,60 |
| KCH-14 | Pompka do wydmuchiwania zwiercin / Blow out pump | 1 | 50,10 |

Szczotka do czyszczenia otworów

Hole cleaning brush



| INDEX | NAZWA NAME | ILOŚĆ [szt.] QUANTITY [pcs] | CENA / PRICE 1 szt./pcs [PLN] |
|---------------|--|--------------------------------|-------------------------------------|
| KCH-17 | Szczotka do czyszczenia otworów ø13-18mm | 1 | 29,05 |
| KCH-18 | Szczotka do czyszczenia otworów ø19-28mm | 1 | 30,83 |



Łącznik do izolacji z trzpieniem poliamidowym

Connector for insulation with polyamide stud

ETA-20/0849 



i KRÓTKA STREFA ROZPOROWA

| INDEX | DŁUGOŚĆ ŁĄCZNIKA LENGTH [mm] | MAKSYMALNA GRUBOŚĆ MATERIAŁU IZOLACYJNEGO INSULATION MATERIAL THICKNESS [mm] | ILOŚĆ [szt.] QUANTITY [pcs] | | CENA / PRICE 1000 szt./pcs [PLN] |
|---------|---------------------------------|--|---|---|--|
| | | |  |  | |
| ŁIN-070 | 70 | 10-20 | 200 | 14400 | 267,05 |
| ŁIN-090 | 90 | 30-40 | 200 | 14400 | 286,88 |
| ŁIN-100 | 100 | 40-50 | 200 | 14400 | 301,69 |
| ŁIN-120 | 120 | 60-70 | 200 | 12800 | 335,36 |
| ŁIN-140 | 140 | 80-90 | 200 | 12800 | 356,88 |
| ŁIN-160 | 160 | 100-110 | 200 | 9600 | 388,75 |
| ŁIN-180 | 180 | 120-130 | 200 | 9600 | 435,72 |
| ŁIN-200 | 200 | 140-150 | 200 | 8000 | 488,30 |
| ŁIN-220 | 220 | 150-170 | 200 | 8000 | 566,62 |
| ŁIN-260 | 260 | 200-210 | 100 | 4800 | 644,41 |



Łącznik do izolacji z trzpieniem poliamidowym z przedłużoną strefą rozporową

Connector for insulation with polyamide stud with extended expansion zone

ETA-20/0849 



i PRZEDŁUŻONA STREFA ROZPOROWA

| INDEX | DŁUGOŚĆ ŁĄCZNIKA LENGTH [mm] | MAKSYMALNA GRUBOŚĆ MATERIAŁU IZOLACYJNEGO INSULATION MATERIAL THICKNESS [mm] | ILOŚĆ [szt.] QUANTITY [pcs] | | CENA / PRICE 1000 szt./pcs [PLN] |
|----------|---------------------------------|--|---|---|--|
| | | |  |  | |
| ŁIPN-140 | 140 | 50-60 | 200 | 12800 | 429,23 |
| ŁIPN-160 | 160 | 70-80 | 200 | 9600 | 442,52 |
| ŁIPN-180 | 180 | 90-100 | 200 | 9600 | 489,51 |
| ŁIPN-200 | 200 | 110-120 | 200 | 8000 | 540,00 |
| ŁIPN-220 | 220 | 130-140 | 200 | 8000 | 587,69 |
| ŁIPN-260 | 260 | 170-180 | 100 | 4800 | 713,85 |



Łącznik do izolacji z trzpieniem metalowym z łbem z poliamidu

Connector for insulation with metal stud and polyamide head

ETA-20/0849 



i KRÓTKA STREFA ROZPOROWA

| INDEX | DŁUGOŚĆ ŁĄCZNIKA LENGTH [mm] | MAKSYMALNA GRUBOŚĆ MATERIAŁU IZOLACYJNEGO INSULATION MATERIAL THICKNESS [mm] | ILOŚĆ [szt.] QUANTITY [pcs] | | CENA / PRICE 1000 szt./pcs [PLN] |
|----------|---------------------------------|--|---|---|--|
| | | |  |  | |
| ŁIMO-090 | 90 | 30-40 | 200 | 14400 | 673,04 |
| ŁIMO-120 | 120 | 60-70 | 200 | 12800 | 855,85 |
| ŁIMO-140 | 140 | 80-90 | 200 | 12800 | 960,72 |
| ŁIMO-160 | 160 | 100-110 | 200 | 9600 | 1 067,65 |
| ŁIMO-180 | 180 | 120-130 | 200 | 9600 | 1 165,95 |
| ŁIMO-200 | 200 | 140-150 | 200 | 8000 | 1 299,85 |
| ŁIMO-220 | 220 | 150-170 | 200 | 8000 | 1 548,45 |
| ŁIMO-260 | 260 | 200-210 | 100 | 4800 | 1 771,15 |
| ŁIMO-300 | 300 | 240-250 | 100 | | 2 960,00 |
| ŁIMO-350 | 350 | 290-300 | 100 | | 4 900,00 |
| ŁIMO-400 | 400 | 340-350 | 100 | | 6 630,00 |



Łącznik do izolacji z trzpieniem metalowym z łbem z poliamidu z przedłużoną płaszczyzną podziału

Connector for insulation with metal stud with polyamide head and extended parting plane

ETA-20/0849 



i PRZEDŁUŻONA STREFA ROZPOROWA

| INDEX | DŁUGOŚĆ ŁĄCZNIKA LENGTH [mm] | MAKSYMALNA GRUBOŚĆ MATERIAŁU IZOLACYJNEGO INSULATION MATERIAL THICKNESS [mm] | ILOŚĆ [szt.] QUANTITY [pcs] | | CENA / PRICE 1000 szt./pcs [PLN] |
|-----------|---------------------------------|--|---|---|--|
| | | |  |  | |
| ŁIPMO-140 | 140 | 50-60 | 200 | 12800 | 883,76 |
| ŁIPMO-160 | 160 | 70-80 | 200 | 9600 | 971,44 |
| ŁIPMO-180 | 180 | 90-100 | 200 | 9600 | 1 063,58 |
| ŁIPMO-200 | 200 | 110-120 | 200 | 8000 | 1 299,85 |
| ŁIPMO-220 | 220 | 130-140 | 200 | 8000 | 1 627,69 |
| ŁIPMO-260 | 260 | 170-180 | 100 | 4800 | 1 863,08 |
| ŁIPMO-300 | 300 | 210-220 | 100 | | 2 960,00 |
| ŁIPMO-350 | 350 | 260-270 | 100 | | 4 900,00 |
| ŁIPMO-400 | 400 | 310-320 | 100 | | 6 630,00 |

Frez do wiercenia otworów

Cutter for holes

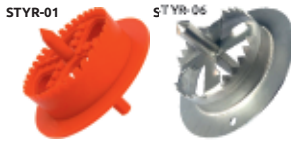

| INDEX | ŚREDNICA DIAMETER [mm] | RODZAJ TYPE | ILOŚĆ [szt.] QUANTITY [pcs] | CENA / PRICE 1 szt./pcs [PLN] |
|---------|---------------------------|-----------------------|--------------------------------|------------------------------------|
| STYR-01 | 67 | styropian / styrofoam | 1 | 11,00 |
| STYR-06 | 65 | wełna / mineral wool | 1 | 160,00 |

Zaślepka styropianowa / wełniana

Styrofoam / mineral wool plug

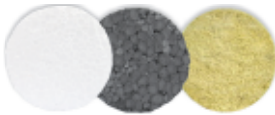

| INDEX | ŚREDNICA DIAMETER [mm] | KOLOR COLOR | ILOŚĆ [szt.] QUANTITY [pcs] | | CENA / PRICE 1000 szt./pcs [PLN] |
|---------|---------------------------|----------------------|--------------------------------|------|---------------------------------------|
| STYR-02 | 67 | biały / white | 100 | 2000 | 121,54 |
| STYR-03 | 67 | grafit / graphite | 100 | 2000 | 169,23 |
| STYR-05 | 65 | wełna / mineral wool | 100 | 2000 | 723,08 |

Kołnierz dociskowy z zaślepką

Pressure flange with a plug



| INDEX | ŚREDNICA DIAMETER [mm] | MIN. ZAKOTWIENIE W DREWNI MINIMAL ANCHORAGE IN WOOD [mm] | ROZMIAR SIZE [mm] | ILOŚĆ [szt.] QUANTITY [pcs] | CENA / PRICE 1000 szt./pcs [PLN] |
|-------|---------------------------|---|----------------------|--------------------------------|---------------------------------------|
| ŁIK | 60 | 20 | 4,8 - 6,0 | 500 | 305,00 |

* PRODUKT NIE ZAWIERA WIDOCZNEGO NA ZDJĘCIU WKRĘTA
* THE PRODUCT DOES NOT CONTAIN THE SCREW SHOWN IN THE ILLUSTRATION

Talerzyk dociskowy do mocowania wełny

Pressure plate for fastening wool



| INDEX | ŚREDNICA DIAMETER [mm] | ILOŚĆ [szt.] QUANTITY [pcs] | CENA / PRICE 1000 szt./pcs [PLN] |
|----------------------|---------------------------|--------------------------------|---------------------------------------|
| KWL-140 polipropylen | 140 | 300 | 489,00 |
| KWL-140 poliamid | 140 | 300 | 900,00 |

Dybel do mocowania w fasadzie ocieplonej styropianem lub wełną (polipropylen/poliamid)

Pin for fastening in the insulation thermally insulated (polypropylene/polyamide)



| INDEX | TWORZYWO MATERIAL | ROZMIAR / SIZE [mm] | | | | ILOŚĆ [szt.] QUANTITY [pcs] | | CENA / PRICE 1000 szt./pcs [PLN] |
|--------|-------------------------------|---------------------|----|-----|------------|--|--|---------------------------------------|
| | | d | L | | | D _{min} | D _{max} | |
| PFI-50 | polipropylen polypropylene | 25 | 50 | T40 | 4,5 5,0 | 35+h _{ef} 30+h _{ef} | 45+h _{ef} 45+h _{ef} | 50 600 780,00 |
| PFI-90 | polipropylen polypropylene | 25 | 90 | T40 | 4,5 5,0 | 35+h _{ef} 30+h _{ef} | 80+h _{ef} 70+h _{ef} | 25 300 1250,00 |



| | | | | | | | | |
|---------|-----------------------|----|----|-----|------------|--|--|----------------|
| PFI-50N | poliamid polyamide | 25 | 50 | T40 | 4,0 4,5 | 30+h _{ef} 30+h _{ef} | 45+h _{ef} 45+h _{ef} | 50 600 1000,00 |
| PFI-90N | poliamid polyamide | 25 | 90 | T40 | 4,0 4,5 | 30+h _{ef} 30+h _{ef} | 80+h _{ef} 70+h _{ef} | 25 300 1600,00 |

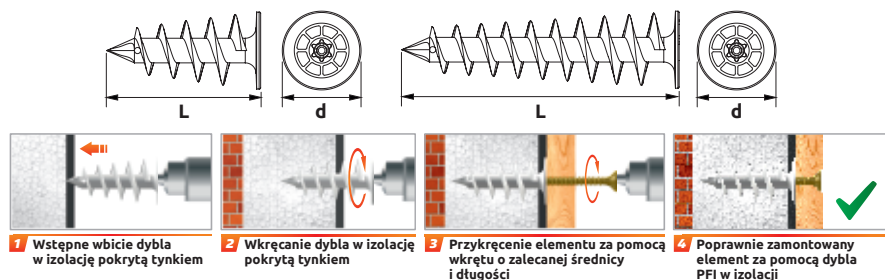
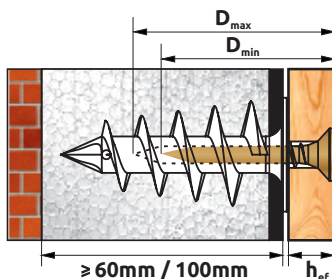

Hak do rusztowań - stal galwanicznie ocynkowana

Eye bolt white zinc plated, welded, thread for wood/metric

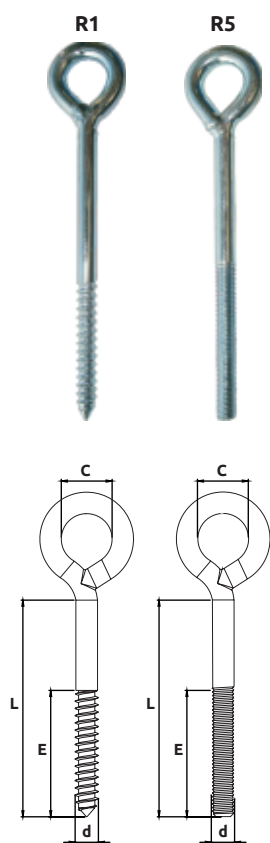

| INDEX | ROZMIAR SIZE [mm] | | | | ILOŚĆ [szt.] QUANTITY [pcs] | CENA / PRICE 1 szt./pcs [PLN] | |
|-----------|----------------------|-----|----|----|--------------------------------|----------------------------------|----------------------------------|
| | d | L | E | C | | DREWNO R1 WOOD R1 | METRYCZNY R5 METRIC THREAD R5 |
| HRR-08090 | 8 | 90 | 54 | 20 | 25 | 2,09 | 2,43 |
| HRR-08100 | 8 | 100 | 54 | 20 | 25 | | 2,49 |
| HRR-08120 | 8 | 120 | 54 | 20 | 25 | 2,46 | 2,66 |
| HRR-08150 | 8 | 150 | 54 | 20 | 25 | | 2,86 |
| HRR-08160 | 8 | 160 | 54 | 20 | 25 | 2,69 | 3,02 |
| HRR-08180 | 8 | 180 | 54 | 20 | 25 | | 3,18 |
| HRR-08190 | 8 | 190 | 54 | 20 | 25 | 2,97 | |
| HRR-08200 | 8 | 200 | 54 | 20 | 25 | | 3,37 |
| HRR-08230 | 8 | 230 | 54 | 20 | 25 | | |
| HRR-08260 | 8 | 260 | 54 | 20 | 25 | | |
| HRR-10090 | 10 | 90 | 65 | 20 | 25 | 2,85 | |
| HRR-10120 | 10 | 120 | 65 | 20 | 25 | 3,18 | 3,55 |
| HRR-10160 | 10 | 160 | 65 | 20 | 25 | 3,69 | 4,06 |
| HRR-10190 | 10 | 190 | 65 | 20 | 25 | 3,90 | 4,48 |
| HRR-10230 | 10 | 230 | 65 | 20 | 25 | 4,33 | 4,95 |
| HRR-10260 | 10 | 260 | 65 | 20 | 25 | 4,67 | 5,20 |
| HRR-10300 | 10 | 300 | 65 | 20 | 25 | 5,28 | 5,89 |
| HRR-10350 | 10 | 350 | 65 | 20 | 25 | 5,85 | |
| HRR-12090 | 12 | 90 | 65 | 24 | 25 | 3,77 | 3,98 |
| HRR-12120 | 12 | 120 | 65 | 24 | 25 | 4,18 | 4,45 |
| HRR-12160 | 12 | 160 | 65 | 24 | 25 | 4,68 | 5,25 |
| HRR-12190 | 12 | 190 | 65 | 24 | 25 | 5,38 | 5,72 |
| HRR-12230 | 12 | 230 | 65 | 24 | 25 | 6,00 | 6,85 |
| HRR-12250 | 12 | 250 | 65 | 24 | 25 | | |
| HRR-12260 | 12 | 260 | 65 | 24 | 25 | 6,60 | 7,65 |
| HRR-12300 | 12 | 300 | 65 | 24 | 25 | 7,28 | 8,25 |
| HRR-12350 | 12 | 350 | 65 | 24 | 25 | 8,05 | 9,38 |
| HRR-12400 | 12 | 400 | 65 | 24 | 25 | 9,44 | |
| HRR-12450 | 12 | 450 | 65 | 24 | 25 | 10,23 | |
| HRR-12500 | 12 | 500 | 65 | 24 | 25 | 11,20 | |

Gwoździe utwardzane

Hardened steel nails white zinc plated



| INDEX | ROZMIAR SIZE [mm] | ILOŚĆ [szt.] QUANTITY [pcs] | | CENA / PRICE 100 szt./pcs [PLN] |
|--------|----------------------|--------------------------------|------|---------------------------------------|
| | | | | |
| GU-030 | 3,0 x 30 | 100 | 3000 | 7,82 |
| GU-040 | 3,0 x 40 | 100 | 3000 | 9,54 |
| GU-050 | 3,0 x 50 | 100 | 1200 | 11,65 |
| GU-060 | 3,0 x 60 | 100 | 1200 | 13,45 |
| GU-070 | 3,0 x 70 | 100 | 1200 | 15,12 |
| GU-080 | 3,0 x 80 | 100 | 1200 | 16,45 |
| GU-100 | 3,5 x 100 | 100 | 800 | 24,58 |
| GU-125 | 4,0 x 125 | 100 | 800 | 32,62 |

Gwoździe utwardzane walcowane

Hardened steel nail grooved shank white zinc plated



| INDEX | ROZMIAR SIZE [mm] | ILOŚĆ [szt.] QUANTITY [pcs] | | CENA / PRICE 250 szt./pcs [PLN] |
|--------|----------------------|--------------------------------|------|---------------------------------------|
| | | | | |
| GUW-25 | 2,7 x 25 | 250 | 3000 | 11,12 |
| GUW-30 | 2,7 x 30 | 250 | 3000 | 12,38 |
| GUW-40 | 2,7 x 40 | 250 | 3000 | 15,81 |
| GUW-41 | 3,5 x 40 | 250 | 3000 | 25,23 |
| GUW-50 | 3,5 x 50 | 250 | 3000 | 30,77 |
| GUW-60 | 3,5 x 60 | 250 | 3000 | 36,12 |
| GUW-70 | 4,5 x 70 | 250 | 1500 | 69,04 |

Gwoździe utwardzane walcowane z podkładką

Hardened steel nail grooved shank with washer white zinc plated



| INDEX | ROZMIAR SIZE [mm] | ILOŚĆ [szt.] QUANTITY [pcs] | | CENA / PRICE 250 szt./pcs [PLN] |
|--------|----------------------|--------------------------------|------|---------------------------------------|
| | | | | |
| GUP-20 | 3,5 x 20 | 250 | 3000 | 39,56 |
| GUP-25 | 3,5 x 25 | 250 | 3000 | 41,54 |
| GUP-30 | 3,5 x 30 | 250 | 3000 | 43,46 |
| GUP-35 | 3,5 x 35 | 250 | 3000 | 47,12 |
| GUP-40 | 3,5 x 40 | 250 | 2000 | 49,80 |
| GUP-50 | 3,5 x 50 | 250 | 2000 | 53,71 |
| GUP-65 | 3,5 x 65 | 250 | 1500 | 71,45 |
| GUP-70 | 3,5 x 70 | 250 | 1500 | 79,69 |

Gwoździe stolarskie - ocynkowane

Finishing nail, yellow zinc plated

DIN 1152



| INDEX | ROZMIAR SIZE [mm] | ILOŚĆ QUANTITY [kg] | | CENA / PRICE 1kg [PLN] |
|----------|----------------------|------------------------|----|------------------------------|
| | | | | |
| GSO-1420 | 1,4 x 20 | 1 | 25 | 24,30 |
| GSO-1425 | 1,4 x 25 | 1 | 25 | 24,30 |
| GSO-1630 | 1,6 x 30 | 1 | 25 | 21,38 |
| GSO-1835 | 1,8 x 35 | 1 | 25 | 19,23 |
| GSO-2040 | 2,0 x 40 | 1 | 25 | 18,77 |
| GSO-2250 | 2,2 x 50 | 1 | 25 | 18,77 |
| GSO-2560 | 2,5 x 60 | 1 | 25 | 18,77 |

Gwoździe stolarskie - miedziane

Finishing nail, copper plated

DIN 1152



| INDEX | ROZMIAR SIZE [mm] | ILOŚĆ QUANTITY [kg] | | CENA / PRICE 1kg [PLN] |
|----------|----------------------|------------------------|----|------------------------------|
| | | | | |
| GSM-1420 | 1,4 x 20 | 1 | 25 | 30,74 |
| GSM-1425 | 1,4 x 25 | 1 | 25 | 30,74 |
| GSM-1630 | 1,6 x 30 | 1 | 25 | 30,00 |
| GSM-1835 | 1,8 x 35 | 1 | 25 | 29,70 |
| GSM-2040 | 2,0 x 40 | 1 | 25 | 29,53 |
| GSM-2250 | 2,2 x 50 | 1 | 25 | 29,08 |
| GSM-2560 | 2,5 x 60 | 1 | 25 | 28,46 |

Gwoździe budowlane czarne

Common nails



| INDEX | ROZMIAR SIZE [mm] | CENA / PRICE | |
|------------|----------------------|--------------|---------------------------------|
| | | 1kg [PLN] | 1kg (opak./box 5kg) [PLN] |
| GWBU-2040 | 2,0 x 40 | 16,77 | 13,38 |
| GWBU-2250 | 2,2 x 50 | 16,47 | 13,08 |
| GWBU-2560 | 2,5 x 60 | 14,23 | 12,00 |
| GWBU-3070 | 3,0 x 70 | 14,23 | 11,83 |
| GWBU-3080 | 3,0 x 80 | 14,23 | 11,83 |
| GWBU-3590 | 3,5 x 90 | 14,23 | 11,83 |
| GWBU-40100 | 4,0 x 100 | 14,23 | 11,83 |
| GWBU-45125 | 4,5 x 125 | 14,23 | 12,29 |
| GWBU-50150 | 5,0 x 150 | 17,23 | 12,29 |
| GWBU-60175 | 6,0 x 175 | - | 12,29 |
| GWBU-60200 | 6,0 x 200 | - | 14,45 |
| GWBU-70225 | 7,0 x 225 | - | 14,45 |
| GWBU-80250 | 8,0 x 250 | - | 14,45 |
| GWBU-80275 | 8,0 x 275 | - | 14,45 |
| GWBU-80300 | 8,0 x 300 | - | 14,45 |

Gwoździe "ANCHOR" ocynkowane elektrolitycznie, do mocowania elementów złącz ciesielskich, różnych elementów drewnianych oraz haków dachowych do konstrukcji drewnianych.

Steel nails "Anchor" electro white zinc plated



| INDEX | ROZMIAR SIZE [mm] | ILOŚĆ QUANTITY [kg] | | CENA / PRICE 1kg [PLN] |
|----------|----------------------|------------------------|----|------------------------------|
| | | | | |
| GKA-4035 | 4,0 x 35 | 1 | 12 | 18,00 |
| GKA-4040 | 4,0 x 40 | 1 | 12 | 18,00 |
| GKA-4050 | 4,0 x 50 | 1 | 12 | 18,00 |
| GKA-4060 | 4,0 x 60 | 1 | 12 | 18,00 |
| GKA-4075 | 4,0 x 75 | 1 | 8 | 18,00 |
| GKA-4100 | 4,0 x 100 | 1 | 8 | 18,00 |
| GKA-4125 | 4,0 x 125 | 1 | 8 | 18,00 |

Gwoździe papowe z podkładką do zamocowań pap izolacyjnych, cienkich blach

Roofing nails with washers



| INDEX | ROZMIAR SIZE [mm] | KOLOR COLOR | ILOŚĆ QUANTITY [kg] | | CENA / PRICE 1kg [PLN] |
|-----------|----------------------|----------------|------------------------|----|------------------------------|
| | | | | | |
| GWPAP3025 | 3,0 X 25 | ocynk / zinc | 5 | 20 | 19,46 |
| GWPAP3030 | 3,0 X 30 | ocynk / zinc | 5 | 20 | 19,46 |

Gwoździe papowe do zamocowań pap izolacyjnych, cienkich blach

Roofing nails



| INDEX | ROZMIAR SIZE [mm] | KOLOR COLOR | ILOŚĆ QUANTITY [kg] | | CENA / PRICE 1kg [PLN] |
|------------|----------------------|----------------|------------------------|----|------------------------------|
| | | | | | |
| GWPA3020 | 3,0 X 20 | ocynk / zinc | 5 | 20 | 17,23 |
| GWPA3020cz | 3,0 X 20 | czarne / black | 5 | 20 | 15,61 |
| GWPA3025 | 3,0 X 25 | ocynk / zinc | 5 | 20 | 17,23 |
| GWPA3025cz | 3,0 X 25 | czarne / black | 5 | 20 | 15,61 |
| GWPA3030 | 3,0 X 30 | ocynk / zinc | 5 | 20 | 17,23 |
| GWPA3030cz | 3,0 X 30 | czarne / black | 5 | 20 | 15,61 |
| GWPA3035 | 3,0 X 35 | ocynk / zinc | 5 | 20 | 17,23 |
| GWPA3035cz | 3,0 X 35 | czarne / black | 5 | 20 | 15,61 |
| GWPA3040 | 3,0 X 40 | ocynk / zinc | 5 | 20 | 17,23 |
| GWPA3040cz | 3,0 X 40 | czarne / black | 5 | 20 | 15,61 |

Gwoździe skręte ocynkowane ogniwo o podwyższonej sile wyciągnięcia do mocowania gontów bitumicznych oraz fasad z tworzyw sztucznych do konstrukcji drewnianych

Square twisted nails



| INDEX | ROZMIAR SIZE [mm] | ILOŚĆ QUANTITY [kg] | CENA / PRICE | |
|---------|----------------------|------------------------|---------------|--|
| | | | 1 kg [PLN] | 1 kg (opak. 5kg / box 5kg) [PLN] |
| GWS-030 | 3,5 x 30 | 5 | 29,00 | 28,00 |

Gwoździe skręte

Square twisted nails



| INDEX | ROZMIAR SIZE [mm] | ILOŚĆ QUANTITY [kg] | CENA / PRICE | |
|---------|----------------------|------------------------|---------------|--|
| | | | 1 kg [PLN] | 1 kg (opak. 5kg / box 5kg) [PLN] |
| GWS-080 | 3,0 x 80 | 5 | 29,00 | 28,00 |
| GWS-090 | 3,0 x 90 | 5 | 29,00 | 28,00 |
| GWS-100 | 4,0 x 100 | 5 | 29,00 | 28,00 |
| GWS-125 | 4,5 x 125 | 5 | 29,00 | 28,00 |
| GWS-150 | 4,5 x 150 | 5 | 29,00 | 28,00 |

Gwoździe SKOBLĘ do montażu siatki

U-nails





| INDEX | ROZMIAR SIZE [mm] | KOLOR COLOR | ILOŚĆ QUANTITY [kg] | | CENA / PRICE 1 kg [PLN] |
|----------|----------------------|----------------|------------------------|------|-------------------------------|
| | | | 1 kg | 1 kg | |
| SKO2525S | 2,5 x 25 | ocynk / zinc | 5 | 20 | 17,85 |
| SKO3030S | 3,0 x 30 | ocynk / zinc | 5 | 20 | 17,54 |
| SKO3035S | 3,0 x 35 | ocynk / zinc | 5 | 20 | 17,54 |
| SKO3540S | 3,5 x 40 | ocynk / zinc | 5 | 20 | 17,54 |

Wkręt samowiertny do mocowania blach do konstrukcji stalowej bez podkładki

Self drilling screws, hex washer head, hardened, zinc plated

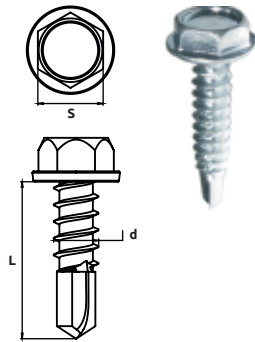
ETA-17/0781 DIN 7504 K 



| INDEX | ROZMIAR SIZE [mm] | | | MAKSYMALNA PRZEWIERCALNOŚĆ DRILLING CAPACITY [mm] | ILOŚĆ [szt.] QUANTITY [pcs] | | CENA / PRICE 1 000 szt. / pcs. [PLN] |
|------------|----------------------|-----|----|---|---|---|--|
| | d | L | s | |  |  | |
| OC42013 | 4,2 | 13 | 7 | 2,25 | 250 | 6000 | 75,14 |
| OC42016 | 4,2 | 16 | 7 | 2,25 | 250 | 6000 | 80,20 |
| OC42019 | 4,2 | 19 | 7 | 2,25 | 250 | 6000 | 86,74 |
| OC42025 | 4,2 | 25 | 7 | 2,25 | 250 | 6000 | 92,68 |
| OC42032 | 4,2 | 32 | 7 | 2,25 | 250 | 3000 | 114,26 |
| OC42038 | 4,2 | 38 | 7 | 2,25 | 250 | 3000 | 148,11 |
| OC48013 | 4,8 | 13 | 7 | 3,0 | 250 | 6000 | 100,55 |
| OC48016 | 4,8 | 16 | 8 | 3,0 | 250 | 6000 | 103,08 |
| OC48019 | 4,8 | 19 | 8 | 3,0 | 250 | 6000 | 108,14 |
| OC48022 | 4,8 | 22 | 8 | 3,0 | 250 | 6000 | 119,45 |
| OC48025 | 4,8 | 25 | 8 | 3,0 | 250 | 6000 | 124,06 |
| OC48032 | 4,8 | 32 | 8 | 3,0 | 250 | 3000 | 145,90 |
| OC48035 | 4,8 | 35 | 8 | 3,0 | 250 | 3000 | 149,92 |
| OC48038 | 4,8 | 38 | 8 | 3,0 | 250 | 3000 | 158,07 |
| OC48045 | 4,8 | 45 | 8 | 3,0 | 250 | 3000 | 182,21 |
| OC48055 | 4,8 | 55 | 8 | 3,0 | 250 | 3000 | 203,15 |
| OC55019 | 5,5 | 19 | 8 | 5,0 | 250 | 6000 | 137,87 |
| OC55022 | 5,5 | 22 | 8 | 5,0 | 250 | 3000 | 145,29 |
| OC55025 | 5,5 | 25 | 8 | 5,0 | 250 | 3000 | 157,81 |
| OC55032 | 5,5 | 32 | 8 | 5,0 | 250 | 3000 | 186,49 |
| OC55035 | 5,5 | 35 | 8 | 5,0 | 250 | 3000 | 197,50 |
| OC55038 | 5,5 | 38 | 8 | 5,0 | 250 | 3000 | 208,23 |
| OC55045 | 5,5 | 45 | 8 | 5,0 | 250 | 3000 | 231,27 |
| OC55050 | 5,5 | 50 | 8 | 5,0 | 250 | 3000 | 251,05 |
| OC55063 | 5,5 | 63 | 8 | 5,0 | 250 | 3000 | 283,15 |
| OC55075 | 5,5 | 75 | 8 | 5,0 | 200 | 2400 | 331,20 |
| OC55090 | 5,5 | 90 | 8 | 5,0 | 100 | 1200 | 459,55 |
| OC55120 | 5,5 | 120 | 8 | 5,0 | 100 | 1200 | 688,37 |
| OC63019 | 6,3 | 19 | 10 | 6,0 | 250 | 3000 | 204,89 |
| OC63025 | 6,3 | 25 | 10 | 6,0 | 250 | 3000 | 224,14 |
| OC63032 | 6,3 | 32 | 10 | 6,0 | 250 | 3000 | 265,61 |
| OC63038 | 6,3 | 38 | 10 | 6,0 | 250 | 3000 | 294,60 |
| OC63050 | 6,3 | 50 | 10 | 6,0 | 250 | 3000 | 359,27 |
| OC63063 | 6,3 | 63 | 10 | 6,0 | 200 | 2400 | 429,60 |
| OC63075 | 6,3 | 75 | 10 | 6,0 | 100 | 1200 | 500,69 |
| OC55024_8 | 5,5 | 24 | 8 | 8,0 | 250 | 3000 | 289,91 |
| OC55032_12 | 5,5 | 32 | 8 | 12,0 | 250 | 3000 | 310,92 |
| OC55035_12 | 5,5 | 35 | 8 | 12,0 | 250 | 3000 | 327,40 |
| OC55038_12 | 5,5 | 38 | 8 | 12,0 | 250 | 3000 | 350,48 |
| OC55050_12 | 5,5 | 50 | 8 | 12,0 | 250 | 3000 | 403,84 |
| OC55067_12 | 5,5 | 67 | 8 | 12,0 | 200 | 2400 | 529,32 |

* możliwość lakierowania w dowolnym kolorze wg palety RAL, koszt lakierowania 40 PLN/1000 sztuk

Blachowkręt samowiertny z gniazdem kwadratowym

Square pan head, self drilling screw, hardened, zinc plated

ITB-KOT-2022/0761 wyd.1 

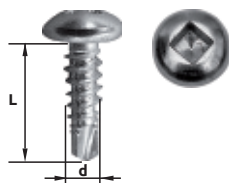

| INDEX | ROZMIAR SIZE [mm] d x L | GNAZDO DRIVE  | MAKSYMALNA PRZEWIERCALNOŚĆ DRILLING CAPACITY [mm] | ILOŚĆ [szt.] QUANTITY [pcs] | CENA / PRICE 1 000 szt. / pcs. [PLN] |
|----------|-------------------------------|--|---|--------------------------------|--|
| | | | | | |
| WMW-4216 | 4,2 x 16 | R2 | 3,0 | 1000 | 49,61 |
| WMW-4219 | 4,2 x 19 | R2 | 3,0 | 1000 | 52,87 |

Wkręt samowiertny do mocowania blach do konstrukcji stalowej, z podkładką EPDM

Self-drilling roofing screw with EPDM washer

ETA-17/0781 DIN 7504 K 

| INDEX | ROZMIAR SIZE [mm] | MAKSYMALNA PRZEWIERCALNOŚĆ DRILLING CAPACITY [mm] | ILOŚĆ [szt.] QUANTITY [pcs] | | CENA / PRICE 1 000 szt. / pcs. [PLN] |
|-----------|----------------------|---|--------------------------------|------|--|
| OCG-42016 | 4,2 x 16 | 2,25 | 250 | 3000 | 144,00 |
| OCG-42019 | 4,2 x 19 | 2,25 | 250 | 3000 | 147,00 |
| OCG-48016 | 4,8 x 16 | 3,0 | 250 | 3000 | 159,93 |
| OCG-48019 | 4,8 x 19 | 3,0 | 250 | 3000 | 165,00 |
| OCG-48022 | 4,8 x 22 | 3,0 | 250 | 3000 | 176,30 |
| OCG-48025 | 4,8 x 25 | 3,0 | 250 | 3000 | 180,92 |
| OCG-48032 | 4,8 x 32 | 3,0 | 250 | 3000 | 202,77 |
| OCG-48035 | 4,8 x 35 | 3,0 | 250 | 3000 | 206,80 |
| OCG-48038 | 4,8 x 38 | 3,0 | 250 | 3000 | 214,94 |
| OCG-48045 | 4,8 x 45 | 3,0 | 250 | 3000 | 239,08 |
| OCG-48055 | 4,8 x 55 | 3,0 | 250 | 3000 | 260,03 |
| OCG-55019 | 5,5 x 19 | 5,0 | 250 | 3000 | 206,54 |
| OCG-55022 | 5,5 x 22 | 5,0 | 250 | 3000 | 213,95 |
| OCG-55025 | 5,5 x 25 | 5,0 | 250 | 3000 | 226,49 |
| OCG-55032 | 5,5 x 32 | 5,0 | 250 | 3000 | 255,15 |
| OCG-55035 | 5,5 x 35 | 5,0 | 250 | 3000 | 266,18 |
| OCG-55038 | 5,5 x 38 | 5,0 | 250 | 3000 | 276,89 |
| OCG-55045 | 5,5 x 45 | 5,0 | 250 | 3000 | 299,93 |
| OCG-55050 | 5,5 x 50 | 5,0 | 250 | 3000 | 319,72 |
| OCG-55063 | 5,5 x 63 | 5,0 | 200 | 2400 | 351,83 |
| OCG-55075 | 5,5 x 75 | 5,0 | 100 | 1200 | 433,46 |
| OCG-55090 | 5,5 x 90 | 5,0 | 100 | 1200 | 561,78 |
| OCG-55120 | 5,5 x 120 | 5,0 | 50 | 600 | 837,14 |
| OCG-63019 | 6,3 x 19 | 6,0 | 250 | 3000 | 334,69 |
| OCG-63025 | 6,3 x 25 | 6,0 | 250 | 3000 | 353,92 |
| OCG-63032 | 6,3 x 32 | 6,0 | 250 | 3000 | 395,41 |
| OCG-63038 | 6,3 x 38 | 6,0 | 250 | 2400 | 424,38 |
| OCG-63050 | 6,3 x 50 | 6,0 | 100 | 1200 | 489,06 |
| OCG-63063 | 6,3 x 63 | 6,0 | 100 | 1200 | 559,38 |
| OCG-63075 | 6,3 x 75 | 6,0 | 50 | 600 | 630,49 |

* możliwość lakierowania w dowolnym kolorze wg palety RAL, koszt lakierowania 40 PLN/1000 sztuk

Wkręt samowiertny do mocowania blach do konstrukcji stalowej, z podkładką EPDM

Self-drilling roofing inch screw with EPDM washer

ETA-17/0781 DIN 7504 K 

| INDEX | ROZMIAR SIZE [mm] | MAKSYMALNA PRZEWIERCALNOŚĆ DRILLING CAPACITY [mm] | ILOŚĆ [szt.] QUANTITY [pcs] | | CENA / PRICE 1 000 szt. / pcs. [PLN] |
|--------------|----------------------|---|--------------------------------|------|--|
| OCG-55024_8 | 5,5 x 24 | 8,0 | 250 | 3000 | 358,57 |
| OCG-55032_12 | 5,5 x 32 | 12,0 | 250 | 3000 | 378,76 |
| OCG-55035_12 | 5,5 x 35 | 12,0 | 250 | 3000 | 396,07 |
| OCG-55038_12 | 5,5 x 38 | 12,0 | 250 | 3000 | 419,15 |
| OCG-55050_12 | 5,5 x 50 | 12,0 | 250 | 3000 | 472,52 |
| OCG-55067_12 | 5,5 x 67 | 12,0 | 100 | 1200 | 631,56 |

* możliwość lakierowania w dowolnym kolorze wg palety RAL, koszt lakierowania 40 PLN/1000 sztuk

Wkręt samowiertny do mocowania płyt warstwowych do konstrukcji stalowych, maksymalna przewiercalność 6 mm z podkładką EPDM

Self-drilling roofing distance inch screw with EPDM washer



| INDEX | ROZMIAR SIZE [mm] | MAKSYMALNA PRZEWIERCALNOŚĆ DRILLING CAPACITY [mm] | ILOŚĆ [szt.] QUANTITY [pcs] | | CENA / PRICE 1 000 szt. / pcs. [PLN] |
|-----------|----------------------|---|--------------------------------|--|--|
| OWG-06065 | 5,5 x 65 | 6 | 50 | | 548,00 |
| OWG-06090 | 5,5 x 90 | 6 | 50 | | 628,00 |
| OWG-06110 | 5,5 x 110 | 6 | 50 | | 763,00 |
| OWG-06125 | 5,5 x 125 | 6 | 50 | | 963,81 |
| OWG-06150 | 5,5 x 150 | 6 | 50 | | 1 256,27 |
| OWG-06175 | 5,5 x 175 | 6 | 50 | | 1 768,27 |
| OWG-06200 | 5,5 x 200 | 6 | 50 | | 2 154,21 |
| OWG-06230 | 5,5 x 230 | 6 | 50 | | 3 218,92 |
| OWG-06285 | 5,5 x 285 | 6 | 50 | | 5 760,00 |

Wkręt samowiertny do mocowania płyt warstwowych do konstrukcji stalowych, maksymalna przewiercalność 12 mm z podkładką EPDM

Self-drilling roofing distance inch screw with EPDM washer



| INDEX | ROZMIAR SIZE [mm] | MAKSYMALNA PRZEWIERCALNOŚĆ DRILLING CAPACITY [mm] | ILOŚĆ [szt.] QUANTITY [pcs] | CENA / PRICE 1 000 szt. / pcs. [PLN] |
|-----------|-------------------|---|-----------------------------|--------------------------------------|
| OWG-12070 | 5,5 x 70 | 12 | 50 | 663,23 |
| OWG-12090 | 5,5 x 90 | 12 | 50 | 821,26 |
| OWG-12110 | 5,5 x 110 | 12 | 50 | 982,55 |
| OWG-12130 | 5,5 x 130 | 12 | 50 | 1 219,20 |
| OWG-12150 | 5,5 x 150 | 12 | 50 | 1 566,28 |
| OWG-12175 | 5,5 x 175 | 12 | 50 | 1 989,97 |
| OWG-12185 | 5,5 x 185 | 12 | 50 | 2 207,35 |
| OWG-12200 | 5,5 x 200 | 12 | 50 | 2 640,40 |
| OWG-12230 | 5,5 x 230 | 12 | 50 | 3 479,90 |
| OWG-12285 | 5,5 x 285 | 12 | 50 | 5 086,70 |

Wkręt do mocowania płyt warstwowych do konstrukcji betonowych z podkładką EPDM

Self-drilling roofing distance inch screw with EPDM washer



| INDEX | ROZMIAR SIZE [mm] | ILOŚĆ [szt.] QUANTITY [pcs] | CENA / PRICE 1 000 szt. / pcs. [PLN] |
|-----------|-------------------|-----------------------------|--------------------------------------|
| OWB-64100 | 6,4 x 100 | 100 | 1 859,70 |
| OWB-64120 | 6,4 x 120 | 100 | 1 952,70 |
| OWB-64140 | 6,4 x 140 | 100 | 2 045,70 |
| OWB-64160 | 6,4 x 160 | 100 | 2 417,60 |
| OWB-64190 | 6,4 x 190 | 100 | 3 839,80 |
| OWB-64210 | 6,4 x 210 | 100 | 4 388,90 |
| OWB-64240 | 6,4 x 240 | 100 | 5 811,90 |
| OWB-64260 | 6,4 x 260 | 100 | 6 694,90 |
| OWB-64280 | 6,4 x 280 | 100 | 7 588,80 |
| OWB-64310 | 6,4 x 310 | 100 | 10 096,00 |

Podkładka EPDM

EPDM Washer

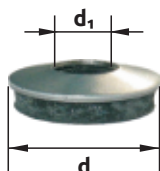

| INDEX | ŚREDNICA DIAMETER [mm] d | ŚREDNICA WKRETA SCREW DIAMETER [mm] d ₁ | ILOŚĆ [szt.] QUANTITY [pcs] | CENA / PRICE 1 000 szt. / pcs. [PLN] |
|---------|--------------------------|--|-----------------------------|--------------------------------------|
| EPDM-12 | 12 | 4,2 | 1000 | 47,00 |
| EPDM-14 | 14 | 4,8 | 1000 | 53,23 |
| EPDM-16 | 16 | 5,5 | 1000 | 66,15 |
| EPDM-19 | 19 | 6,3 | 500 | 96,46 |
| EPDM-25 | 25 | 8,0 | 250 | 166,15 |

Wkręt samowiertny do stolarki PCV

Windows buliding self-drilling screws



| INDEX | ROZMIAR SIZE [mm] | GNIAZDO DRIVE | ILOŚĆ [szt.] QUANTITY [pcs] | CENA / PRICE 1000 szt./pcs [PLN] |
|---------|-------------------|---------------|-----------------------------|----------------------------------|
| KS-3913 | 3,9 x 13 | PH-2 | 1000 | 26,90 |
| KS-3916 | 3,9 x 16 | PH-2 | 1000 | 35,90 |
| KS-3919 | 3,9 x 19 | PH-2 | 1000 | 40,80 |
| KS-3925 | 3,9 x 25 | PH-2 | 1000 | 52,80 |
| KS-3932 | 3,9 x 32 | PH-2 | 1000 | 65,90 |
| KS-3938 | 3,9 x 38 | PH-2 | 1000 | 76,20 |

Wkręt do montażu oku z łbem stożkowym

Windows buliding self-taping screws



| INDEX | ROZMIAR SIZE [mm] | GNIAZDO DRIVE | ILOŚĆ [szt.] QUANTITY [pcs] | CENA / PRICE 1000 szt./pcs [PLN] |
|----------|-------------------|---------------|-----------------------------|----------------------------------|
| KSO-4020 | 4,0 x 20 | PH-2 | 1000 | 32,30 |
| KSO-4025 | 4,0 x 25 | PH-2 | 1000 | 42,80 |
| KSO-4030 | 4,0 x 30 | PH-2 | 500 | 48,70 |
| KSO-4035 | 4,0 x 35 | PH-2 | 500 | 56,40 |
| KSO-4040 | 4,0 x 40 | PH-2 | 500 | 63,80 |

Wkręt montażowy do cienkich blach, tworzyw sztucznych i drewna z tępym podkładkowym *

Wafer head phillips, sharp point screw hardened, zinc plated

ITB-KOT-2022/0761 wyd. 1



| INDEX | ROZMIAR SIZE [mm] | ILOŚĆ [szt.] QUANTITY [pcs] | | CENA / PRICE | |
|---------|----------------------|--------------------------------|------|--------------|------------------------|
| | | | | 1kg [PLN] | 1000 szt./pcs [PLN] |
| WM-4213 | 4,2 x 13 | 250 | 6000 | 30,31 | 51,71 |
| WM-4216 | 4,2 x 16 | 250 | 6000 | 30,31 | 59,89 |
| WM-4219 | 4,2 x 19 | 250 | 6000 | 30,31 | 63,72 |
| WM-4225 | 4,2 x 25 | 250 | 6000 | 30,31 | 77,09 |
| WM-4230 | 4,2 x 30 | 250 | 6000 | 30,31 | 80,97 |
| WM-4238 | 4,2 x 38 | 250 | 6000 | 30,31 | 113,01 |
| WM-4250 | 4,2 x 50 | 250 | 3000 | 30,31 | 121,78 |
| WM-4265 | 4,2 x 65 | 250 | 3000 | 30,31 | 150,38 |

Wkręt montażowy do cienkich blach, tworzyw sztucznych i drewna z tępym podkładkowym - fosfatowany *

Wafer head phillips, sharp point screw hardened, phosphated

ITB-KOT-2022/0761 wyd. 1



| INDEX | ROZMIAR SIZE [mm] | ILOŚĆ [szt.] QUANTITY [pcs] | | CENA / PRICE | |
|----------|----------------------|--------------------------------|------|--------------|------------------------|
| | | | | 1kg [PLN] | 1000 szt./pcs [PLN] |
| WMF-4213 | 4,2 x 13 | 250 | 6000 | 30,31 | 51,71 |
| WMF-4216 | 4,2 x 16 | 250 | 6000 | 30,31 | 59,89 |
| WMF-4219 | 4,2 x 19 | 250 | 6000 | 30,31 | 63,72 |
| WMF-4225 | 4,2 x 25 | 250 | 6000 | 30,31 | 77,09 |
| WMF-4230 | 4,2 x 30 | 250 | 6000 | 30,31 | 80,97 |
| WMF-4238 | 4,2 x 38 | 250 | 6000 | 30,31 | 113,00 |
| WMF-4250 | 4,2 x 50 | 250 | 3000 | 30,31 | 121,78 |
| WMF-4265 | 4,2 x 65 | 250 | 3000 | 30,31 | 158,30 |

Wkręt montażowy samowiercący uniwersalny, przewiercalność max. 2,25 mm *

Wafer head phillips, self-drilling screw hardened, zinc plated

ITB-KOT-2022/0761 wyd. 1



| INDEX | ROZMIAR SIZE [mm] | ILOŚĆ [szt.] QUANTITY [pcs] | | CENA / PRICE | |
|----------|----------------------|--------------------------------|------|--------------|------------------------|
| | | | | 1kg [PLN] | 1000 szt./pcs [PLN] |
| WMS-4213 | 4,2 x 13 | 250 | 6000 | 31,38 | 57,62 |
| WMS-4216 | 4,2 x 16 | 250 | 6000 | 31,38 | 63,54 |
| WMS-4219 | 4,2 x 19 | 250 | 6000 | 31,38 | 70,77 |
| WMS-4225 | 4,2 x 25 | 250 | 6000 | 31,38 | 85,67 |
| WMS-4232 | 4,2 x 32 | 250 | 6000 | 31,38 | 110,09 |
| WMS-4240 | 4,2 x 40 | 250 | 6000 | 31,38 | 131,73 |
| WMS-4250 | 4,2 x 50 | 250 | 3000 | 31,38 | 153,38 |
| WMS-4265 | 4,2 x 65 | 250 | 3000 | 31,38 | 186,88 |

Wkręt montażowy samowiercący uniwersalny fosfatowany, przewier. max. 2,25 mm *

Wafer head phillips, self-drilling screw hardened, phosphated

ITB-KOT-2022/0761 wyd. 1



| INDEX | ROZMIAR SIZE [mm] | ILOŚĆ [szt.] QUANTITY [pcs] | | CENA / PRICE | |
|-----------|----------------------|--------------------------------|------|--------------|------------------------|
| | | | | 1kg [PLN] | 1000 szt./pcs [PLN] |
| WMSF-4213 | 4,2 x 13 | 250 | 6000 | 31,38 | 57,62 |
| WMSF-4216 | 4,2 x 16 | 250 | 6000 | 31,38 | 63,54 |
| WMSF-4219 | 4,2 x 19 | 250 | 6000 | 31,38 | 70,77 |
| WMSF-4225 | 4,2 x 25 | 250 | 6000 | 31,38 | 85,67 |
| WMSF-4232 | 4,2 x 32 | 250 | 6000 | 31,38 | 110,09 |
| WMSF-4240 | 4,2 x 40 | 250 | 6000 | 31,38 | 131,73 |
| WMSF-4250 | 4,2 x 50 | 250 | 3000 | 31,38 | 153,38 |
| WMSF-4265 | 4,2 x 65 | 250 | 3000 | 31,38 | 186,88 |

* - możliwość lakierowania w dowolnym kolorze według palety RAL
- koszt lakierowania 30 PLN / 1000 sztuk

Błachowkręt samowiertny z łbem walcowym PH

Pan head sheet metal screw

ITB-KOT-2022/0761 wyd.1

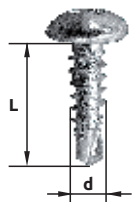

| INDEX | ROZMIAR SIZE [mm] d x L | GNIAZDO DRIVE + | MAKSYMALNA PRZEWIERCALNOŚĆ DRILLING CAPACITY [mm] | ILOŚĆ [szt.] QUANTITY [pcs] | CENA / PRICE 1 000 szt. / pcs. [PLN] |
|----------|----------------------------|--------------------|--|--------------------------------|--|
| OCS-3911 | 3,9 x 11 | PH2 | 2,25 | 1000 | 41,12 |
| OCS-3913 | 3,9 x 13 | PH2 | 2,25 | 1000 | 45,69 |
| OCS-3916 | 3,9 x 16 | PH2 | 2,25 | 1000 | 49,84 |
| OCS-3919 | 3,9 x 19 | PH2 | 2,25 | 1000 | 54,00 |
| OCS-3925 | 3,9 x 25 | PH2 | 2,25 | 1000 | 63,00 |
| OCS-3932 | 3,9 x 32 | PH2 | 2,25 | 1000 | 74,77 |
| OCS-4213 | 4,2 x 13 | PH2 | 3,0 | 1000 | 49,85 |
| OCS-4216 | 4,2 x 16 | PH2 | 3,0 | 1000 | 55,38 |
| OCS-4219 | 4,2 x 19 | PH2 | 3,0 | 1000 | 60,23 |
| OCS-4225 | 4,2 x 25 | PH2 | 3,0 | 1000 | 69,92 |
| OCS-4232 | 4,2 x 32 | PH2 | 3,0 | 1000 | 83,07 |
| OCS-4238 | 4,2 x 38 | PH2 | 3,0 | 1000 | 99,00 |
| OCS-4813 | 4,8 x 13 | PH2 | 4,0 | 500 | 67,85 |
| OCS-4816 | 4,8 x 16 | PH2 | 4,0 | 500 | 73,38 |
| OCS-4819 | 4,8 x 19 | PH2 | 4,0 | 500 | 80,31 |
| OCS-4825 | 4,8 x 25 | PH2 | 4,0 | 500 | 94,15 |
| OCS-4832 | 4,8 x 32 | PH2 | 4,0 | 500 | 110,77 |
| OCS-4838 | 4,8 x 38 | PH2 | 4,0 | 500 | 121,85 |

Wkręt do cienkich blach z łbem stożkowym, ze skrzydełkami

Self drilling screws with wings

ITB-KOT-2022/0761 wyd. 1



| INDEX | ROZMIAR SIZE [mm] | GNIAZDO DRIVE + | MAKSYMALNA PRZEWIERCALNOŚĆ DRILLING CAPACITY [mm] | ILOŚĆ [szt.] QUANTITY [pcs] | CENA / PRICE 1000 szt./pcs [PLN] |
|----------|-------------------|--------------------|--|--------------------------------|--|
| KSS-4832 | 4,8 x 32 | TX-25 | 2,5 | 500 | 103,80 |
| KSS-4838 | 4,8 x 38 | TX-25 | 2,5 | 500 | 120,00 |
| KSS-4845 | 4,8 x 45 | TX-25 | 2,5 | 500 | 142,80 |
| KSS-4855 | 4,8 x 55 | TX-25 | 2,5 | 500 | 166,90 |
| KSS-5538 | 5,5 x 38 | TX-25 | 4,5 | 250 | 160,50 |
| KSS-5545 | 5,5 x 45 | TX-25 | 4,5 | 250 | 183,10 |
| KSS-5550 | 5,5 x 50 | TX-25 | 4,5 | 250 | 200,80 |
| KSS-5555 | 5,5 x 55 | TX-25 | 4,5 | 250 | 218,00 |
| KSS-5570 | 5,5 x 70 | TX-25 | 4,5 | 200 | 272,80 |
| KSS-6350 | 6,3 x 50 | TX-30 | 6,0 | 200 | 270,50 |
| KSS-6360 | 6,3 x 60 | TX-30 | 6,0 | 200 | 317,40 |
| KSS-6370 | 6,3 x 70 | TX-30 | 6,0 | 200 | 364,40 |

Tuleja 45 z polipropylenu do mocowania pokryć dachowych, okrągła
 Telescopic sleeve with round plate

UWAGA!
Długość robocza kolka teleskopowego jest o 15mm krótsza od długości całkowitej.

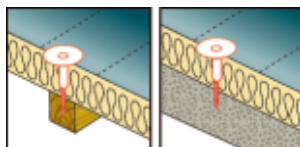

| INDEX | DŁUGOŚĆ LENGTH [mm] | ILOŚĆ [szt.] QUANTITY [pcs] | CENA / PRICE 1000 szt./pcs [PLN] |
|---------|---------------------|-----------------------------|----------------------------------|
| GOK-035 | 35 | 500 | 664,60 |
| GOK-065 | 65 | 500 | 762,08 |
| GOK-085 | 85 | 500 | 767,74 |
| GOK-105 | 105 | 500 | 833,90 |
| GOK-135 | 135 | 500 | 909,72 |
| GOK-165 | 165 | 500 | 998,92 |
| GOK-185 | 185 | 500 | 1 057,44 |
| GOK-225 | 225 | 500 | 1 621,42 |
| GOK-235 | 235 | 500 | 1 861,60 |
| GOK-255 | 255 | 500 | 1 926,88 |
| GOK-285 | 285 | 500 | 2 032,56 |

DOBÓR ŁĄCZNIKÓW / SELECTION OF THE CONNECTOR

| PODŁOŻE STALOWE / STEEL SUBSTRATE GOK + EDSB | | | PODŁOŻE BETONOWE / CONCRETE SUBSTRATE GOK + EDSS + KKW08L60 | | | PODŁOŻE BETONOWE / CONCRETE SUBSTRATE GOK + GTHD | | |
|---|----------------------------|------------------------------|--|----------------------------|------------------------------|---|----------------------------|------------------------------|
| GR. IZOLACJI INSULATION THICKNESS [mm] | DŁ. TULEI PLUG LENGTH [mm] | DŁ. WKRETA SCREW LENGTH [mm] | GR. IZOLACJI INSULATION THICKNESS [mm] | DŁ. TULEI PLUG LENGTH [mm] | DŁ. WKRETA SCREW LENGTH [mm] | GR. IZOLACJI INSULATION THICKNESS [mm] | DŁ. TULEI PLUG LENGTH [mm] | DŁ. WKRETA SCREW LENGTH [mm] |
| 30 | 15 | 50 | 30 | 15 | 90 | | | |
| 40 | 15 | 60 | 40 | 15 | 100 | | | |
| 50 | 35 | 50 | 50 | 35 | 90 | 50 | 35 | 60 |
| 60 | 35 | 60 | 60 | 35 | 100 | 60 | 35 | 70 |
| 70 | 35 | 70 | 70 | 35 | 110 | 70 | 35 | 80 |
| 80 | 65 | 50 | 80 | 65 | 90 | 80 | 65 | 60 |
| 90 | 65 | 60 | 90 | 65 | 100 | 90 | 65 | 70 |
| 100 | 85 | 50 | 100 | 85 | 90 | 100 | 85 | 60 |
| 110 | 85 | 60 | 110 | 85 | 100 | 110 | 85 | 70 |
| 120 | 105 | 50 | 120 | 105 | 90 | 120 | 105 | 60 |
| 130 | 105 | 60 | 130 | 105 | 100 | 130 | 105 | 70 |
| 140 | 105 | 70 | 140 | 105 | 110 | 140 | 105 | 80 |
| 150 | 135 | 50 | 150 | 135 | 90 | 150 | 135 | 60 |
| 160 | 135 | 60 | 160 | 135 | 100 | 160 | 135 | 70 |
| 170 | 135 | 70 | 170 | 135 | 110 | 170 | 165 | 80 |
| 180 | 165 | 50 | 180 | 165 | 90 | 180 | 165 | 60 |
| 190 | 165 | 60 | 190 | 165 | 100 | 190 | 165 | 70 |
| 200 | 185 | 50 | 200 | 185 | 90 | 200 | 185 | 60 |
| 210 | 185 | 60 | 210 | 185 | 100 | 210 | 185 | 70 |
| 220 | 185 | 70 | 220 | 185 | 110 | 220 | 185 | 80 |
| 230 | 185 | 80 | 230 | 185 | 120 | 230 | 185 | 90 |
| 240 | 185 | 90 | 240 | 185 | 130 | 240 | 185 | 100 |
| 250 | 225 | 60 | 250 | 225 | 100 | 250 | 235 | 60 |
| 260 | 225 | 70 | 260 | 225 | 110 | 260 | 235 | 70 |
| 270 | 225 | 80 | 270 | 225 | 120 | 270 | 235 | 80 |
| 280 | 255 | 60 | 280 | 255 | 100 | 280 | 235 | 90 |
| 300 | 255 | 80 | 300 | 255 | 120 | 300 | 285 | 60 |
| 320 | 255 | 100 | 320 | 255 | 140 | 320 | 285 | 80 |
| 340 | 285 | 90 | 340 | 285 | 130 | 340 | 285 | 100 |
| 360 | 285 | 110 | 360 | 285 | 150 | 360 | 335 | 70 |
| 380 | 285 | 130 | 380 | 285 | 170 | 380 | 335 | 90 |

Wkręt do blach odporny na korozję, 15 cykli Kesternicha przewiercalność max. 1,25 mm
 Self-drilling flat head window screw for steel assembly

| INDEX | ROZMIAR SIZE [mm] | ILOŚĆ [szt.] QUANTITY [pcs] | CENA / PRICE 1000 szt./pcs [PLN] |
|------------|-------------------|-----------------------------|----------------------------------|
| EDSB-48050 | 4,8 x 50 | 500 | 358,56 |
| EDSB-48060 | 4,8 x 60 | 500 | 474,64 |
| EDSB-48070 | 4,8 x 70 | 500 | 529,30 |
| EDSB-48080 | 4,8 x 80 | 500 | 727,26 |
| EDSB-48090 | 4,8 x 90 | 500 | 829,82 |
| EDSB-48100 | 4,8 x 100 | 500 | 939,36 |
| EDSB-48110 | 4,8 x 110 | 500 | 1 086,28 |
| EDSB-48120 | 4,8 x 120 | 500 | 1 198,08 |
| EDSB-48130 | 4,8 x 130 | 500 | 1 547,72 |
| EDSB-48140 | 4,8 x 140 | 500 | 1 766,86 |
| EDSB-48150 | 4,8 x 150 | 500 | 2 221,36 |

Wkręty do blach odporne na korozję, 15 cykli Kesternicha przewiercalność max. 0,9 mm

Self-drilling flat head window screw for steel assembly



| INDEX | ROZMIAR SIZE [mm] | ILOŚĆ [szt.] QUANTITY [pcs] | CENA / PRICE 1000 szt./pcs [PLN] |
|------------|----------------------|--------------------------------|--|
| EDSS-48050 | 4,8 x 50 | 1000 | 307,65 |
| EDSS-48060 | 4,8 x 60 | 500 | 367,80 |
| EDSS-48070 | 4,8 x 70 | 500 | 420,36 |
| EDSS-48080 | 4,8 x 80 | 500 | 529,28 |
| EDSS-48090 | 4,8 x 90 | 500 | 546,23 |
| EDSS-48100 | 4,8 x 100 | 500 | 752,78 |
| EDSS-48110 | 4,8 x 110 | 500 | 799,64 |
| EDSS-48120 | 4,8 x 120 | 500 | 973,86 |
| EDSS-48130 | 4,8 x 130 | 500 | 1 000,28 |
| EDSS-48140 | 4,8 x 140 | 500 | 1 074,54 |
| EDSS-48150 | 4,8 x 150 | 500 | 1 232,60 |
| EDSS-48160 | 4,8 x 160 | 500 | 1 534,18 |
| EDSS-48180 | 4,8 x 180 | 500 | 2 365,42 |
| EDSS-48200 | 4,8 x 200 | 500 | 3 146,74 |
| EDSS-48220 | 4,8 x 220 | 500 | 4 673,80 |
| EDSS-48240 | 4,8 x 240 | 500 | 6 632,30 |
| EDSS-48260 | 4,8 x 260 | 500 | 9 176,66 |

Łącznik izolacyjny do betonu, TORX 25

Insulation screws for concrete construction

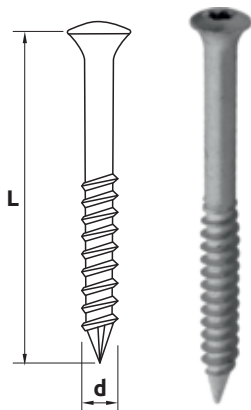

| INDEX | ROZMIAR SIZE [mm] | ILOŚĆ [szt.] QUANTITY [pcs] | CENA / PRICE 1000 szt./pcs [PLN] |
|------------|----------------------|--------------------------------|--|
| GTHD-63060 | 6,3 x 60 | 500 | 644,48 |
| GTHD-63070 | 6,3 x 70 | 500 | 743,78 |
| GTHD-63080 | 6,3 x 80 | 500 | 843,34 |
| GTHD-63090 | 6,3 x 90 | 500 | 991,10 |
| GTHD-63100 | 6,3 x 100 | 500 | 1 094,30 |
| GTHD-63130 | 6,3 x 130 | 500 | 1 544,84 |
| GTHD-63160 | 6,3 x 160 | 500 | 2 304,10 |
| GTHD-63180 | 6,3 x 180 | 500 | 3 158,88 |
| GTHD-63200 | 6,3 x 200 | 500 | 3 875,02 |
| GTHD-63220 | 6,3 x 220 | 500 | 4 857,82 |
| GTHD-63250 | 6,3 x 250 | 500 | 6 019,34 |
| GTHD-63280 | 6,3 x 280 | 500 | 8 544,20 |
| GTHD-63300 | 6,3 x 300 | 500 | 8 684,12 |

Łącznik do dachów betonowych

Plug for concrete roofs



| INDEX | ROZMIAR SIZE [mm] | ILOŚĆ [szt.] QUANTITY [pcs] | CENA / PRICE 1000 szt./pcs [PLN] |
|-----------|----------------------|--------------------------------|--|
| KKW-08L60 | 8 x 60 | 200 2400 | 60,00 |

Wkręt farmerski do mocowania profilowanych blach stalowych do konstrukcji drewnianych, z podkładką EPDM

Self-drilling farmer screw with EPDM washer

ETA-17/0781



| INDEX | ROZMIAR SIZE [mm] | KOLOR COLOR | ILOŚĆ [szt.] QUANTITY [pcs] | CENA / PRICE 1 opak. / 1 box [PLN] |
|-----------|----------------------|----------------|--------------------------------|--|
| ODI20 | 4,8 x 20 | ocynk / zinc | 250 | 33,69 |
| ODI20 RAL | 4,8 x 20 | RAL | 250 | 35,23 |
| ODI35 | 4,8 x 35 | ocynk / zinc | 250 | 33,69 |
| ODI35 RAL | 4,8 x 35 | RAL | 250 | 35,23 |
| ODI50 | 4,8 x 50 | ocynk / zinc | 100 | 23,69 |
| ODI50 RAL | 4,8 x 50 | RAL | 100 | 25,07 |
| ODI60 | 4,8 x 60 | ocynk / zinc | 100 | 28,77 |
| ODI60 RAL | 4,8 x 60 | RAL | 100 | 30,00 |
| ODI70 | 4,8 x 70 | ocynk / zinc | 100 | 31,85 |
| ODI70 RAL | 4,8 x 70 | RAL | 100 | 33,38 |
| ODI80 | 4,8 x 80 | ocynk / zinc | 100 | 36,00 |
| ODI80 RAL | 4,8 x 80 | RAL | 100 | 37,54 |
| ODI99 | 4,8 x 100 | ocynk / zinc | 100 | 46,15 |
| ODI99 RAL | 4,8 x 100 | RAL | 100 | 47,69 |

DOSTĘPNE KOLORY
COLOURS AVAILABLE:

RAL 3005, RAL 3009, RAL 3011,
RAL 5010, RAL 6020, RAL 7024,
RAL 8004, RAL 8017, RAL 8019,
RAL 9005, RAL 9006, RAL 9010

Wkręt farmerski ETANCO OFA - do mocowania profilowanych blach stalowych do konstrukcji drewnianych, z podkładką stalową S-14 z podkładką EPDM

Self-drilling farmer screw with EPDM washer

ETA-12/0580 KOT-20018/0680 wyd. 3



DOSTĘPNE KOLORY COLOURS AVAILABLE:

RAL 3005, RAL 3009, RAL 3011,
RAL 5010, RAL 6020, RAL 7024,
RAL 8004, RAL 8017, RAL 8019,
RAL 9005, RAL 9006, RAL 9010

| INDEX | ROZMIAR SIZE [mm] | KOLOR COLOR | ILOŚĆ [szt.] QUANTITY [pcs] | CENA / PRICE 1 opak. / 1 box [PLN] |
|-------------|----------------------|----------------|--------------------------------|--|
| OD-20OC | 4,8 x 20 | ocynk / zinc | 250 | 45,84 |
| OD-20OC RAL | 4,8 x 20 | RAL | 250 | 47,38 |
| OD-35OC | 4,8 x 35 | ocynk / zinc | 250 | 45,85 |
| OD-35OC RAL | 4,8 x 35 | RAL | 250 | 47,38 |
| OD-50OC | 4,8 x 50 | ocynk / zinc | 100 | 33,38 |
| OD-50OC RAL | 4,8 x 50 | RAL | 100 | 35,23 |
| OD-60OC | 4,8 x 60 | ocynk / zinc | 100 | 39,95 |
| OD-60OC RAL | 4,8 x 60 | RAL | 100 | 42,00 |
| OD-70OC | 4,8 x 70 | ocynk / zinc | 100 | 45,23 |
| OD-70OC RAL | 4,8 x 70 | RAL | 100 | 47,08 |
| OD-80OC | 4,8 x 80 | ocynk / zinc | 100 | 65,25 |
| OD-80OC RAL | 4,8 x 80 | RAL | 100 | 69,98 |
| OD-99OC | 4,8 x 100 | ocynk / zinc | 100 | 71,00 |
| OD-99OC RAL | 4,8 x 100 | RAL | 100 | 75,00 |

Wkręt farmerski ETANCO typu PAN HEAD - do mocowania profilowanych blach stalowych do konstrukcji drewnianych, z podkładką aluminiową EPDM

Panhead farmer screw (for sheet metal and wood)



| INDEX | ROZMIAR SIZE [mm] | KOLOR COLOR | ILOŚĆ [szt.] QUANTITY [pcs] | CENA / PRICE 1 opak. / 1 box [PLN] |
|------------|----------------------|----------------|--------------------------------|--|
| FTX-20 OC | 4,8 x 20 | ocynk / zinc | 250 | 81,50 |
| FTX-20 RAL | 4,8 x 20 | RAL | 250 | 81,50 |
| FTX-35 OC | 4,8 x 35 | ocynk / zinc | 250 | 90,00 |
| FTX-35 RAL | 4,8 x 35 | RAL | 250 | 90,00 |

Kotłnierz uszczelniający Sealing collar



Kotłnierz wykonany z EPDM wzmocnionego taśmą aluminiową. Przeznaczony do uszczelnienia przelotów różnego rodzaju instalacji budynku (jak kominy, wentylacje, rury itp.) w elewacjach oraz dachach wykonanych z blach profilowanych.

| INDEX | RODZAJ TYPE | ŚREDNICA OTWORU HOLE DIAMETER [mm] | CENA / PRICE 1 szt. / 1 pcs [PLN] |
|-------|----------------|---------------------------------------|---|
| MF-1 | EPDM 1 | 6 - 50 | 48,61 |
| MF-2 | EPDM 2 | 32 - 76 | 62,13 |
| MF-3 | EPDM 3 | 60 - 102 | 68,26 |
| MF-4 | EPDM 4 | 76 - 152 | 110,74 |
| MF-5 | EPDM 5 | 102 - 178 | 129,67 |
| MF-6 | EPDM 6 | 127 - 228 | 138,50 |
| MF-7 | EPDM 7 | 152 - 280 | 178,11 |
| MF-8 | EPDM 8 | 178 - 330 | 214,13 |
| MF-9 | EPDM 9 | 254 - 467 | 742,80 |

Farba zaprawkowa Spray primers



| INDEX | RAL | KOLOR COLOR | CENA / PRICE 400 ml [PLN] |
|---------|------|----------------------------|---------------------------------|
| FA-1002 | 1002 | Jasny żółty / Light yellow | 44,00 |
| FA-1015 | 1015 | Kość słoniowa / Ivory | 44,00 |
| FA-1032 | 1032 | Żółty / Yellow | 44,00 |
| FA-3005 | 3005 | Wiśniowy / Cherry | 44,00 |
| FA-3009 | 3009 | Ciemny czerwony / Dark red | 44,00 |
| FA-3011 | 3011 | Czerwony / Red | 44,00 |
| FA-3016 | 3016 | Czerwony / Red | 44,00 |
| FA-5010 | 5010 | Niebieski / Blue | 44,00 |
| FA-6020 | 6020 | Zielony / Green | 44,00 |
| FA-6029 | 6029 | Zielony / Green | 44,00 |
| FA-7024 | 7024 | Ciemny szary / Dark grey | 44,00 |
| FA-7032 | 7032 | Jasny szary / Light grey | 44,00 |
| FA-8004 | 8004 | Ceglasty / Brick red | 44,00 |
| FA-8011 | 8011 | Brązowy / Brown | 44,00 |
| FA-8014 | 8014 | Brązowy / Brown | 44,00 |
| FA-8017 | 8017 | Brązowy / Brown | 44,00 |
| FA-9005 | 9005 | Czarny / Black | 44,00 |
| FA-9006 | 9006 | Srebrny / Silver | 44,00 |
| FA-9010 | 9010 | Biały / White | 44,00 |

Nit zrywalny Al / Fe

Open type blind rivet with dome head - white zinc Al/Fe



* - możliwość lakierowania
w dowolnym kolorze wg palety RAL
- koszt lakierowania 30 PLN / 1000 sztuk

| INDEX | ROZMIAR / SIZE d x L [mm] | ILOŚĆ [szt./kg] QUANTITY [psc/kg] | ILOŚĆ [kg] QUANTITY [kg] | CENA / PRICE 1 kg [PLN] |
|---------|---------------------------------|--------------------------------------|-----------------------------|-------------------------------|
| NIT-306 | 3 x 6 | 1152 | 10 | 29,08 |
| NIT-308 | 3 x 8 | 1148 | 10 | 29,08 |
| NIT-310 | 3 x 10 | 1000 | 10 | 29,08 |
| NIT-312 | 3 x 12 | 964 | 10 | 29,08 |
| NIT-406 | 4 x 6 | 624 | 10 | 24,46 |
| NIT-408 | 4 x 8 | 618 | 10 | 24,46 |
| NIT-410 | 4 x 10 | 602 | 10 | 24,46 |
| NIT-412 | 4 x 12 | 552 | 10 | 24,46 |
| NIT-414 | 4 x 14 | 521 | 10 | 24,46 |
| NIT-416 | 4 x 16 | 506 | 10 | 25,23 |
| NIT-418 | 4 x 18 | 500 | 10 | 25,23 |
| NIT-420 | 4 x 20 | 452 | 10 | 25,23 |
| NIT-506 | 5 x 6 | 401 | 10 | 24,46 |
| NIT-508 | 5 x 8 | 380 | 10 | 24,46 |
| NIT-510 | 5 x 10 | 365 | 10 | 24,46 |
| NIT-512 | 5 x 12 | 353 | 10 | 24,46 |
| NIT-514 | 5 x 14 | 327 | 10 | 24,46 |
| NIT-516 | 5 x 16 | 320 | 10 | 25,38 |
| NIT-518 | 5 x 18 | 291 | 10 | 25,38 |
| NIT-520 | 5 x 20 | 284 | 10 | 25,38 |
| NIT-522 | 5 x 22 | 270 | 10 | 25,38 |
| NIT-524 | 5 x 24 | 262 | 10 | 25,38 |
| NIT-526 | 5 x 26 | 251 | 10 | 26,00 |
| NIT-530 | 5 x 30 | 240 | 10 | 26,00 |
| NIT-610 | 6 x 10 | 234 | 10 | 28,46 |
| NIT-612 | 6 x 12 | 226 | 10 | 28,46 |
| NIT-614 | 6 x 14 | 207 | 10 | 28,46 |
| NIT-616 | 6 x 16 | 199 | 10 | 28,46 |
| NIT-618 | 6 x 18 | 194 | 10 | 28,46 |
| NIT-620 | 6 x 20 | 189 | 10 | 28,46 |

Nit zrywalny stal nierdzewna A2 (INOX/INOX)

Open type blind rivet with dome head - A2 INOX



| INDEX | ROZMIAR / SIZE d x L [mm] | ILOŚĆ [szt.] QUANTITY [pcs] | CENA / PRICE 1 kg [PLN] |
|-----------|---------------------------------|--------------------------------|-------------------------------|
| NITN-3006 | 3,0 x 6 | 1000 | 130,91 |
| NITN-3008 | 3,0 x 8 | 1000 | 163,64 |
| NITN-3010 | 3,0 x 10 | 1000 | 167,27 |
| NITN-3012 | 3,0 x 12 | 1000 | 181,82 |
| NITN-4006 | 4,0 x 6 | 500 | 163,64 |
| NITN-4008 | 4,0 x 8 | 500 | 203,64 |
| NITN-4010 | 4,0 x 10 | 500 | 207,27 |
| NITN-4012 | 4,0 x 12 | 500 | 229,09 |
| NITN-4014 | 4,0 x 14 | 500 | 243,64 |
| NITN-4016 | 4,0 x 16 | 500 | 247,27 |
| NITN-4806 | 4,8 x 6 | 500 | 192,73 |
| NITN-4808 | 4,8 x 8 | 500 | 240,00 |
| NITN-4810 | 4,8 x 10 | 500 | 243,64 |
| NITN-4812 | 4,8 x 12 | 500 | 269,09 |
| NITN-4814 | 4,8 x 14 | 500 | 287,27 |
| NITN-4816 | 4,8 x 16 | 500 | 290,91 |
| NITN-4825 | 4,8 x 25 | 500 | 436,36 |

Nit zrywalny Al / Fe lakierowany

Open type blind rivet with dome head - Al/Fe

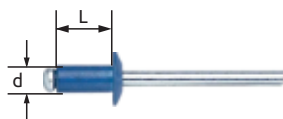

| INDEX | ROZMIAR / SIZE d x L [mm] | ILOŚĆ [szt./kg] QUANTITY [psc/kg] | ILOŚĆ [szt.] QUANTITY [pcs] | CENA / PRICE 1 kg [PLN] |
|-------------|---------------------------------|--------------------------------------|--------------------------------|-------------------------------|
| NITL410 RAL | 4 x 10 | 602 | 500 | 116,90 |
| NITL510 RAL | 5 x 10 | 365 | 500 | 163,00 |

DOSTĘPNE KOLORY / AVAILABLE COLOURS:
RAL1002, RAL3005, RAL3009, RAL3011, RAL6020, RAL7016, RAL7024,
RAL8003, RAL8004, RAL8017, RAL9004, RAL9005, RAL9006, RAL9010

Nit zrywalny Fe / Fe

Open type blind rivet with dome head - Fe/Fe

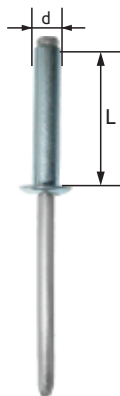

| INDEX | ROZMIAR / SIZE d x L [mm] | ILOŚĆ [szt.] QUANTITY [pcs] | CENA / PRICE 1000 szt./pcs [PLN] |
|-----------|---------------------------------|--------------------------------|--|
| NITS-3006 | 3,0 x 6 | 1000 | 47,90 |
| NITS-3008 | 3,0 x 8 | 1000 | 53,80 |
| NITS-3010 | 3,0 x 10 | 1000 | 61,00 |
| NITS-3012 | 3,0 x 12 | 1000 | 68,80 |
| NITS-3206 | 3,2 x 6 | 1000 | 53,40 |
| NITS-3210 | 3,2 x 10 | 1000 | 80,10 |
| NITS-4006 | 4,0 x 6 | 500 | 60,70 |
| NITS-4008 | 4,0 x 8 | 500 | 73,40 |
| NITS-4010 | 4,0 x 10 | 500 | 84,10 |
| NITS-4012 | 4,0 x 12 | 500 | 95,90 |
| NITS-4014 | 4,0 x 14 | 500 | 101,30 |
| NITS-4016 | 4,0 x 16 | 500 | 106,70 |
| NITS-4018 | 4,0 x 18 | 500 | 113,30 |
| NITS-4020 | 4,0 x 20 | 500 | 121,20 |
| NITS-4806 | 4,8 x 6 | 500 | 82,30 |
| NITS-4808 | 4,8 x 8 | 500 | 91,56 |
| NITS-4810 | 4,8 x 10 | 500 | 98,10 |
| NITS-4812 | 4,8 x 12 | 500 | 104,30 |
| NITS-4814 | 4,8 x 14 | 500 | 126,70 |
| NITS-4816 | 4,8 x 16 | 500 | 138,40 |
| NITS-4818 | 4,8 x 18 | 500 | 152,70 |
| NITS-4820 | 4,8 x 20 | 500 | 162,10 |
| NITS-4824 | 4,8 x 24 | 500 | 227,22 |

Nit zrywalny miedziano-stalowy Cu / Fe

Open type blind rivet with dome head - Cu/Fe

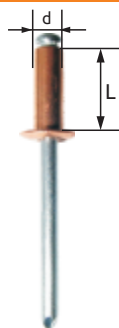

| INDEX | ROZMIAR / SIZE d x L [mm] | ILOŚĆ [szt.] QUANTITY [pcs] | CENA / PRICE 1000 szt./pcs [PLN] |
|------------|---------------------------------|--------------------------------|--|
| NITMS-4006 | 4,0 x 6 | 500 | 120,70 |
| NITMS-4008 | 4,0 x 8 | 500 | 140,00 |
| NITMS-4010 | 4,0 x 10 | 500 | 174,37 |
| NITMS-4012 | 4,0 x 12 | 500 | 203,43 |
| NITMS-4806 | 4,8 x 6 | 500 | 177,83 |
| NITMS-4808 | 4,8 x 8 | 500 | 180,00 |
| NITMS-4810 | 4,8 x 10 | 500 | 183,70 |
| NITMS-4812 | 4,8 x 12 | 500 | 261,57 |

Nitonakrętka stalowa

Rivet nut

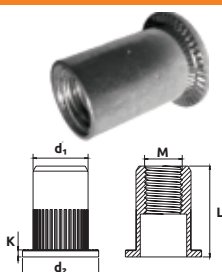

| INDEX | ROZMIAR SIZE [mm] | | | | | ILOŚĆ [szt.] QUANTITY [pcs] | | CENA / PRICE 1000 szt./pcs [PLN] |
|-----------|----------------------|----|----------------|----------------|------|--------------------------------|------|--|
| | M | L | d ₁ | d ₂ | K | | | |
| NITONA-04 | M4 | 11 | 6 | 9,0 | 0,90 | 500 | 4000 | 178,00 |
| NITONA-05 | M5 | 13 | 7 | 10,0 | 1,00 | 500 | 4000 | 222,00 |
| NITONA-06 | M6 | 15 | 9 | 12,2 | 1,20 | 250 | 1500 | 243,00 |
| NITONA-08 | M8 | 18 | 11 | 14,8 | 1,45 | 250 | 1500 | 289,50 |
| NITONA-10 | M10 | 21 | 13 | 17,1 | 1,80 | 150 | 900 | 537,67 |
| NITONA-12 | M12 | 25 | 15 | 19,0 | 1,90 | 100 | 600 | 1 112,11 |

Lina stalowa ocynkowana
Steel wire ropes, galvanized



1x7



1x19

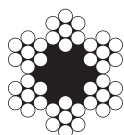

6x7

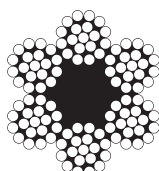

6x19

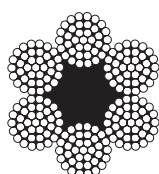

6x37

| INDEX | ŚREDNICA DIAMETER [mm] | KONSTRUKCJA TYPE | SIŁA ZRYWAJĄCA BREAKING FORCE [kg] | DIN | ILOŚĆ QUANTITY [m] | CENA / PRICE 1 mb [PLN] |
|-----------------|------------------------------|---------------------|--|------|---------------------------|-------------------------------|
| LSZ01.107.0200 | 1,0 | 1x7 | 95 | 3052 | 200 | 0,18 |
| LSZ01.119.0250 | 1,0 | 1x19 | 80 | 3053 | 250 | 0,22 |
| LSZ015.119.0200 | 1,5 | 1x19 | 211 | 3053 | 200 | 0,32 |
| LSZ015.119.1000 | 1,5 | 1x19 | 211 | 3053 | 1000 | 0,31 |
| LSZ02.119.0250 | 2,0 | 1x19 | 375 | 3053 | 250 | 0,52 |
| LSZ02.607.0200 | 2,0 | 6x7 | 235 | 3055 | 200 | 0,49 |
| LSZ03.607.0200 | 3,0 | 6x7 | 529 | 3055 | 200 | 0,82 |
| LSZ03.607.1000 | 3,0 | 6x7 | 529 | 3055 | 1000 | 0,78 |
| LSZ04.607.0150 | 4,0 | 6x7 | 940 | 3055 | 150 | 1,81 |
| LSZ04.619.0150 | 4,0 | 6x19 | 870 | 3060 | 150 | 2,12 |
| LSZ04.619.0250 | 4,0 | 6x19 | 870 | 3060 | 250 | 2,12 |
| LSZ04.619.1000 | 4,0 | 6x19 | 870 | 3060 | 1000 | 2,08 |
| LSZ05.607.0150 | 5,0 | 6x7 | 1460 | 3055 | 150 | 2,64 |
| LSZ05.619.0100 | 5,0 | 6x19 | 1360 | 3060 | 100 | 2,84 |
| LSZ05.619.1000 | 5,0 | 6x19 | 1360 | 3060 | 1000 | 2,68 |
| LSZ06.619.0100 | 6,0 | 6x19 | 1960 | 3060 | 100 | 3,74 |
| LSZ06.619.0200 | 6,0 | 6x19 | 1960 | 3060 | 200 | 3,70 |
| LSZ06.637.0200 | 6,0 | 6x37 | 1910 | 3066 | 200 | 4,58 |
| LSZ08.619.0050 | 8,0 | 6x19 | 3480 | 3060 | 50 | 5,98 |
| LSZ08.619.0100 | 8,0 | 6x19 | 3480 | 3060 | 100 | 5,92 |
| LSZ08.619.0200 | 8,0 | 6x19 | 3480 | 3060 | 200 | 5,90 |
| LSZ08.637.0050 | 8,0 | 6x37 | 3340 | 3066 | 50 | 6,62 |
| LSZ08.637.0100 | 8,0 | 6x37 | 3340 | 3066 | 100 | 6,57 |
| LSZ08.637.0200 | 8,0 | 6x37 | 3340 | 3066 | 200 | 6,46 |
| LSZ08.637.0500 | 8,0 | 6x37 | 3340 | 3066 | 500 | 6,38 |
| LSZ08.637.1000 | 8,0 | 6x37 | 3340 | 3066 | 1000 | 5,86 |
| LSZ10.619.0050 | 10,0 | 6x19 | 5430 | 3060 | 50 | 9,18 |
| LSZ10.619.0100 | 10,0 | 6x19 | 5430 | 3060 | 100 | 9,12 |
| LSZ10.619.0200 | 10,0 | 6x19 | 5430 | 3060 | 200 | 8,98 |
| LSZ10.619.0500 | 10,0 | 6x19 | 5430 | 3060 | 500 | 8,76 |
| LSZ10.619.1000 | 10,0 | 6x19 | 5430 | 3060 | 1000 | 8,60 |
| LSZ10.637.0050 | 10,0 | 6x37 | 5220 | 3066 | 50 | 9,92 |
| LSZ10.637.0100 | 10,0 | 6x37 | 5220 | 3066 | 100 | 9,62 |
| LSZ10.637.0200 | 10,0 | 6x37 | 5220 | 3066 | 200 | 9,50 |
| LSZ10.637.0500 | 10,0 | 6x37 | 5220 | 3066 | 500 | 9,38 |
| LSZ10.637.1000 | 10,0 | 6x37 | 5220 | 3066 | 1000 | 9,08 |
| LSZ11.637.0050 | 11,0 | 6x37 | 6320 | 3066 | 50 | 12,80 |
| LSZ12.619.0050 | 12,0 | 6x19 | 7820 | 3060 | 50 | 13,23 |
| LSZ12.619.0100 | 12,0 | 6x19 | 7820 | 3060 | 100 | 13,15 |
| LSZ12.619.0200 | 12,0 | 6x19 | 7820 | 3060 | 200 | 13,15 |
| LSZ12.637.0050 | 12,0 | 6x37 | 7530 | 3066 | 50 | 13,69 |
| LSZ12.637.0100 | 12,0 | 6x37 | 7530 | 3066 | 100 | 13,55 |
| LSZ12.637.0200 | 12,0 | 6x37 | 7530 | 3066 | 200 | 13,50 |
| LSZ12.637.0500 | 12,0 | 6x37 | 7530 | 3066 | 500 | 13,30 |
| LSZ12.637.1000 | 12,0 | 6x37 | 7530 | 3066 | 1000 | 13,00 |
| LSZ13.637.0050 | 13,0 | 6x37 | 8830 | 3066 | 50 | 15,23 |
| LSZ14.637.0050 | 14,0 | 6x37 | 10220 | 3066 | 50 | 17,85 |
| LSZ14.637.0100 | 14,0 | 6x37 | 10220 | 3066 | 100 | 17,69 |
| LSZ16.637.0050 | 16,0 | 6x37 | 13400 | 3066 | 50 | 22,77 |
| LSZ16.637.0100 | 16,0 | 6x37 | 13400 | 3066 | 100 | 22,62 |
| LSZ16.637.0500 | 16,0 | 6x37 | 13400 | 3066 | 500 | 22,46 |
| LSZ18.637.0050 | 18,0 | 6x37 | 17000 | 3066 | 50 | 28,62 |
| LSZ18.637.0100 | 18,0 | 6x37 | 17000 | 3066 | 100 | 27,80 |
| LSZ20.637.0050 | 20,0 | 6x37 | 20900 | 3066 | 50 | 32,46 |
| LSZ20.637.0100 | 20,0 | 6x37 | 20900 | 3066 | 100 | 32,15 |
| LSZ20.637.0500 | 20,0 | 6x37 | 20900 | 3066 | 500 | 31,85 |

Lina stalowa w powłoce PCV
Steel wire ropes, galvanized, PVC coated



| INDEX | ŚREDNICA ZEWNIĘTRZNA DIAMETER [mm] | ŚR. LINY STALOWEJ DIAMETER OF THE STEEL ROPE [mm] | KONSTRUKCJA TYPE | SIŁA ZRYWAJĄCA BREAKING FORCE [kg] | ILOŚĆ QUANTITY [mb] | CENA / PRICE 1 mb [PLN] |
|---------|---|--|---------------------|--|----------------------------|-------------------------------|
| LPS-02 | 2,0 | 1,0 | 1 x 7 | 95 | 500 | 0,38 |
| LPS-03 | 3,0 | 2,0 | 6 x 7 | 230 | 250 | 0,65 |
| LPS-04 | 4,0 | 3,0 | 6 x 7 | 539 | 200 | 1,05 |
| LPS-052 | 5,0 | 2,5 | 6 x 7 | 367 | 150 | 1,88 |
| LPS-054 | 5,0 | 4,0 | 6 x 7 | 958 | 150 | 2,17 |
| LPS-063 | 6,0 | 3,0 | 6 x 7 | 529 | 100 | 2,62 |
| LPS-065 | 6,0 | 5,0 | 6 x 7 | 958 | 100 | 3,06 |
| LPS-08 | 8,0 | 6,0 | 6 x 7 | 2100 | 50 | 5,08 |
| LPS-10 | 10,0 | 8,0 | 6 x 19 | 3480 | 50 | 7,43 |

Lina stalowa nierdzewna A4

A4 stainless steel wire rope



| INDEX | ŚREDNICA DIAMETER [mm] | KONSTRUKCJA TYPE | ILOŚĆ QUANTITY [mb] | CENA / PRICE 1 mb [PLN] |
|------------|------------------------------|---------------------|------------------------|-------------------------------|
| INOX-LSZ02 | 2,0 | 7 x 19 | 250 | 2,74 |
| INOX-LSZ03 | 3,0 | 7 x 19 | 250 | 4,15 |
| INOX-LSZ04 | 4,0 | 7 x 19 | 250 | 6,70 |
| INOX-LSZ05 | 5,0 | 7 x 19 | 250 | 10,25 |
| INOX-LSZ06 | 6,0 | 7 x 19 | 250 | 14,12 |
| INOX-LSZ08 | 8,0 | 7 x 19 | 250 | 24,49 |

Lina stalowa z pętelkami

Steel wire rope with loops

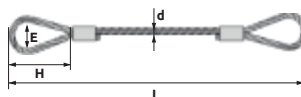

| INDEX | ŚREDNICA DIAMETER d [mm] | L [m] | E [mm] | H [mm] | ILOŚĆ QUANTITY [mb] | CENA / PRICE 1 szt./pcs [PLN] |
|-----------|--------------------------------|----------|-----------|-----------|------------------------|-------------------------------------|
| LSZP-0803 | 8,0 | 3 | 35 | 80 | 1 | 48,66 |
| LSZP-0805 | 8,0 | 5 | 35 | 80 | 1 | 68,97 |
| LSZP-1003 | 10,0 | 3 | 45 | 100 | 1 | 67,95 |
| LSZP-1005 | 10,0 | 5 | 45 | 100 | 1 | 99,23 |
| LSZP-1203 | 12,0 | 3 | 47 | 120 | 1 | 92,82 |
| LSZP-1205 | 12,0 | 5 | 47 | 120 | 1 | 136,40 |
| LSZP-1403 | 14,0 | 3 | 65 | 142 | 1 | 119,50 |
| LSZP-1405 | 14,0 | 5 | 65 | 142 | 1 | 176,40 |
| LSZP-1603 | 16,0 | 3 | 70 | 163 | 1 | 151,28 |
| LSZP-1605 | 16,0 | 5 | 70 | 163 | 1 | 224,60 |
| LSZP-1610 | 16,0 | 10 | 70 | 163 | 1 | 407,95 |
| LSZP-1805 | 18,0 | 5 | 80 | 180 | 1 | 271,60 |
| LSZP-2005 | 20,0 | 5 | 90 | 205 | 1 | 325,60 |
| LSZP-2010 | 20,0 | 10 | 90 | 205 | 1 | 582,00 |

Lina pleciona

Braided (polypropylene) twine



| INDEX | ŚREDNICA DIAMETER [mm] | ILOŚĆ QUANTITY [mb] | CENA / PRICE 1 mb [PLN] |
|-------|------------------------------|------------------------|-------------------------------|
| LP-02 | 2,0 | 600 | 0,18 |
| LP-03 | 3,0 | 500 | 0,30 |
| LP-04 | 4,0 | 400 | 0,36 |
| LP-05 | 5,0 | 300 | 0,52 |
| LP-06 | 6,0 | 300 | 0,79 |
| LP-08 | 8,0 | 300 | 1,35 |
| LP-10 | 10,0 | 200 | 1,72 |
| LP-12 | 12,0 | 150 | 2,20 |
| LP-14 | 14,0 | 100 | 3,05 |
| LP-16 | 16,0 | 80 | 3,90 |
| LP-18 | 18,0 | 60 | 4,90 |
| LP-20 | 20,0 | 50 | 6,50 |
| LP-24 | 24,0 | 20 | 10,33 |
| LP-26 | 26,0 | 20 | 12,17 |
| LP-28 | 28,0 | 20 | 15,75 |

Lina elastyczna

Braided flexible twine



| INDEX | ŚREDNICA DIAMETER [mm] | ILOŚĆ QUANTITY [mb] | CENA / PRICE 1 mb [PLN] |
|--------|------------------------------|------------------------|-------------------------------|
| LPG-04 | 4,0 | 200 | 1,10 |
| LPG-06 | 6,0 | 100 | 1,80 |
| LPG-08 | 8,0 | 100 | 2,25 |
| LPG-10 | 10,0 | 100 | 3,20 |
| LPG-12 | 12,0 | 80 | 4,20 |

Sznurek murarski

Mason twine



| INDEX | ILOŚĆ QUANTITY [mb] | CENA / PRICE 1 mb [PLN] |
|---------|------------------------|-------------------------------|
| SZM-50 | 50 | 5,20 |
| SZM-100 | 100 | 9,20 |

Lina jutowa

Jute twine



| INDEX | ŚREDNICA DIAMETER [mm] | ILOŚĆ QUANTITY [mb] | CENA / PRICE 1 szt./pcs [PLN] |
|---------|------------------------------|------------------------|-------------------------------------|
| LJ-1050 | 10,0 | 50 | 69,23 |
| LJ-1250 | 12,0 | 50 | 100,00 |
| LJ-1450 | 14,0 | 50 | 132,31 |
| LJ-1650 | 16,0 | 50 | 178,46 |
| LJ-1850 | 18,0 | 50 | 224,61 |
| LJ-2030 | 20,0 | 30 | 167,69 |
| LJ-2050 | 20,0 | 50 | 238,46 |

Błoczek budowlany Pulley



| INDEX | ROZMIAR KOŁA SIZE [mm] | MAKS. ŚREDNICA LINY MAX ROPE DIAMETER [mm] | MAKS. OBCIĄŻENIE ROBOCZE MAX WORK LOAD [kg] | ILOŚĆ [szt.] QUANTITY [pcs] | CENA / PRICE 1 szt. / pcs [PLN] |
|----------|---------------------------|--|---|--------------------------------|---------------------------------------|
| BLOB-100 | 100 | 20 | 150 | 10 | 53,00 |
| BLOB-165 | 165 | 22 | 200 | 10 | 88,09 |
| BLOB-200 | 200 | 24 | 200 | 8 | 142,46 |
| BLOB-250 | 250 | 26 | 250 | 4 | 200,95 |

Błoczek budowlany pojedynczy Single pulley

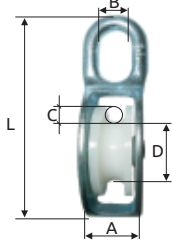

| INDEX | A [mm] | B [mm] | D [mm] | C [mm] | L [mm] | ILOŚĆ [szt.] QUANTITY [pcs] | CENA / PRICE 1 szt. / pcs [PLN] |
|----------|-----------|-----------|-----------|-----------|-----------|--------------------------------|---------------------------------------|
| BLO-1020 | 18,0 | 10,0 | 11,0 | 5,0 | 60,0 | 100 | 3,52 |
| BLO-1025 | 20,0 | 12,0 | 15,0 | 5,0 | 70,0 | 100 | 4,92 |
| BLO-1030 | 22,0 | 13,0 | 18,0 | 6,0 | 80,0 | 10 | 7,54 |
| BLO-1040 | 25,0 | 14,0 | 26,0 | 8,0 | 93,0 | 10 | 10,46 |
| BLO-1050 | 29,0 | 16,0 | 31,0 | 10,0 | 112,0 | 10 | 17,07 |

Błoczek budowlany podwójny Double pulley

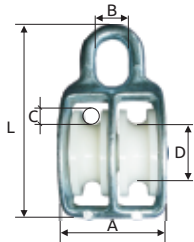

| INDEX | A [mm] | B [mm] | D [mm] | C [mm] | L [mm] | ILOŚĆ [szt.] QUANTITY [pcs] | CENA / PRICE 1 szt. / pcs [PLN] |
|----------|-----------|-----------|-----------|-----------|-----------|--------------------------------|---------------------------------------|
| BLO-2020 | 30,0 | 10,0 | 11,0 | 5,0 | 60,0 | 50 | 5,23 |
| BLO-2025 | 36,0 | 12,0 | 15,0 | 5,0 | 70,0 | 50 | 7,46 |
| BLO-2030 | 42,0 | 13,0 | 18,0 | 6,0 | 80,0 | 50 | 11,46 |
| BLO-2040 | 47,0 | 14,0 | 26,0 | 8,0 | 93,0 | 10 | 16,15 |
| BLO-2050 | 52,0 | 16,0 | 31,0 | 10,0 | 112,0 | 10 | 23,46 |

Kausza do lin stalowych, ocynkowana Wire rope thimble

DIN 6899 B

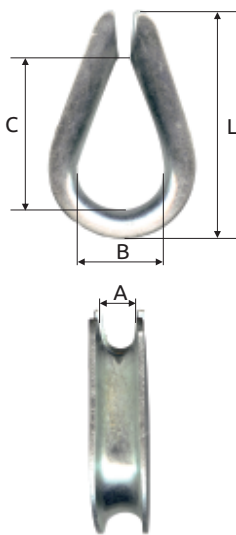

| INDEX | A [mm] | L [mm] | B [mm] | C [mm] | ILOŚĆ [szt.] QUANTITY [pcs] | CENA / PRICE 1 szt. / pcs [PLN] |
|-------|-----------|-----------|-----------|-----------|--------------------------------|---------------------------------------|
| KA-03 | 3,0 | 22,0 | 12,0 | 19,0 | 100 | 0,35 |
| KA-04 | 4,0 | 26,0 | 13,0 | 21,0 | 100 | 0,38 |
| KA-05 | 5,0 | 32,0 | 14,0 | 23,0 | 100 | 0,47 |
| KA-06 | 6,0 | 38,0 | 16,0 | 25,0 | 100 | 0,54 |
| KA-08 | 8,0 | 51,0 | 20,0 | 32,0 | 50 | 0,81 |
| KA-10 | 10,0 | 57,0 | 24,0 | 38,0 | 25 | 1,08 |
| KA-12 | 12,0 | 64,0 | 28,0 | 45,0 | 25 | 1,66 |
| KA-14 | 14,0 | 76,0 | 32,0 | 51,0 | 10 | 2,18 |
| KA-16 | 16,0 | 83,0 | 36,0 | 58,0 | 10 | 3,21 |
| KA-18 | 18,0 | 95,0 | 40,0 | 64,0 | 10 | 4,60 |
| KA-20 | 20,0 | 102,0 | 45,0 | 72,0 | 10 | 5,84 |
| KA-22 | 22,0 | 114,0 | 50,0 | 80,0 | 10 | 6,77 |
| KA-24 | 24,0 | 127,0 | 56,0 | 90,0 | 10 | 8,61 |
| KA-26 | 26,0 | 140,0 | 62,0 | 99,0 | 5 | 13,23 |
| KA-28 | 28,0 | 152,0 | 70,0 | 112,0 | 5 | 16,77 |
| KA-30 | 30,0 | 165,0 | 75,0 | 120,0 | 5 | 19,54 |

Zacisk siodełkowy pojedynczy

Single clamp

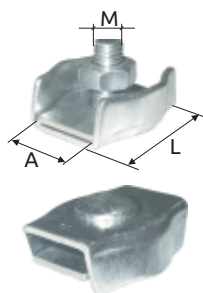

| INDEX | M | A [mm] | L [mm] | ILOŚĆ [szt.] QUANTITY [pcs] | CENA / PRICE 1 szt. / pcs [PLN] |
|---------|----|--------|--------|--------------------------------|---------------------------------------|
| ZACS-02 | M4 | 5,0 | 15,0 | 100 | 0,34 |
| ZACS-03 | M4 | 7,0 | 17,0 | 100 | 0,38 |
| ZACS-04 | M5 | 9,0 | 20,0 | 100 | 0,52 |
| ZACS-05 | M5 | 10,0 | 25,0 | 100 | 0,69 |
| ZACS-06 | M6 | 12,0 | 30,0 | 50 | 0,85 |
| ZACS-08 | M8 | 18,0 | 37,0 | 50 | 1,52 |

Zacisk siodełkowy podwójny

Double clamp

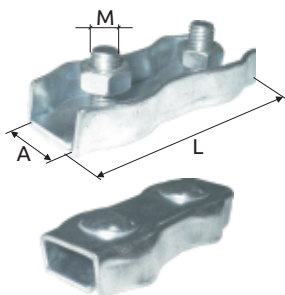

| INDEX | M | A [mm] | L [mm] | ILOŚĆ [szt.] QUANTITY [pcs] | CENA / PRICE 1 szt. / pcs [PLN] |
|----------|----|--------|--------|--------------------------------|---------------------------------------|
| ZACSP-02 | M4 | 5,0 | 30,0 | 100 | 0,52 |
| ZACSP-03 | M4 | 7,0 | 35,0 | 100 | 0,62 |
| ZACSP-04 | M5 | 9,0 | 40,0 | 100 | 0,82 |
| ZACSP-05 | M5 | 10,0 | 50,0 | 100 | 1,00 |
| ZACSP-06 | M6 | 12,0 | 60,0 | 25 | 1,42 |
| ZACSP-08 | M8 | 18,0 | 76,0 | 25 | 2,85 |

Zacisk linowy kubekowy, ocynkowany

Egg shaped wire rope clip

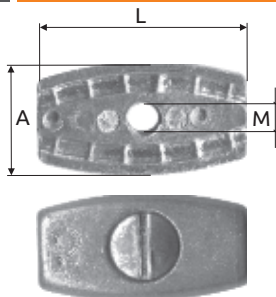

| INDEX | M | A [mm] | L [mm] | ILOŚĆ [szt.] QUANTITY [pcs] | CENA / PRICE 1 szt. / pcs [PLN] |
|---------|----|--------|--------|--------------------------------|---------------------------------------|
| ZACK-02 | M5 | 14,0 | 28,0 | 100 | 1,40 |
| ZACK-03 | M5 | 15,0 | 28,0 | 100 | 1,42 |
| ZACK-04 | M6 | 19,0 | 34,0 | 25 | 2,45 |
| ZACK-05 | M6 | 20,0 | 34,0 | 25 | 2,60 |
| ZACK-06 | M6 | 25,0 | 35,0 | 25 | 2,95 |

Zacisk do lin, ocynkowany

Wire rope clip

DIN 741

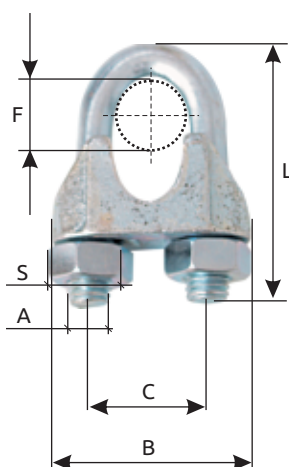

| INDEX | F [mm] | L [mm] | B [mm] | A [mm] | C [mm] | S [mm] | ILOŚĆ [szt.] QUANTITY [pcs] | CENA / PRICE 1 szt. / pcs [PLN] |
|--------|--------|--------|--------|--------|--------|--------|--------------------------------|---------------------------------------|
| ZAC-03 | 3,0 | 16,0 | 21,0 | 4,0 | 9,0 | 7 | 100 | 0,23 |
| ZAC-05 | 5,0 | 19,0 | 23,0 | 5,0 | 11,0 | 8 | 100 | 0,32 |
| ZAC-06 | 6,0 | 23,0 | 26,0 | 5,0 | 13,0 | 8 | 50 | 0,38 |
| ZAC-08 | 8,0 | 28,0 | 30,0 | 6,0 | 16,0 | 10 | 50 | 0,60 |
| ZAC-10 | 10,0 | 35,0 | 34,0 | 8,0 | 19,0 | 13 | 25 | 1,15 |
| ZAC-11 | 11,0 | 37,0 | 36,0 | 8,0 | 20,0 | 13 | 25 | 1,26 |
| ZAC-12 | 12,0 | 45,0 | 42,0 | 10,0 | 24,0 | 17 | 10 | 2,00 |
| ZAC-13 | 13,0 | 45,0 | 42,0 | 10,0 | 24,0 | 17 | 10 | 2,20 |
| ZAC-14 | 14,0 | 46,0 | 44,0 | 10,0 | 25,0 | 17 | 10 | 2,31 |
| ZAC-16 | 16,0 | 51,0 | 50,0 | 12,0 | 29,0 | 19 | 10 | 3,31 |
| ZAC-19 | 19,0 | 62,0 | 54,0 | 12,0 | 32,0 | 19 | 10 | 4,15 |
| ZAC-22 | 22,0 | 72,0 | 61,0 | 14,0 | 37,0 | 22 | 5 | 6,40 |
| ZAC-24 | 24,0 | 75,0 | 63,0 | 14,0 | 39,0 | 22 | 5 | 6,69 |
| ZAC-26 | 26,0 | 76,0 | 65,0 | 14,0 | 41,0 | 22 | 5 | 7,02 |
| ZAC-30 | 30,0 | 95,0 | 74,0 | 16,0 | 48,0 | 24 | 5 | 11,06 |
| ZAC-34 | 34,0 | 105,0 | 80,0 | 16,0 | 52,0 | 24 | 5 | 12,63 |
| ZAC-40 | 40,0 | 125,0 | 88,0 | 16,0 | 58,0 | 24 | 5 | 16,38 |

Szekla JIS Type D shackle

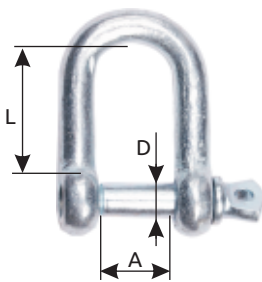

| INDEX | D [mm] | A [mm] | L [mm] | ILOŚĆ [szt.] QUANTITY [pcs] | CENA / PRICE 1 szt. / pcs [PLN] |
|---------|--------|--------|--------|--------------------------------|---------------------------------------|
| SZE-035 | 3,9 | 9,0 | 16,0 | 100 | 0,95 |
| SZE-05 | 5,0 | 10,0 | 18,0 | 100 | 0,98 |
| SZE-06 | 6,0 | 12,0 | 22,0 | 100 | 1,06 |
| SZE-08 | 7,0 | 15,0 | 30,0 | 100 | 1,46 |
| SZE-10 | 8,5 | 18,0 | 31,0 | 25 | 2,38 |
| SZE-12 | 10,5 | 22,0 | 36,0 | 25 | 3,61 |
| SZE-14 | 12,0 | 25,0 | 49,0 | 10 | 6,46 |
| SZE-16 | 14,5 | 30,0 | 50,0 | 5 | 8,75 |
| SZE-18 | 16,0 | 33,0 | 61,0 | 5 | 12,63 |
| SZE-20 | 20,0 | 38,0 | 55,0 | 5 | 16,23 |
| SZE-22 | 20,0 | 40,0 | 60,0 | 5 | 20,85 |
| SZE-25 | 22,0 | 43,0 | 60,0 | 5 | 32,28 |
| SZE-28 | 25,0 | 48,0 | 82,0 | 5 | 41,92 |
| SZE-32 | 32,0 | 64,0 | 113,0 | 3 | 65,21 |
| SZE-38 | 38,0 | 76,0 | 125,0 | 3 | 118,80 |
| SZE-45 | 45,0 | 80,0 | 137,0 | 3 | 230,76 |

Szekla specjalna European type Dee shackle

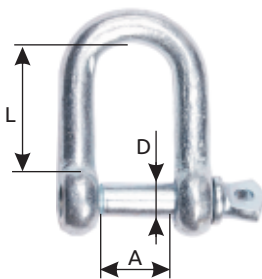

| INDEX | D [mm] | A [mm] | L [mm] | ILOŚĆ [szt.] QUANTITY [pcs] | CENA / PRICE 1 szt. / pcs [PLN] |
|---------|--------|--------|--------|--------------------------------|---------------------------------------|
| SZED-05 | 5,0 | 10,0 | 19,0 | 100 | 1,46 |
| SZED-06 | 6,0 | 13,0 | 24,0 | 100 | 1,75 |
| SZED-08 | 8,0 | 16,0 | 32,0 | 25 | 2,08 |
| SZED-10 | 10,0 | 20,0 | 40,0 | 25 | 3,18 |
| SZED-12 | 12,0 | 25,0 | 48,0 | 10 | 4,08 |
| SZED-14 | 13,0 | 26,0 | 49,0 | 10 | 7,20 |
| SZED-16 | 15,0 | 32,0 | 58,0 | 5 | 9,25 |
| SZED-18 | 17,0 | 32,0 | 69,0 | 5 | 13,67 |
| SZED-20 | 20,0 | 38,0 | 82,0 | 5 | 17,26 |
| SZED-22 | 20,0 | 38,0 | 75,0 | 5 | 22,43 |
| SZED-25 | 25,0 | 46,0 | 90,0 | 5 | 38,78 |

Szekla Omega Shackle bow / Omega type

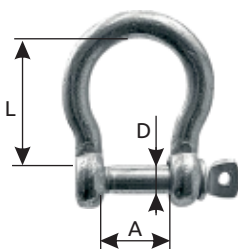

| INDEX | D [mm] | A [mm] | L [mm] | ILOŚĆ [szt.] QUANTITY [pcs] | CENA / PRICE 1 szt. / pcs [PLN] |
|---------|--------|--------|--------|--------------------------------|---------------------------------------|
| SZEO-05 | 5,0 | 10,0 | 19,5 | 50 | 1,02 |
| SZEO-06 | 6,0 | 13,5 | 26,0 | 50 | 1,19 |
| SZEO-08 | 8,0 | 16,0 | 30,0 | 50 | 1,92 |
| SZEO-10 | 10,0 | 19,0 | 36,0 | 10 | 3,23 |
| SZEO-12 | 12,0 | 25,0 | 49,0 | 10 | 5,08 |
| SZEO-14 | 13,0 | 28,0 | 52,0 | 10 | 7,83 |
| SZEO-16 | 15,0 | 32,0 | 64,0 | 5 | 11,31 |
| SZEO-18 | 17,0 | 30,0 | 71,0 | 5 | 16,77 |
| SZEO-20 | 20,0 | 38,0 | 75,0 | 5 | 21,08 |

Śruba rzymska - korpus Turnbuckle

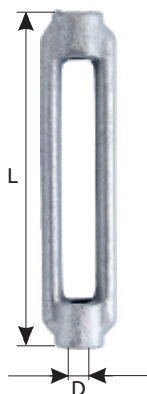

| INDEX | D [mm] | L [mm] | ILOŚĆ [szt.] QUANTITY [pcs] | CENA / PRICE 1 szt. / pcs [PLN] |
|---------|--------|--------|--------------------------------|---------------------------------------|
| ŚRZK-06 | 6,0 | 88,0 | 50 | 2,26 |
| ŚRZK-08 | 8,0 | 110,0 | 50 | 3,11 |
| ŚRZK-10 | 10,0 | 130,0 | 25 | 4,43 |
| ŚRZK-12 | 12,0 | 140,0 | 10 | 6,06 |
| ŚRZK-14 | 14,0 | 170,0 | 10 | 9,68 |
| ŚRZK-16 | 16,0 | 190,0 | 10 | 12,13 |
| ŚRZK-18 | 18,0 | 200,0 | 5 | 20,96 |
| ŚRZK-20 | 20,0 | 220,0 | 5 | 22,53 |
| ŚRZK-24 | 24,0 | 255,0 | 5 | 42,82 |
| ŚRZK-30 | 30,0 | 255,0 | 5 | 65,16 |
| ŚRZK-32 | 32,0 | 255,0 | 5 | 82,05 |

Śruba rzyska hak - ucho

Turnbuckle hook-eye

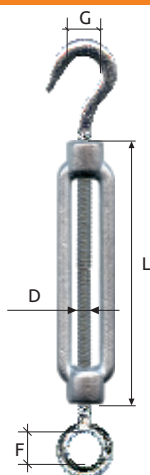

| INDEX | D [mm] | L [mm] | G [mm] | F [mm] | ILOŚĆ [szt.] QUANTITY [pcs] | CENA / PRICE 1 szt. / pcs [PLN] |
|--------|--------|--------|--------|--------|--------------------------------|---------------------------------------|
| ŚRZ-05 | 5,0 | 79,0 | 6,0 | 8,0 | 25 | 2,29 |
| ŚRZ-06 | 6,0 | 88,0 | 8,5 | 10,0 | 25 | 2,69 |
| ŚRZ-08 | 8,0 | 110,0 | 10,0 | 11,0 | 10 | 3,63 |
| ŚRZ-10 | 10,0 | 130,0 | 12,0 | 14,0 | 10 | 5,23 |
| ŚRZ-12 | 12,0 | 140,0 | 16,0 | 17,0 | 5 | 8,60 |
| ŚRZ-14 | 14,0 | 170,0 | 16,0 | 18,0 | 5 | 11,77 |
| ŚRZ-16 | 16,0 | 190,0 | 16,5 | 23,0 | 5 | 16,08 |
| ŚRZ-18 | 18,0 | 200,0 | 17,0 | 25,0 | 5 | 24,49 |
| ŚRZ-20 | 20,0 | 220,0 | 17,5 | 25,0 | 5 | 29,77 |
| ŚRZ-24 | 24,0 | 255,0 | 23,0 | 34,0 | 5 | 50,94 |
| ŚRZ-30 | 30,0 | 255,0 | 29,0 | 38,0 | 5 | 99,51 |
| ŚRZ-32 | 32,0 | 255,0 | 29,0 | 39,0 | 5 | 115,00 |

Śruba rzyska hak - hak

Turnbuckle hook-hook

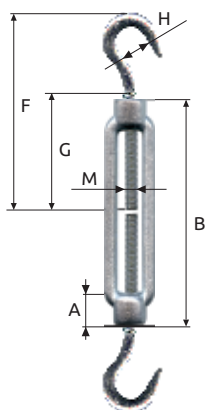

| INDEX | M [mm] | A [mm] | B [mm] | F [mm] | G [mm] | H [mm] | ILOŚĆ [szt.] QUANTITY [pcs] | CENA / PRICE 1 szt. / pcs [PLN] |
|---------|--------|--------|--------|--------|--------|--------|--------------------------------|---------------------------------------|
| ŚRZH-05 | 5,0 | 9,0 | 79,0 | 62,0 | 40,0 | 6,0 | 25 | 2,29 |
| ŚRZH-06 | 6,0 | 10,0 | 88,0 | 76,0 | 50,0 | 8,5 | 25 | 2,69 |
| ŚRZH-08 | 8,0 | 12,0 | 110,0 | 89,0 | 52,0 | 10,0 | 10 | 3,63 |
| ŚRZH-10 | 10,0 | 15,0 | 130,0 | 103,0 | 62,0 | 12,0 | 10 | 5,23 |
| ŚRZH-12 | 12,0 | 18,0 | 140,0 | 121,0 | 65,0 | 16,0 | 5 | 8,60 |
| ŚRZH-14 | 14,0 | 20,0 | 170,0 | 144,0 | 82,0 | 16,0 | 5 | 11,77 |
| ŚRZH-16 | 16,0 | 22,5 | 190,0 | 172,0 | 105,0 | 16,5 | 5 | 16,08 |
| ŚRZH-20 | 20,0 | 30,0 | 220,0 | 185,0 | 110,0 | 17,5 | 5 | 29,77 |
| ŚRZH-24 | 24,0 | 39,0 | 255,0 | 225,0 | 135,0 | 23,0 | 5 | 50,94 |
| ŚRZH-32 | 34,0 | 45,0 | 255,0 | 250,0 | 145,0 | 29,0 | 5 | 115,00 |

Śruba rzyska ucho - ucho

Turnbuckle eye-eye

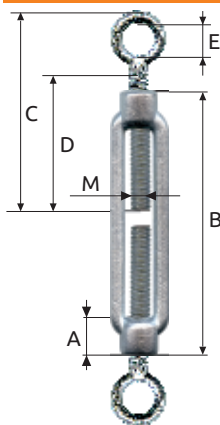

| INDEX | M [mm] | A [mm] | B [mm] | C [mm] | D [mm] | E [mm] | ILOŚĆ [szt.] QUANTITY [pcs] | CENA / PRICE 1 szt. / pcs [PLN] |
|---------|--------|--------|--------|--------|--------|--------|--------------------------------|---------------------------------------|
| ŚRZU-05 | 5,0 | 9,0 | 79,0 | 59,0 | 40,0 | 8,0 | 25 | 2,29 |
| ŚRZU-06 | 6,0 | 10,0 | 88,0 | 74,0 | 50,0 | 10,0 | 25 | 2,69 |
| ŚRZU-08 | 8,0 | 12,0 | 110,0 | 80,0 | 52,0 | 11,0 | 10 | 3,63 |
| ŚRZU-10 | 10,0 | 15,0 | 130,0 | 97,0 | 60,0 | 14,0 | 10 | 5,23 |
| ŚRZU-12 | 12,0 | 18,0 | 140,0 | 106,0 | 67,0 | 17,0 | 5 | 8,60 |
| ŚRZU-14 | 14,0 | 20,0 | 170,0 | 126,0 | 83,0 | 18,0 | 5 | 11,77 |
| ŚRZU-16 | 16,0 | 22,5 | 190,0 | 160,0 | 97,0 | 23,0 | 5 | 16,08 |
| ŚRZU-18 | 18,0 | 27,0 | 200,0 | 178,0 | 112,0 | 25,0 | 5 | 24,49 |
| ŚRZU-20 | 20,0 | 30,0 | 220,0 | 190,0 | 116,0 | 25,0 | 5 | 29,77 |
| ŚRZU-24 | 24,0 | 39,0 | 255,0 | 210,0 | 125,0 | 34,0 | 5 | 50,94 |

Śruba rzyska prosta

Turnbuckle straight ends

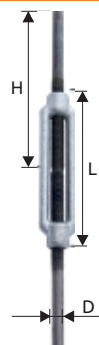

| INDEX | D [mm] | L [mm] | H [mm] | ILOŚĆ [szt.] QUANTITY [pcs] | CENA / PRICE 1 szt. / pcs [PLN] |
|---------|--------|--------|--------|--------------------------------|---------------------------------------|
| ŚRZP-08 | 8,0 | 110,0 | 120,0 | 25 | 4,16 |
| ŚRZP-10 | 10,0 | 130,0 | 150,0 | 25 | 5,07 |
| ŚRZP-12 | 12,0 | 140,0 | 150,0 | 10 | 7,49 |
| ŚRZP-14 | 14,0 | 170,0 | 180,0 | 10 | 11,90 |
| ŚRZP-16 | 16,0 | 190,0 | 200,0 | 5 | 16,20 |
| ŚRZP-20 | 20,0 | 220,0 | 220,0 | 5 | 29,90 |
| ŚRZP-24 | 24,0 | 255,0 | 260,0 | 5 | 47,06 |
| ŚRZP-30 | 30,0 | 255,0 | 260,0 | 5 | 76,02 |

Śruba rzymska hak - ucho

Turnbuckle hook-eye

DIN 1480

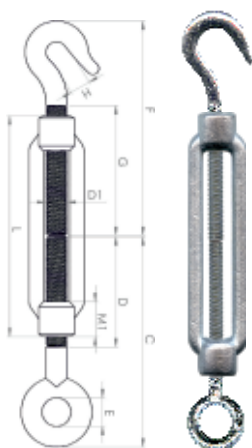

| INDEX | D1 [mm] | M1 [mm] | L [mm] | C [mm] | D [mm] | E [mm] | F [mm] | G [mm] | H [mm] | ILOŚĆ [szt.] QUANTITY [pcs] | CENA / PRICE 1 szt. / pcs [PLN] |
|---------|---------|---------|--------|--------|--------|--------|--------|--------|--------|--------------------------------|---------------------------------------|
| ŚRZD-05 | M5 | 9 | 70 | 52 | 33 | 8 | 56 | 33 | 7,0 | 50 | 3,29 |
| ŚRZD-06 | M6 | 12 | 110 | 74 | 50 | 10 | 76 | 50 | 8,5 | 25 | 4,60 |
| ŚRZD-08 | M8 | 15 | 110 | 80 | 52 | 11 | 89 | 52 | 10,0 | 25 | 5,95 |
| ŚRZD-10 | M10 | 18 | 125 | 97 | 60 | 14 | 103 | 62 | 12,0 | 10 | 8,95 |
| ŚRZD-12 | M12 | 21 | 125 | 106 | 67 | 17 | 121 | 65 | 16,0 | 10 | 12,98 |
| ŚRZD-14 | M14 | 23 | 140 | 126 | 83 | 18 | 144 | 82 | 16,0 | 5 | 16,46 |
| ŚRZD-16 | M16 | 27 | 170 | 160 | 97 | 23 | 172 | 105 | 16,5 | 5 | 23,85 |
| ŚRZD-18 | M18 | 32 | 200 | 165 | 110 | 23 | 200 | 110 | 18,0 | 5 | 40,72 |
| ŚRZD-20 | M20 | 34 | 200 | 190 | 116 | 25 | 185 | 110 | 17,5 | 5 | 45,23 |
| ŚRZD-24 | M24 | 39 | 255 | 210 | 125 | 34 | 225 | 135 | 23,0 | 5 | 74,72 |
| ŚRZD-30 | M30 | 45 | 255 | 240 | 150 | 38 | 250 | 145 | 29,0 | 5 | 114,02 |

Śruba rzymska hak - hak

Turnbuckle hook-hook

DIN 1480

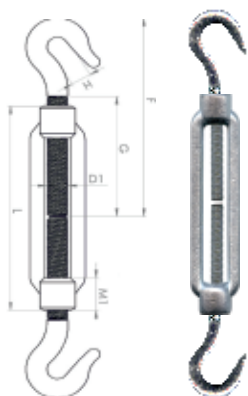

| INDEX | D1 [mm] | M1 [mm] | L [mm] | F [mm] | G [mm] | H [mm] | ILOŚĆ [szt.] QUANTITY [pcs] | CENA / PRICE 1 szt. / pcs [PLN] |
|----------|---------|---------|--------|--------|--------|--------|--------------------------------|---------------------------------------|
| SRZDHH05 | M5 | 9 | 70 | 56 | 33 | 7,0 | 50 | 3,29 |
| SRZDHH06 | M6 | 12 | 110 | 76 | 50 | 8,5 | 25 | 4,60 |
| SRZDHH08 | M8 | 15 | 110 | 89 | 52 | 10,0 | 25 | 5,95 |
| SRZDHH10 | M10 | 18 | 125 | 103 | 62 | 12,0 | 10 | 8,95 |
| SRZDHH12 | M12 | 21 | 125 | 121 | 65 | 16,0 | 10 | 12,98 |
| SRZDHH14 | M14 | 23 | 140 | 144 | 82 | 16,0 | 5 | 16,46 |
| SRZDHH16 | M16 | 27 | 170 | 172 | 105 | 16,5 | 5 | 23,85 |
| SRZDHH18 | M18 | 32 | 200 | 200 | 110 | 18,0 | 5 | 40,72 |
| SRZDHH20 | M20 | 34 | 200 | 185 | 110 | 17,5 | 5 | 45,23 |
| SRZDHH24 | M24 | 39 | 255 | 225 | 135 | 23,0 | 5 | 74,72 |
| SRZDHH30 | M30 | 45 | 255 | 250 | 145 | 29,0 | 5 | 114,02 |

Śruba rzymska ucho - ucho

Turnbuckle eye-eye

DIN 1480

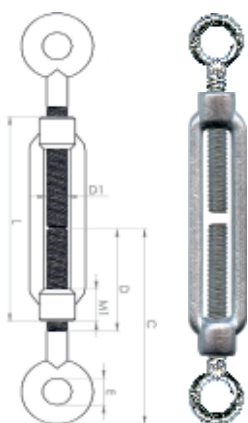

| INDEX | D1 [mm] | M1 [mm] | L [mm] | C [mm] | D [mm] | E [mm] | ILOŚĆ [szt.] QUANTITY [pcs] | CENA / PRICE 1 szt. / pcs [PLN] |
|----------|---------|---------|--------|--------|--------|--------|--------------------------------|---------------------------------------|
| SRZDUU05 | M5 | 9 | 70 | 52 | 33 | 8 | 50 | 3,29 |
| SRZDUU06 | M6 | 12 | 110 | 74 | 50 | 10 | 25 | 4,60 |
| SRZDUU08 | M8 | 15 | 110 | 80 | 52 | 11 | 25 | 5,95 |
| SRZDUU10 | M10 | 18 | 125 | 97 | 60 | 14 | 10 | 8,95 |
| SRZDUU12 | M12 | 21 | 125 | 106 | 67 | 17 | 10 | 12,98 |
| SRZDUU14 | M14 | 23 | 140 | 126 | 83 | 18 | 5 | 16,46 |
| SRZDUU16 | M16 | 27 | 170 | 160 | 97 | 23 | 5 | 23,85 |
| SRZDUU18 | M18 | 32 | 200 | 165 | 110 | 23 | 5 | 40,72 |
| SRZDUU20 | M20 | 34 | 200 | 190 | 116 | 25 | 5 | 45,23 |
| SRZDUU24 | M24 | 39 | 255 | 210 | 125 | 34 | 5 | 74,72 |
| SRZDUU30 | M30 | 45 | 255 | 240 | 150 | 38 | 5 | 114,02 |

Hak huštawkowy z karabińczykiem

Swing hook with carabiner



| INDEX | ROZMIAR SIZE [mm] | ILOŚĆ [szt.] QUANTITY [pcs] | CENA / PRICE 1 szt. / pcs [PLN] |
|----------|----------------------|--------------------------------|---------------------------------------|
| HHK10140 | M10 x 140 | 20 | 10,30 |

Hak huštawkowy z szekłą

Swing hook with a shackle



| INDEX | ROZMIAR SIZE [mm] | ILOŚĆ [szt.] QUANTITY [pcs] | CENA / PRICE 1 szt. / pcs [PLN] |
|----------|----------------------|--------------------------------|---------------------------------------|
| HHS10200 | M10 x 200 | 20 | 11,80 |
| HHS12200 | M12 x 200 | 20 | 13,70 |

Hak zwykły

Hook

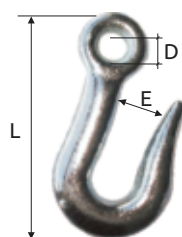

| INDEX | D [mm] | E [mm] | L [mm] | ILOŚĆ [szt.] QUANTITY [pcs] | CENA / PRICE 1 szt. / pcs [PLN] |
|--------|-----------|-----------|-----------|--------------------------------|---------------------------------------|
| HAK-05 | 8,5 | 13,0 | 56,0 | 25 | 1,83 |
| HAK-06 | 9,0 | 15,0 | 68,0 | 10 | 2,29 |
| HAK-07 | 10,0 | 16,0 | 80,0 | 10 | 3,46 |
| HAK-08 | 11,0 | 17,0 | 89,0 | 10 | 4,45 |
| HAK-09 | 12,0 | 18,0 | 100,0 | 10 | 6,29 |
| HAK-10 | 12,5 | 18,0 | 113,0 | 5 | 8,89 |
| HAK-12 | 15,0 | 20,0 | 118,0 | 5 | 10,26 |

Hak z zabezpieczeniem i uchem, ocynkowany lub lakierowany

Hook with latch

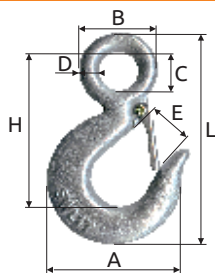

| INDEX | UDŹWIG CAPACITY [kg] | A [mm] | B [mm] | C [mm] | D [mm] | E [mm] | H [mm] | L [mm] | ILOŚĆ [szt.] QUANTITY [pcs] | CENA / PRICE 1 szt. / pcs [PLN] |
|-----------|----------------------------|-----------|-----------|-----------|-----------|-----------|-----------|-----------|--------------------------------|---------------------------------------|
| HAKU-0750 | 750 | 67 | 38 | 19,5 | 9,25 | 25 | 81,0 | 110 | 5 | 7,85 |
| HAKU-1000 | 1000 | 77 | 45 | 22,0 | 11,50 | 26 | 93,0 | 125 | 5 | 11,08 |
| HAKU-1500 | 1500 | 86 | 52 | 28,0 | 12,00 | 28 | 103,0 | 140 | 5 | 15,37 |
| HAKU-2000 | 2000 | 97 | 62 | 31,0 | 15,50 | 31 | 119,0 | 163 | 5 | 22,62 |
| HAKU-3000 | 3000 | 123 | 74 | 39,0 | 17,50 | 39 | 147,0 | 201 | 5 | 38,15 |
| HAKU-5000 | 5000 | 149 | 95 | 51,0 | 22,00 | 47 | 185,5 | 255 | 5 | 76,58 |

Hak z zabezpieczeniem, ocynkowany lub lakierowany

Hook with latch

DIN 689

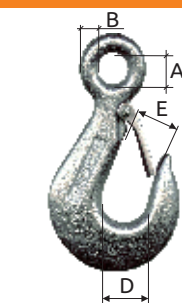

| INDEX | UDŹWIG CAPACITY [kg] | A [mm] | B [mm] | D [mm] | E [mm] | ILOŚĆ [szt.] QUANTITY [pcs] | CENA / PRICE 1 szt. / pcs [PLN] |
|-----------|----------------------------|-----------|-----------|-----------|-----------|--------------------------------|---------------------------------------|
| HAKZ-0250 | 250 | 9,5 | 7,5 | 23,0 | 18,0 | 10 | 6,91 |
| HAKZ-0500 | 500 | 12,5 | 10,0 | 31,0 | 24,0 | 5 | 10,25 |
| HAKZ-1000 | 1000 | 18,0 | 13,0 | 42,0 | 33,0 | 5 | 23,92 |
| HAKZ-1600 | 1600 | 24,0 | 16,0 | 50,0 | 39,0 | 5 | 36,57 |
| HAKZ-2500 | 2500 | 25,0 | 20,0 | 58,0 | 49,0 | 5 | 74,17 |

Hak sworzniowy, ocynkowany

Heavy-duty hook

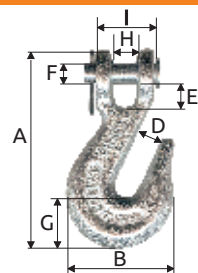

| INDEX | UDŹWIG CAPACITY [kg] | A [mm] | B [mm] | D [mm] | E [mm] | F [mm] | G [mm] | H [mm] | I [mm] | ILOŚĆ [szt.] QUANTITY [pcs] | CENA / PRICE 1 szt. / pcs [PLN] |
|----------|----------------------------|-----------|-----------|-----------|-----------|-----------|-----------|-----------|-----------|--------------------------------|---------------------------------------|
| HAKS-014 | 1180 | 78 | 47 | 9,0 | 8,5 | 9,3 | 19,0 | 8,0 | 26 | 10 | 6,71 |
| HAKS-516 | 1770 | 96 | 54 | 11,5 | 10,5 | 10,2 | 25,0 | 11,0 | 30 | 10 | 10,16 |
| HAKS-038 | 2450 | 114 | 65 | 12,5 | 13,0 | 11,5 | 30,5 | 12,5 | 37 | 10 | 14,55 |

Hak obrotowy z zabezpieczeniem - ocynkowany lub lakierowany

Painted swivel hook with latch

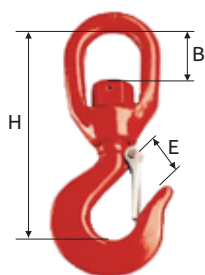

| INDEX | UDŹWIG CAPACITY [kg] | B [mm] | E [mm] | H [mm] | ILOŚĆ [szt.] QUANTITY [pcs] | CENA / PRICE 1 szt. / pcs [PLN] |
|-----------|----------------------------|-----------|-----------|-----------|--------------------------------|---------------------------------------|
| HAKO-0750 | 750 | 24,0 | 22,0 | 114,0 | 5 | 16,50 |
| HAKO-1000 | 1000 | 33,0 | 24,0 | 135,0 | 5 | 22,58 |
| HAKO-1500 | 1500 | 41,0 | 25,0 | 153,0 | 5 | 32,26 |
| HAKO-2000 | 2000 | 43,0 | 28,0 | 162,0 | 5 | 36,88 |
| HAKO-3000 | 3000 | 45,0 | 34,0 | 188,0 | 5 | 84,00 |
| HAKO-5000 | 5000 | 64,0 | 42,0 | 245,0 | 5 | 142,31 |

Ogniwo typ S - ocynkowane

Quick link type S (S light hook)

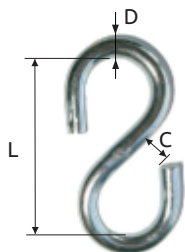

| INDEX | D [mm] | L [mm] | C [mm] | ILOŚĆ [szt.] QUANTITY [pcs] | CENA / PRICE 1 szt. / pcs [PLN] |
|--------|-----------|-----------|-----------|--------------------------------|---------------------------------------|
| OGN-03 | 3,0 | 28,0 | 3,5 | 100 | 0,16 |
| OGN-04 | 4,0 | 32,0 | 4,0 | 100 | 0,25 |
| OGN-05 | 5,0 | 38,0 | 6,0 | 100 | 0,44 |
| OGN-06 | 6,0 | 50,0 | 7,0 | 100 | 0,65 |
| OGN-07 | 7,0 | 55,0 | 8,0 | 50 | 1,06 |
| OGN-08 | 8,0 | 60,0 | 10,0 | 50 | 1,63 |

Ogniwo zaklepywane - ocynkowane

Repair link

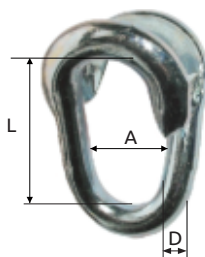

| INDEX | D [mm] | L [mm] | A [mm] | ILOŚĆ [szt.] QUANTITY [pcs] | CENA / PRICE 1 szt. / pcs [PLN] |
|--------|-----------|-----------|-----------|--------------------------------|---------------------------------------|
| OGZ-04 | 4,0 | 24,0 | 7,5 | 100 | 0,38 |
| OGZ-05 | 5,0 | 28,0 | 9,5 | 100 | 0,65 |
| OGZ-06 | 6,0 | 33,0 | 12,0 | 50 | 0,89 |
| OGZ-07 | 7,0 | 36,0 | 14,0 | 50 | 1,15 |
| OGZ-08 | 8,0 | 40,0 | 17,0 | 25 | 1,85 |
| OGZ-10 | 10,0 | 52,0 | 22,0 | 25 | 3,20 |

Ogniwo skręcane - ocynkowane

Quick link



| INDEX | D [mm] | L [mm] | A [mm] | ILOŚĆ [szt.] QUANTITY [pcs] | CENA / PRICE 1 szt. / pcs [PLN] |
|--------|-----------|-----------|-----------|--------------------------------|---------------------------------------|
| OGS-04 | 4,0 | 43,0 | 19,0 | 100 | 0,85 |
| OGS-05 | 5,0 | 50,0 | 22,0 | 100 | 1,08 |
| OGS-06 | 6,0 | 59,0 | 26,0 | 100 | 1,32 |
| OGS-07 | 7,0 | 67,0 | 30,0 | 50 | 1,97 |
| OGS-08 | 8,0 | 74,0 | 34,0 | 10 | 2,38 |
| OGS-10 | 10,0 | 90,0 | 40,0 | 10 | 4,31 |
| OGS-12 | 12,0 | 110,0 | 49,0 | 10 | 7,15 |
| OGS-14 | 14,0 | 123,0 | 54,0 | 5 | 16,69 |
| OGS-16 | 16,0 | 141,0 | 62,0 | 5 | 23,38 |

Kółko zgrzewane - ocynkowane

Steel welded ring



| INDEX | D [mm] | D ₁ [mm] | ILOŚĆ [szt.] QUANTITY [pcs] | CENA / PRICE 1 szt. / pcs [PLN] |
|--------|-----------|------------------------|--------------------------------|---------------------------------------|
| KZ-325 | 3 | 25 | 50 | 0,85 |
| KZ-330 | 3 | 30 | 50 | 0,87 |
| KZ-425 | 4 | 25 | 50 | 0,97 |
| KZ-430 | 4 | 30 | 50 | 1,05 |
| KZ-525 | 5 | 25 | 50 | 1,13 |
| KZ-530 | 5 | 30 | 50 | 1,18 |
| KZ-535 | 5 | 35 | 50 | 1,31 |
| KZ-635 | 6 | 35 | 50 | 1,61 |
| KZ-645 | 6 | 45 | 50 | 1,82 |
| KZ-735 | 7 | 35 | 50 | 2,31 |
| KZ-835 | 8 | 35 | 50 | 2,72 |
| KZ-845 | 8 | 45 | 50 | 2,82 |

Śruba z uchem

Eye screw

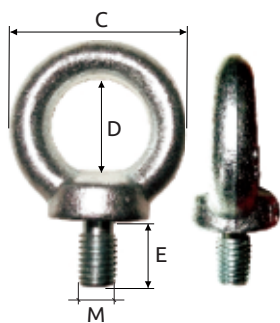

| INDEX | M | C [mm] | D [mm] | E [mm] | ILOŚĆ [szt.] QUANTITY [pcs] | CENA / PRICE 1 szt. / pcs [PLN] |
|--------|-----|--------|--------|--------|--------------------------------|---------------------------------------|
| ŚRU-06 | M6 | 26,0 | 16,0 | 14,0 | 50 | 1,83 |
| ŚRU-08 | M8 | 32,6 | 20,0 | 15,0 | 50 | 1,86 |
| ŚRU-10 | M10 | 41,0 | 25,0 | 18,0 | 10 | 3,00 |
| ŚRU-12 | M12 | 50,0 | 30,0 | 22,0 | 10 | 4,57 |
| ŚRU-14 | M14 | 50,0 | 30,0 | 22,0 | 5 | 5,54 |
| ŚRU-16 | M16 | 60,0 | 35,0 | 27,0 | 5 | 7,15 |
| ŚRU-20 | M20 | 72,0 | 40,0 | 30,0 | 5 | 10,42 |
| ŚRU-24 | M24 | 90,0 | 50,0 | 38,0 | 5 | 20,54 |
| ŚRU-30 | M30 | 110,0 | 60,0 | 45,0 | 5 | 39,92 |

Nakrętka z uchem

Eye nut

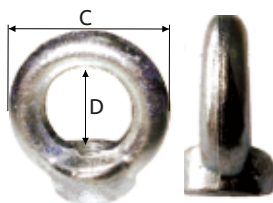

| INDEX | M | C [mm] | D [mm] | ILOŚĆ [szt.] QUANTITY [pcs] | CENA / PRICE 1 szt. / pcs [PLN] |
|---------|-----|--------|--------|--------------------------------|---------------------------------------|
| NAKU-06 | M6 | 25,0 | 14,0 | 50 | 1,83 |
| NAKU-08 | M8 | 32,6 | 20,0 | 50 | 1,86 |
| NAKU-10 | M10 | 41,0 | 25,0 | 10 | 3,00 |
| NAKU-12 | M12 | 50,0 | 30,0 | 10 | 4,57 |
| NAKU-14 | M14 | 50,0 | 30,0 | 5 | 5,54 |
| NAKU-16 | M16 | 60,0 | 35,0 | 5 | 7,15 |
| NAKU-20 | M20 | 72,0 | 40,0 | 5 | 10,42 |
| NAKU-24 | M24 | 90,0 | 50,0 | 5 | 20,54 |
| NAKU-30 | M30 | 110,0 | 60,0 | 5 | 39,92 |

Karabińczyk do lin - ocynkowany

Snap hook

DIN 5299 C

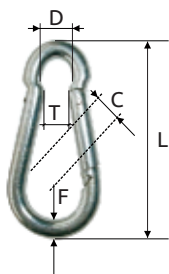

| INDEX | F [mm] | L [mm] | T [mm] | D [mm] | C [mm] | ILOŚĆ [szt.] QUANTITY [pcs] | CENA / PRICE 1 szt. / pcs [PLN] |
|--------|--------|--------|--------|--------|--------|--------------------------------|---------------------------------------|
| KAR-04 | 4,0 | 40,0 | 5,0 | 6,0 | 6,0 | 100 | 0,91 |
| KAR-05 | 5,0 | 50,0 | 6,0 | 8,0 | 7,0 | 100 | 0,95 |
| KAR-06 | 6,0 | 60,0 | 8,0 | 9,0 | 8,0 | 100 | 1,14 |
| KAR-07 | 7,0 | 70,0 | 9,0 | 10,0 | 9,0 | 50 | 1,51 |
| KAR-08 | 8,0 | 80,0 | 10,0 | 12,0 | 10,0 | 50 | 1,95 |
| KAR-09 | 9,0 | 90,0 | 11,0 | 14,0 | 13,0 | 10 | 2,68 |
| KAR-10 | 10,0 | 100,0 | 12,0 | 15,0 | 13,0 | 10 | 3,37 |
| KAR-11 | 11,0 | 120,0 | 15,0 | 18,0 | 16,0 | 10 | 4,92 |
| KAR-12 | 12,0 | 140,0 | 18,0 | 20,0 | 20,0 | 10 | 6,62 |
| KAR-13 | 13,0 | 160,0 | 20,0 | 22,0 | 27,0 | 10 | 10,65 |

Karabińczyk ozdobny - niklowany

Snap hook

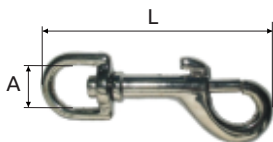

| INDEX | L [mm] | A [mm] | ILOŚĆ [szt.] QUANTITY [pcs] | CENA / PRICE 1 szt. / pcs [PLN] |
|--------|--------|--------|--------------------------------|---------------------------------------|
| KAR-53 | 53,0 | 11,0 | 100 | 1,83 |
| KAR-67 | 67,0 | 11,0 | 100 | 2,88 |
| KAR-76 | 76,0 | 14,0 | 25 | 3,83 |

Karabińczyk do lin z zabezpieczeniem - ocynkowany

Snap hook with safety screw

DIN 5299 D

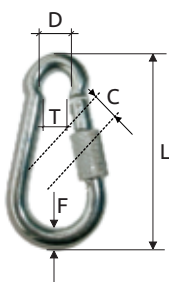

| INDEX | F [mm] | L [mm] | T [mm] | D [mm] | C [mm] | ILOŚĆ [szt.] QUANTITY [pcs] | CENA / PRICE 1 szt. / pcs [PLN] |
|---------|--------|--------|--------|--------|--------|--------------------------------|---------------------------------------|
| KARZ-04 | 4,0 | 40,0 | 5,0 | 6,0 | 6,0 | 100 | 1,22 |
| KARZ-05 | 5,0 | 50,0 | 6,0 | 8,0 | 7,0 | 50 | 1,23 |
| KARZ-06 | 6,0 | 60,0 | 8,0 | 9,0 | 8,0 | 50 | 1,42 |
| KARZ-07 | 7,0 | 70,0 | 9,0 | 10,0 | 9,0 | 50 | 1,77 |
| KARZ-08 | 8,0 | 80,0 | 10,0 | 11,0 | 10,0 | 50 | 2,18 |
| KARZ-10 | 10,0 | 100,0 | 12,0 | 15,0 | 13,0 | 25 | 3,63 |
| KARZ-11 | 11,0 | 120,0 | 15,0 | 18,0 | 16,0 | 10 | 5,31 |
| KARZ-12 | 12,0 | 140,0 | 18,0 | 20,0 | 20,0 | 10 | 7,15 |
| KARZ-13 | 13,0 | 160,0 | 20,0 | 22,0 | 27,0 | 10 | 12,63 |
| KARZ-14 | 14,0 | 180,0 | 22,0 | 25,0 | 30,0 | 10 | 17,06 |

Naciąg do siatki i drutu - ocynkowany lub zielony

Wire stretcher

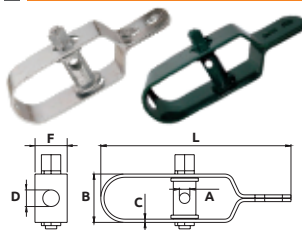

| INDEX | KOLOR COLOR | L [mm] | B [mm] | C [mm] | A [mm] | D [mm] | F [mm] | ILOŚĆ [szt.] QUANTITY [pcs] | CENA / PRICE 1 szt. / pcs [PLN] |
|----------|---------------------|-----------|-----------|-----------|-----------|-----------|-----------|--------------------------------|---------------------------------------|
| NAC-100o | L-100 ocynk/zinc | 100 | 30 | 1,5 | 7,5 | 11 | 20 | 200 | 2,46 |
| NAC-100z | L-100 zielony/green | 100 | 30 | 1,5 | 7,5 | 11 | 20 | 200 | 2,72 |
| NAC-120o | L-120 ocynk | 120 | 30 | 2,0 | 11,0 | 14 | 20 | 100 | 3,25 |
| NAC-120z | L-120 zielony | 120 | 30 | 2,0 | 11,0 | 14 | 20 | 100 | 3,68 |

Śruba naciągowa

Wire stretcher

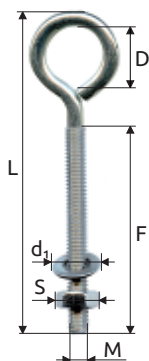

| INDEX | ROZMIAR SIZE [mm] | S [mm] | d ₁ [mm] | M [mm] | F [mm] | D [mm] | L [mm] | ILOŚĆ [szt.] QUANTITY [pcs] | CENA / PRICE 1 szt. / pcs [PLN] |
|-----------|-------------------------|-----------|------------------------|-----------|-----------|-----------|-----------|--------------------------------|---------------------------------------|
| NAC-06150 | M6 x 150 | 10 | 12 | 6 | 150 | 10,0 | 173 | 50 | 1,22 |
| NAC-08100 | M8 x 100 | 13 | 16 | 8 | 100 | 15,5 | 130 | 50 | 1,85 |
| NAC-08150 | M8 x 150 | 13 | 16 | 8 | 150 | 15,5 | 183 | 50 | 2,00 |
| NAC-08160 | M8 x 160 | 13 | 16 | 8 | 160 | 15,5 | 194 | 50 | 2,20 |
| NAC-08180 | M8 x 180 | 13 | 16 | 8 | 180 | 15,5 | 214 | 50 | 2,50 |
| NAC-08200 | M8 x 200 | 13 | 16 | 8 | 200 | 15,5 | 233 | 50 | 2,80 |
| NAC-10120 | M10 x 120 | 17 | 20 | 10 | 120 | 20,5 | 164 | 50 | 2,74 |
| NAC-10150 | M10 x 150 | 17 | 20 | 10 | 150 | 20,5 | 193 | 50 | 3,25 |
| NAC-10180 | M10 x 180 | 17 | 20 | 10 | 180 | 20,5 | 222 | 25 | 3,80 |
| NAC-10200 | M10 x 200 | 17 | 20 | 10 | 200 | 20,5 | 242 | 25 | 4,45 |

Zawlecza rolnicza - ocynk żółty

Linch pin

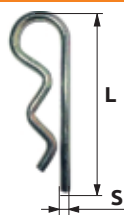

| INDEX | S [mm] | L [mm] | ILOŚĆ [szt.] QUANTITY [pcs] | CENA / PRICE 1 szt. / pcs [PLN] |
|--------|-----------|-----------|--------------------------------|---------------------------------------|
| ZAW-02 | 2,0 | 50,0 | 25 / 5000 | 0,26 |
| ZAW-03 | 3,0 | 70,0 | 25 / 1500 | 0,30 |
| ZAW-04 | 4,0 | 80,0 | 25 / 1000 | 0,51 |
| ZAW-05 | 5,0 | 100,0 | 25 / 500 | 0,82 |
| ZAW-06 | 6,0 | 110,0 | 25 / 250 | 1,31 |

Zawlecza - przetyczka rolnicza

Spring pin

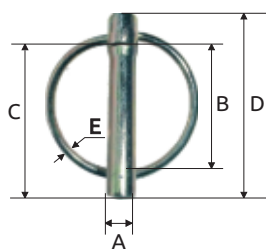

| INDEX | A [mm] | C [mm] | B [mm] | E [mm] | D [mm] | ILOŚĆ [szt.] QUANTITY [pcs] | CENA / PRICE 1 szt. / pcs [PLN] |
|--------|-----------|-----------|-----------|-----------|-----------|--------------------------------|---------------------------------------|
| ZAB-04 | 4,0 | 30,0 | 27,0 | 2,6 | 37 | 25 / 1500 | 0,64 |
| ZAB-05 | 5,0 | 45,0 | 36,5 | 3,0 | 52 | 25 / 1000 | 0,76 |
| ZAB-06 | 6,0 | 45,0 | 36,5 | 3,2 | 54 | 25 / 800 | 0,92 |
| ZAB-07 | 7,0 | 45,0 | 36,5 | 3,3 | 55 | 25 / 500 | 1,04 |
| ZAB-08 | 8,0 | 45,0 | 36,5 | 3,3 | 55 | 25 / 500 | 1,18 |
| ZAB-09 | 9,0 | 45,0 | 36,5 | 3,5 | 56 | 25 / 500 | 1,44 |
| ZAB-10 | 10,0 | 45,0 | 36,5 | 3,5 | 56 | 25 / 250 | 1,76 |
| ZAB-11 | 11,0 | 45,0 | 36,5 | 3,5 | 56 | 25 / 250 | 1,92 |

Zawlecza rozginana

Split pin

DIN94 / PN82001

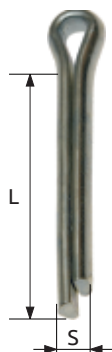

| INDEX | S [mm] | L [mm] | CENA / PRICE 1 kg [PLN] | INDEX | S [mm] | L [mm] | CENA / PRICE 1 kg [PLN] |
|-----------|-----------|-----------|-------------------------------|------------|-----------|-----------|-------------------------------|
| ZAR-02020 | 2,0 | 20 | 49,23 | ZAR-05032 | 5,0 | 32 | 31,38 |
| ZAR-02025 | 2,0 | 25 | 49,23 | ZAR-05045 | 5,0 | 45 | 31,38 |
| ZAR-02036 | 2,0 | 36 | 49,23 | ZAR-05050 | 5,0 | 50 | 31,38 |
| ZAR-02520 | 2,5 | 20 | 49,23 | ZAR-05080 | 5,0 | 80 | 31,38 |
| ZAR-02525 | 2,5 | 25 | 49,23 | ZAR-06332 | 6,3 | 32 | 31,38 |
| ZAR-02536 | 2,5 | 36 | 49,23 | ZAR-06345 | 6,3 | 45 | 31,23 |
| ZAR-03225 | 3,2 | 25 | 33,95 | ZAR-06363 | 6,3 | 63 | 31,23 |
| ZAR-03228 | 3,2 | 28 | 33,95 | ZAR-06371 | 6,3 | 71 | 31,23 |
| ZAR-03240 | 3,2 | 40 | 33,95 | ZAR-063100 | 6,3 | 100 | 31,23 |
| ZAR-03245 | 3,2 | 45 | 33,95 | ZAR-08056 | 8,0 | 56 | 32,30 |
| ZAR-04025 | 4,0 | 25 | 32,30 | ZAR-08080 | 8,0 | 80 | 32,30 |
| ZAR-04032 | 4,0 | 32 | 32,30 | ZAR-10071 | 10,0 | 71 | 32,30 |
| ZAR-04045 | 4,0 | 45 | 32,30 | ZAR-10100 | 10,0 | 100 | 32,30 |
| ZAR-04050 | 4,0 | 50 | 32,30 | | | | |

Sprężyna (spinacz) do łańcucha

Swivel snap hook

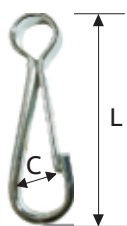

| INDEX | L [mm] | C [mm] | ILOŚĆ [szt.] QUANTITY [pcs] | CENA / PRICE 1 szt. / pcs [PLN] |
|--------|--------|--------|--------------------------------|---------------------------------------|
| SP-030 | 30,0 | 7,0 | 100 | 0,24 |
| SP-040 | 40,0 | 8,5 | 100 | 0,34 |
| SP-050 | 50,0 | 10,5 | 100 | 0,45 |
| SP-060 | 60,0 | 12,5 | 50 | 0,75 |
| SP-070 | 70,0 | 14,0 | 50 | 0,89 |
| SP-080 | 80,0 | 16,0 | 50 | 1,33 |
| SP-090 | 90,0 | 17,0 | 50 | 2,27 |

Sprężyna (spinacz) z okrętką do łańcucha

Swivel snap hook



| INDEX | L [mm] | C [mm] | ILOŚĆ [szt.] QUANTITY [pcs] | CENA / PRICE 1 szt. / pcs [PLN] |
|---------|--------|--------|--------------------------------|---------------------------------------|
| SPO-030 | 30,0 | 7,0 | 100 | 0,45 |
| SPO-040 | 40,0 | 8,5 | 100 | 0,65 |
| SPO-050 | 50,0 | 10,5 | 100 | 1,11 |
| SPO-060 | 60,0 | 12,5 | 50 | 1,34 |
| SPO-070 | 70,0 | 14,0 | 50 | 1,58 |
| SPO-080 | 80,0 | 16,0 | 50 | 2,32 |
| SPO-090 | 90,0 | 17,0 | 50 | 3,33 |
| SPO-100 | 100,0 | 18,0 | 50 | 4,42 |
| SPO-120 | 120,0 | 19,0 | 25 | 5,47 |

Krętki nikielowany

Swivel nickel plated

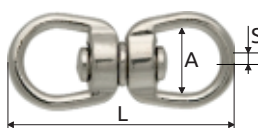

| INDEX | L [mm] | A [mm] | S [mm] | ILOŚĆ [szt.] QUANTITY [pcs] | CENA / PRICE 1 szt. / pcs [PLN] |
|---------|--------|--------|--------|--------------------------------|---------------------------------------|
| KREN-38 | 50,0 | 14,0 | 3,8 | 50 | 2,46 |
| KREN-45 | 58,0 | 12,5 | 4,5 | 50 | 3,26 |
| KREN-60 | 73,0 | 22,0 | 6,0 | 25 | 5,31 |

Okrętka super

Swivel link

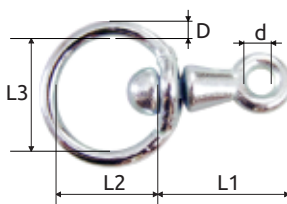

| INDEX | D [mm] | L1 [mm] | L2 [mm] | L3 [mm] | d [mm] | ILOŚĆ [szt.] QUANTITY [pcs] | CENA / PRICE 1 szt. / pcs [PLN] |
|--------|--------|---------|---------|---------|--------|--------------------------------|---------------------------------------|
| OKR-04 | 4,0 | 20,0 | 21,0 | 22,0 | 6,0 | 50 | 3,32 |
| OKR-05 | 5,0 | 40,0 | 30,0 | 33,0 | 8,0 | 50 | 3,55 |
| OKR-06 | 6,0 | 43,0 | 35,0 | 36,0 | 9,0 | 25 | 4,17 |
| OKR-07 | 7,0 | 50,0 | 37,0 | 38,0 | 9,0 | 25 | 5,40 |
| OKR-08 | 8,0 | 56,0 | 41,0 | 43,0 | 10,0 | 10 | 6,14 |
| OKR-09 | 9,0 | 56,0 | 41,0 | 43,0 | 10,0 | 10 | 8,20 |
| OKR-10 | 10,0 | 60,0 | 47,0 | 48,0 | 12,0 | 10 | 11,69 |

Tuleja aluminiowa typ A

Aluminum sleeve

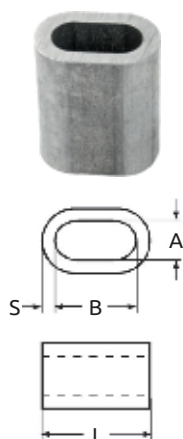

| INDEX | A [mm] | B [mm] | S [mm] | L [mm] | ILOŚĆ [szt.] QUANTITY [pcs] | CENA / PRICE 1 szt. / pcs [PLN] |
|----------|--------|--------|--------|--------|--------------------------------|---------------------------------------|
| T-TA-01 | 1,4 | 2,5 | 0,70 | 5,0 | 100 | 0,14 |
| T-TA-015 | 1,7 | 3,4 | 1,00 | 6,1 | 100 | 0,15 |
| T-TA-02 | 2,2 | 4,4 | 1,00 | 7,0 | 100 | 0,17 |
| T-TA-03 | 3,3 | 6,6 | 1,25 | 11,0 | 100 | 0,25 |
| T-TA-04 | 4,4 | 8,8 | 1,70 | 14,0 | 100 | 0,33 |
| T-TA-05 | 5,5 | 11,0 | 2,10 | 18,0 | 100 | 0,44 |
| T-TA-06 | 6,6 | 13,2 | 2,50 | 21,0 | 100 | 0,60 |
| T-TA-08 | 8,8 | 17,6 | 3,30 | 28,0 | 100 | 0,99 |
| T-TA-10 | 10,9 | 21,8 | 4,10 | 35,0 | 100 | 1,69 |
| T-TA-12 | 13,2 | 26,4 | 4,90 | 42,0 | 100 | 2,86 |
| T-TA-13 | 14,2 | 28,4 | 5,40 | 46,0 | 100 | 3,75 |
| T-TA-14 | 15,3 | 30,6 | 5,80 | 49,0 | 100 | 4,76 |
| T-TA-16 | 17,5 | 35,0 | 6,70 | 56,0 | 100 | 6,82 |

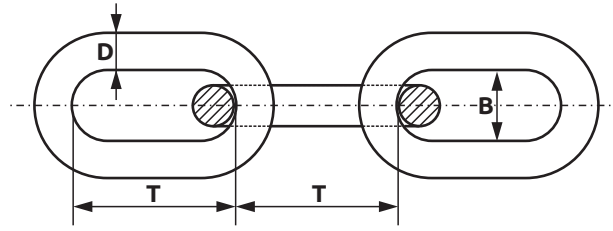

Łańcuch techniczny, ocynkowany, na rolce

Technical steel chain

DIN 5685 A



| INDEX | D [mm] | T [mm] | B _{MIN} [mm] | ILOŚĆ [mb] QUANTITY [mb] | CENA / PRICE 1 mb [PLN] |
|--------|--------|--------|-----------------------|-----------------------------|-------------------------------|
| ŁA-015 | 1,5 | 12,5 | 2,8 | 150 | 2,21 |
| ŁA-020 | 2,0 | 12,0 | 3,6 | 150 | 2,29 |
| ŁA-030 | 3,0 | 16,0 | 5,4 | 100 | 3,14 |
| ŁA-040 | 4,0 | 19,0 | 7,2 | 52 | 5,37 |
| ŁA-050 | 5,0 | 21,0 | 9,0 | 38 | 8,63 |
| ŁA-060 | 6,0 | 24,0 | 10,8 | 36 | 12,61 |
| ŁA-070 | 7,0 | 28,0 | 12,6 | 25 | 16,32 |
| ŁA-080 | 8,0 | 32,0 | 14,4 | 22 | 21,04 |
| ŁA-100 | 10,0 | 40,0 | 18,0 | 10 | 33,80 |

Łańcuch gospodarczy „D-1”, ocynkowany, na rolce (krótkie ogniwo)

Steel chain type D1

DIN 5685 A



| INDEX | D [mm] | T [mm] | B _{MIN} [mm] | ORIENTACYJNA SIŁA ZRYWAJĄCA BREAKING FORCE [KGS] | ILOŚĆ [mb] QUANTITY [mb] | CENA / PRICE 1 mb [PLN] |
|---------|--------|--------|-----------------------|---|-----------------------------|-------------------------------|
| ŁAG-015 | 1,5 | 12,5 | 2,8 | 40 | 150 | 1,77 |
| ŁAG-02 | 2,0 | 12,0 | 3,6 | 125 | 110 | 1,83 |
| ŁAG-03 | 3,0 | 16,0 | 5,4 | 280 | 60 | 2,51 |
| ŁAG-04 | 4,0 | 19,0 | 7,2 | 500 | 40 | 4,38 |
| ŁAG-05 | 5,0 | 21,0 | 9,0 | 775 | 30 | 6,90 |
| ŁAG-06 | 6,0 | 24,0 | 10,8 | 1150 | 18 | 10,09 |
| ŁAG-07 | 7,0 | 28,0 | 12,6 | 1500 | 16 | 13,06 |
| ŁAG-08 | 8,0 | 32,0 | 14,4 | 2000 | 10 | 16,85 |
| ŁAG-10 | 10,0 | 40,0 | 18,0 | 3100 | 10 | 27,05 |
| ŁAG-12 | 12,0 | 48,0 | 21,6 | 4500 | 8 | 39,83 |

Łańcuch gospodarczy „D-2”, ocynkowany, na rolce (długie ogniwo)

Steel chain type D2

DIN 5685 C



| INDEX | D [mm] | T [mm] | B _{MIN} [mm] | ORIENTACYJNA SIŁA ZRYWAJĄCA BREAKING FORCE [KGS] | ILOŚĆ [mb] QUANTITY [mb] | CENA / PRICE 1 mb [PLN] |
|---------|--------|--------|-----------------------|---|-----------------------------|-------------------------------|
| ŁAGD-02 | 2,0 | 22,0 | 3,5 | 125 | 80 | 1,74 |
| ŁAGD-03 | 3,0 | 26,0 | 5,0 | 280 | 60 | 2,40 |
| ŁAGD-04 | 4,0 | 32,0 | 7,0 | 500 | 40 | 4,17 |
| ŁAGD-05 | 5,0 | 35,0 | 9,0 | 775 | 30 | 6,55 |
| ŁAGD-06 | 6,0 | 42,0 | 11,0 | 1150 | 18 | 9,68 |
| ŁAGD-08 | 8,0 | 52,0 | 14,0 | 2000 | 10 | 16,05 |

Łańcuch gospodarczy „D-1”, ocynkowany ogniwo, na rolce (krótkie ogniwo)

Hot Dip Galvanized Chain

DIN 5685 A



| INDEX | D [mm] | T [mm] | B _{MIN} [mm] | ORIENTACYJNA SIŁA ZRYWAJĄCA BREAKING FORCE [KGS] | ILOŚĆ [mb] QUANTITY [mb] | CENA / PRICE 1 mb [PLN] |
|---------|--------|--------|-----------------------|---|-----------------------------|-------------------------------|
| ŁAGO-04 | 4,0 | 19,0 | 7,0 | 500 | 84 | 5,95 |
| ŁAGO-05 | 5,0 | 21,0 | 9,0 | 775 | 56 | 9,43 |
| ŁAGO-06 | 6,0 | 24,0 | 11,0 | 1150 | 36 | 13,81 |
| ŁAGO-08 | 8,0 | 32,0 | 14,0 | 2000 | 22 | 23,20 |
| ŁAGO-10 | 10,0 | 40,0 | 18,0 | 3100 | 14 | 37,55 |

Łańcuch plastikowy

Plastic chain



| INDEX | ROZMIAR SIZE [mm] | ILOŚĆ QUANTITY [mb] | CENA / PRICE 1 mb [PLN] |
|----------|-------------------------|----------------------------|-------------------------------|
| ŁAPL06BC | 6,0 | 25 | 5,00 |
| ŁAPL06ZC | 6,0 | 25 | 5,00 |
| ŁAPL08BC | 8,0 | 25 | 6,70 |
| ŁAPL08ZC | 8,0 | 25 | 6,70 |

Łańcuch węzłowy „Viktor” w wiązce lub na rolce

VICTOR nodal chain

DIN 5686



| INDEX | D [mm] | ILOŚĆ / QUANTITY [mb] | | CENA / PRICE | |
|--------|-----------|--------------------------|---------------|------------------------|----------------------|
| | | WIĄZKA BUNDLE | ROLKA ROLL | 1 mb (bundle) [PLN] | 1 mb (roll) [PLN] |
| ŁAV-14 | 1,4 | 30 | 150 | 1,46 | 1,49 |
| ŁAV-16 | 1,6 | 30 | 130 | 1,75 | 1,80 |
| ŁAV-18 | 1,8 | 30 | 130 | 1,97 | 2,01 |
| ŁAV-20 | 2,0 | 30 | 118 | 2,31 | 2,35 |
| ŁAV-22 | 2,2 | 30 | 118 | 2,35 | 2,55 |
| ŁAV-25 | 2,5 | 30 | 70 | 3,07 | 3,12 |
| ŁAV-28 | 2,8 | 30 | 66 | 3,51 | - |
| ŁAV-30 | 3,0 | 30 | 40 | 3,85 | 4,27 |
| ŁAV-38 | 3,8 | 30 | - | 5,07 | - |
| ŁAV-46 | 4,6 | 30 | 30 | 7,09 | 7,87 |

Łańcuszek niezgrzewany, ocynkowany

Zinc-plated steel chain



| INDEX | D [mm] | T [mm] | B _{MIN} [mm] | ILOŚĆ W WIĄZCE QUANTITY BUNDLE [mb] | CENA / PRICE 1 mb [PLN] |
|---------|-----------|-----------|--------------------------|---|-------------------------------|
| ŁAN-012 | 1,2 | 10,0 | 4,0 | 50 | 4,10 |
| ŁAN-014 | 1,4 | 11,0 | 4,0 | 50 | 4,02 |
| ŁAN-016 | 1,6 | 13,0 | 4,0 | 50 | 3,95 |
| ŁAN-018 | 1,8 | 15,0 | 5,0 | 50 | 3,87 |
| ŁAN-020 | 2,0 | 20,0 | 6,0 | 50 | 3,79 |
| ŁAN-022 | 2,2 | 25,0 | 6,0 | 50 | 3,72 |
| ŁAN-025 | 2,5 | 22,0 | 9,0 | 50 | 3,72 |

Łańcuch spinający

Spanning chain



| INDEX | D [mm] | DŁUGOŚĆ LENGTH [cm] | Ø [mm] | ILOŚĆ W WIĄZCE QUANTITY BUNDLE [mb] | CENA / PRICE 1 mb [PLN] |
|----------|-----------|---------------------------|-----------|---|-------------------------------|
| ŁASP-030 | 3,0 | 50 | 19 | 25 | 5,84 |
| ŁASP-040 | 4,0 | 50 | 19 | 25 | 7,74 |
| ŁASP-050 | 5,0 | 50 | 25 | 25 | 10,23 |

Łańcuch gospodarczy (pastwiskowy), ocynkowany

Grazing steel chain



| INDEX | D [mm] | DŁUGOŚĆ LENGTH [mb] | ILOŚĆ [szt.] QUANTITY [pcs] | | CENA / PRICE 1 szt./ pcs [PLN] |
|---------|-----------|---------------------------|--------------------------------|--|--------------------------------------|
| ŁAPA-40 | 4,0 | 5,0 | | | 35,90 |

Łańcuch gospodarczy (żłobowy)

Black manger chain

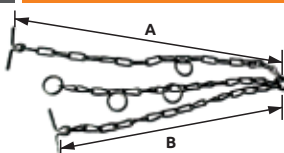

| INDEX | D [mm] | A [mm] | B [mm] | ILOŚĆ [szt.] QUANTITY [pcs] | | CENA / PRICE 1 szt./ pcs [PLN] |
|---------|-----------|-----------|-----------|--------------------------------|----|--------------------------------------|
| ŁAŻ-040 | 4,0 | 80 | 56 | | | 18,20 |
| ŁAŻ-050 | 5,0 | 80 | 56 | 1 | 20 | 24,10 |

Elektroda RC STANDARD / Welding electrode RC STANDARD



| INDEX | ROZMIAR SIZE [mm] | WAGA WEIGHT [kg] | CENA / PRICE 1 kg [PLN] |
|---------------|----------------------|---------------------|----------------------------|
| EL-S25/350MON | 2,5 x 350 | 2,5 | 18,04 |
| EL-S32/350MON | 3,2 x 350 | 2,5 | 17,80 |
| EL-S40/450MON | 4,0 x 450 | 5,0 | 17,54 |

Elektroda RC INDUSTRY / Welding electrode RC INDUSTRY



| INDEX | ROZMIAR SIZE [mm] | WAGA WEIGHT [kg] | CENA / PRICE 1 kg [PLN] |
|---------------|----------------------|---------------------|----------------------------|
| EL-I20/300MON | 2,0 x 300 | 1,0 | 22,85 |
| EL-I25/350MON | 2,5 x 350 | 2,5 | 21,03 |
| EL-I32/350MON | 3,2 x 350 | 2,5 | 19,79 |
| EL-I40/450MON | 4,0 x 450 | 5,0 | 18,56 |

Elektroda zasadowa PLASMA / Welding electrode PLASMA



| INDEX | ROZMIAR SIZE [mm] | WAGA WEIGHT [kg] | CENA / PRICE 1 kg [PLN] |
|---------------|----------------------|---------------------|----------------------------|
| EL-Z25/350MON | 2,5 x 350 | 2,5 | 21,49 |
| EL-Z32/350MON | 3,2 x 350 | 2,5 | 21,00 |

Elektroda do INOX / Welding electrode INOX



| INDEX | ROZMIAR SIZE [mm] | WAGA WEIGHT [kg] | CENA / PRICE 1 kg [PLN] |
|----------------|----------------------|---------------------|----------------------------|
| EL-IN25/350MON | 2,5 x 350 | 1,0 | 96,15 |
| EL-IN32/350MON | 3,2 x 350 | 1,0 | 96,15 |



Drut spawalniczy SG2 / Welding wire SG2



| INDEX | RODZAJ TYPE | ŚREDNICA DIAMETER [mm] | WAGA WEIGHT [kg] | CENA / PRICE 1 kg [PLN] |
|-------------|----------------|---------------------------|---------------------|----------------------------|
| DR-08/05Mon | G3Si1 | 0,8 | 5,0 | 18,02 |
| DR-08/15Mon | G3Si1 | 0,8 | 15,0 | 15,82 |
| DR-10/15Mon | G3Si1 | 1,0 | 15,0 | 15,71 |
| DR-12/15Mon | G3Si1 | 1,2 | 15,0 | 15,49 |

Drut spawalniczy EBD SG2 / Welding wire EBD SG2



| INDEX | RODZAJ TYPE | ŚREDNICA DIAMETER [mm] | WAGA WEIGHT [kg] | CENA / PRICE 1 kg [PLN] |
|----------------|----------------|---------------------------|---------------------|----------------------------|
| DRS0605 | TYS WELD | 0,6 | 5,0 | 26,37 |
| DRS082 | TYS WELD | 0,8 | 15,0 | 19,64 |
| DRS085 | TYS WELD | 0,8 | 5,0 | 20,02 |
| DRS10 | TYS WELD | 1,0 | 15,0 | 18,05 |
| DRS12 | TYS WELD | 1,2 | 18,0 | 17,22 |
| DRS16 | TYS WELD | 1,6 | 15,0 | 16,92 |

Elektroda ER 146 / Welding electrode ER 146



Średniootulona elektroda rutyłowa do spawania stali niskostopowych (niskowęglowych) we wszystkich zalecanych pozycjach. Zalecana do prac montażowych.

| INDEX | ROZMIAR SIZE [mm] | WAGA WEIGHT [kg] | CENA / PRICE 1 kg [PLN] |
|--------------------|----------------------|---------------------|----------------------------|
| ELER-20300 | 2,0 x 300 | 4,7 | 40,20 |
| ELER-25350 | 2,5 x 350 | 5,0 | 34,46 |
| ELER-325450 | 3,25 x 450 | 6,5 | 29,77 |
| ELER-40450 | 4,0 x 450 | 6,5 | 29,69 |
| ELER-50450 | 5,0 x 450 | 6,0 | 29,12 |

Elektroda ER 150 / Welding electrode ER 150



Średniootulona elektroda rutyłowa do spawania stali niskostopowych (niskowęglowych) we wszystkich zalecanych pozycjach. Zalecana do prac montażowych.

| INDEX | ROZMIAR SIZE [mm] | WAGA WEIGHT [kg] | CENA / PRICE 1 kg [PLN] |
|--------------------|----------------------|---------------------|----------------------------|
| ELEB-25350 | 2,5 x 350 | 5,0 | 36,70 |
| ELEB-325350 | 3,25 x 350 | 5,0 | 32,44 |
| ELEB-40450 | 4,00 x 450 | 5,0 | 31,34 |

Elektroda OVERCORD E / Welding electrode OVERCORD E



OVERCORD E jest elektrodą do spawania we wszystkich pozycjach, szczególnie z góry na dół. Zalecana do prac montażowych w przemyśle maszynowym i okrętowym. Przeznaczona do spawania stali niskowęglowych i niskostopowych.

| INDEX | ROZMIAR SIZE [mm] | WAGA WEIGHT [kg] | CENA / PRICE 1 kg [PLN] |
|-------------------|----------------------|---------------------|----------------------------|
| ELO-20300 | 2,0 x 300 | 1,9 | 53,97 |
| ELO-25350 | 2,5 x 350 | 4,5 | 34,46 |
| ELO-325350 | 3,25 x 350 | 4,5 | 29,77 |
| ELO-40350 | 4,0 x 350 | 4,5 | 29,77 |

Elektroda RUTILEN 12 350mm / Welding electrode RUTILEN 12



Uniwersalna elektroda do spawania konstrukcji stalowych szczególnie małogabarytowych i o cienkich ściankach. Polecana do spawania w pozycjach przymusowych w tym góra - dół. Stosowana w urządzeniach o niskim napięciu zajarzania $u > 50V$.

| INDEX | ROZMIAR SIZE [mm] | WAGA WEIGHT [kg] | CENA / PRICE 1 kg [PLN] |
|----------------------|----------------------|---------------------|----------------------------|
| ELR-12253501 | 2,5 x 350 | 1,0 | 43,40 |
| ELR-12253505 | 2,5 x 350 | 5,0 | 31,56 |
| ELR-123253501 | 3,25 x 350 | 1,0 | 38,90 |
| ELR-123253505 | 3,25 x 350 | 5,0 | 28,94 |
| ELR-12403501 | 4,0 x 450 | 1,0 | 31,55 |
| ELR-12403505 | 4,0 x 350 | 5,0 | 28,59 |

Elektroda INOX 308L / Welding electrode INOX 308L



Elektroda grubo otulona rutyłowa INOX 308L do spawania stali nierdzewnych, kwasoodpornych i chromo - niklowych. Używana do spawania stali austenitycznej, odporna na korozję.

| INDEX | ROZMIAR SIZE [mm] | WAGA WEIGHT [kg] | CENA / PRICE 1 kg [PLN] |
|-------------------|----------------------|---------------------|----------------------------|
| EL701-INOX | 2,0 x 300 | 1,3 | 123,60 |
| EL702-INOX | 2,5 x 300 | 1,4 | 121,91 |
| EL705-INOX | 3,25 x 350 | 1,7 | 119,51 |

Hak grzejnikowy, kątowy - stalowy, ocynkowany i lakierowany / Galvanized bent radiator hook



| INDEX | RODZAJ TYPE | CENA / PRICE 1 szt./pcs [PLN] |
|---------|-------------------------|------------------------------------|
| HGK-01 | ocynk / zinc | 4,30 |
| HGKM-01 | lakierowany / lacquered | 4,30 |

Hak grzejnikowy - stalowy, ocynkowany i lakierowany / Galvanized radiator hook long



| INDEX | RODZAJ TYPE | CENA / PRICE 1 szt./pcs [PLN] |
|--------|-------------------------|------------------------------------|
| HG-01 | ocynk / zinc | 3,60 |
| HGM-01 | lakierowany / lacquered | 3,60 |

Uchwyt do rur podwójny - stalowy, ocynkowany Double pipe clamp



| INDEX | ROZMIAR SIZE [cal] | ROZMIAR SIZE [mm] | CENA / PRICE 1 szt./pcs [PLN] |
|-------|-----------------------|----------------------|---------------------------------------|
| UP-38 | 3/8 | 15-18 | 4,86 |
| UP-12 | 1/2 | 20-23 | 5,05 |
| UP-34 | 3/4 | 26-29 | 5,32 |
| UP-1 | 1 | 32-36 | 5,88 |

Uchwyt do rur podwójny z uszczelką gumową - stalowy, ocynk Double pipe clamp with gasket



| INDEX | ROZMIAR SIZE [cal] | ROZMIAR SIZE [mm] | CENA / PRICE 1 szt./pcs [PLN] |
|--------|-----------------------|----------------------|---------------------------------------|
| UPT-38 | 3/8 | 15-18 | 5,05 |
| UPT-12 | 1/2 | 20-23 | 5,48 |
| UPT-34 | 3/4 | 26-29 | 5,88 |
| UPT-1 | 1 | 32-36 | 6,37 |

Uchwyt do rur - stalowy, ocynkowany Pipe clamp



| INDEX | ROZMIAR SIZE [cal] | ROZMIAR SIZE [mm] | ILOŚĆ [szt.] QUANTITY [pcs] | CENA / PRICE 1 szt./pcs [PLN] |
|-------|-----------------------|----------------------|--------------------------------|---------------------------------------|
| U-38 | 3/8 | 15-18 | 100 | 2,20 |
| U-12 | 1/2 | 20-23 | 100 | 2,23 |
| U-34 | 3/4 | 26-29 | 100 | 2,37 |
| U-1 | 1 | 32-36 | 100 | 2,59 |
| U-54 | 5/4 | 40-43 | 100 | 3,05 |
| U-64 | 6/4 | 48-51 | 100 | 3,27 |
| U-2 | 2 | 58-62 | 100 | 4,20 |
| U-212 | 2 1/2 | 75-80 | 100 | 5,42 |
| U-3 | 3 | 88-92 | 50 | 5,91 |
| U-4 | 4 | 106-110 | 50 | 6,58 |
| U-5 | 5 | 128-134 | 45 | 7,69 |
| U-6 | 6 | 155-160 | 35 | 9,20 |
| U-8 | 8 | 195-205 | 25 | 16,00 |

Uchwyt do rur z uszczelką gumową - stalowy, ocynk Pipe clamp with gasket



| INDEX | ROZMIAR SIZE [cal] | ROZMIAR SIZE [mm] | ILOŚĆ [szt.] QUANTITY [pcs] | CENA / PRICE 1 szt./pcs [PLN] |
|--------|-----------------------|----------------------|--------------------------------|---------------------------------------|
| UT-38 | 3/8 | 15-18 | 100 | 2,51 |
| UT-12 | 1/2 | 20-23 | 100 | 2,54 |
| UT-34 | 3/4 | 26-29 | 100 | 2,65 |
| UT-1 | 1 | 32-36 | 100 | 2,91 |
| UT-54 | 5/4 | 40-43 | 100 | 3,27 |
| UT-64 | 6/4 | 48-51 | 100 | 3,61 |
| UT-2 | 2 | 58-62 | 100 | 4,35 |
| UT-212 | 2 1/2 | 75-80 | 80 | 5,35 |
| UT-3 | 3 | 88-92 | 60 | 6,03 |
| UT-4 | 4 | 106-110 | 50 | 7,72 |
| UT-5 | 5 | 128-134 | 35 | 9,51 |
| UT-6 | 6 | 155-160 | 30 | 10,86 |
| UT-8 | 8 | 195-205 | 20 | 21,02 |

Taśma SERRATUB W2 9mm Hose Clamp Roll



| INDEX | RODZAJ TYPE | CENA / PRICE 1 szt./pcs [PLN] |
|-------|-------------------------|------------------------------------|
| TAŚ | Taśma W2 9mm / 30m | 210,60 |
| ZAMEK | Zamek do taśmy SERRATUB | 4,36 |

Opaska ślimakowa „K-2”

GM (GERMAN MIDDLE) type hose clamp



| OCYNKOWANA / ZINC | | | |
|-------------------|------------------------------------|-----------------------------|---------------------------------|
| INDEX | ZAKRES PRACY OPERATING RANGES [mm] | ILOŚĆ [szt.] QUANTITY [pcs] | CENA / PRICE 1 szt. / pcs [PLN] |
| OBI-00711 | 7-11 | 50 | 0,75 |
| OBI-00812 | 8-12 | 50 | 0,77 |
| OBI-01016 | 10-16 | 50 | 0,79 |
| OBI-01222 | 12-22 | 50 | 0,89 |
| OBI-01320 | 13-20 | 50 | 0,91 |
| OBI-01627 | 16-27 | 50 | 0,92 |
| OBI-02032 | 20-32 | 50 | 0,94 |
| OBI-02540 | 25-40 | 50 | 0,97 |
| OBI-03045 | 30-45 | 50 | 1,01 |
| OBI-03850 | 38-50 | 50 | 1,04 |
| OBI-04060 | 40-60 | 50 | 1,11 |
| OBI-05070 | 50-70 | 50 | 1,18 |
| OBI-06080 | 60-80 | 25 | 1,25 |
| OBI-06885 | 68-85 | 25 | 1,32 |
| OBI-080100 | 80-100 | 25 | 1,47 |
| OBI-087112 | 87-112 | 25 | 1,54 |
| OBI-100125 | 100-125 | 25 | 2,08 |
| OBI-120140 | 120-140 | 25 | 2,12 |
| OBI-130165 | 130-165 | 10 | 2,43 |
| OBI-150180 | 150-180 | 10 | 2,61 |
| OBI-170190 | 170-190 | 5 | 2,87 |
| OBI-180200 | 180-200 | 5 | 2,97 |
| OBI-190210 | 190-210 | 5 | 3,12 |
| OBI-200220 | 200-220 | 5 | 3,23 |
| OBI-210230 | 210-230 | 5 | 3,44 |
| OBI-220240 | 220-240 | 5 | 3,59 |
| OBI-230200 | 230-250 | 5 | 3,95 |
| OBI-240260 | 240-260 | 5 | 4,05 |



| STAL NIERDZEWNA / STAINLESS STEEL | | | |
|-----------------------------------|------------------------------------|-----------------------------|---------------------------------|
| INDEX | ZAKRES PRACY OPERATING RANGES [mm] | ILOŚĆ [szt.] QUANTITY [pcs] | CENA / PRICE 1 szt. / pcs [PLN] |
| OBN-00711 | 7-11 | 50 | 2,14 |
| OBN-00812 | 8-12 | 50 | 2,15 |
| OBN-01016 | 10-16 | 50 | 2,17 |
| OBN-01222 | 12-22 | 50 | 2,22 |
| OBN-01320 | 13-20 | 50 | 2,24 |
| OBN-01627 | 16-27 | 50 | 2,27 |
| OBN-02032 | 20-32 | 50 | 2,36 |
| OBN-02540 | 25-40 | 50 | 2,63 |
| OBN-03045 | 30-45 | 50 | 2,72 |
| OBN-03850 | 38-50 | 50 | 2,77 |
| OBN-04060 | 40-60 | 50 | 2,91 |
| OBN-05070 | 50-70 | 50 | 3,63 |
| OBN-06080 | 60-80 | 25 | 3,81 |
| OBN-06885 | 68-85 | 25 | 3,94 |
| OBN-080100 | 80-100 | 25 | 4,02 |
| OBN-087112 | 87-112 | 25 | 4,10 |
| OBN-100125 | 100-125 | 25 | 4,46 |
| OBN-120140 | 120-140 | 25 | 4,63 |
| OBN-130165 | 130-165 | 10 | 5,00 |
| OBN-150180 | 150-180 | 10 | 5,35 |

ZASTOSOWANIE: instalacje wodne, gazowe, paliwowe, wentylacje

Na zamówienie realizujemy kwasoodporne obejmy ślimakowe i wszelkie obejmy dla branży motoryzacyjnej.

Opaska GBS - ocynkowana

GBS pipe clamp



| INDEX | ZAKRES PRACY OPERATING RANGES [mm] | ILOŚĆ [szt.] QUANTITY [pcs] | | CENA / PRICE 1 szt. / pcs [PLN] |
|---------|------------------------------------|-----------------------------|-----|---------------------------------|
| | | | | |
| OBB-02 | 17-19 | 50 | 400 | 2,91 |
| OBB-022 | 19-21 | 50 | 400 | 2,92 |
| OBB-03 | 21-23 | 50 | 400 | 2,94 |
| OBB-04 | 23-25 | 50 | 400 | 2,97 |
| OBB-06 | 25-27 | 50 | 400 | 3,01 |
| OBB-07 | 27-29 | 50 | 300 | 3,22 |
| OBB-08 | 29-31 | 50 | 300 | 3,54 |
| OBB-10 | 31-34 | 50 | 300 | 3,57 |
| OBB-11 | 34-37 | 50 | 300 | 3,62 |
| OBB-12 | 37-40 | 50 | 300 | 3,68 |
| OBB-14 | 40-43 | 50 | 300 | 3,73 |
| OBB-15 | 43-47 | 50 | 200 | 4,91 |
| OBB-16 | 48-51 | 50 | 200 | 4,94 |
| OBB-18 | 51-55 | 50 | 200 | 5,09 |
| OBB-20 | 55-59 | 50 | 200 | 5,16 |
| OBB-22 | 59-63 | 50 | 200 | 5,32 |
| OBB-24 | 63-69 | 50 | 200 | 5,50 |
| OBB-26 | 68-73 | 25 | 100 | 7,28 |
| OBB-28 | 73-79 | 25 | 100 | 7,62 |
| OBB-30 | 79-85 | 25 | 100 | 7,85 |
| OBB-31 | 85-91 | 25 | 100 | 8,03 |
| OBB-32 | 91-97 | 25 | 100 | 8,26 |
| OBB-34 | 97-104 | 25 | 100 | 8,55 |
| OBB-35 | 104-112 | 25 | 100 | 8,77 |
| OBB-36 | 112-121 | 25 | 100 | 9,08 |
| OBB-38 | 121-130 | 25 | 100 | 9,40 |
| OBB-40 | 130-140 | 10 | 50 | 14,43 |
| OBB-42 | 140-150 | 10 | 50 | 14,79 |
| OBB-44 | 150-162 | 10 | 50 | 15,35 |
| OBB-46 | 162-174 | 10 | 50 | 16,24 |
| OBB-48 | 174-187 | 10 | 50 | 17,09 |
| OBB-50 | 187-200 | 5 | 25 | 17,76 |
| OBB-52 | 201-213 | 5 | 25 | 18,39 |
| OBB-54 | 214-226 | 5 | 25 | 19,05 |

Cybant ocynkowany

U-bolt



| INDEX | ROZMIAR SIZE [mm] | ŚR. MOCOWANIA DIAMETER OF FIXING [mm] | ILOŚĆ [szt.] QUANTITY [pcs] | CENA / PRICE 1 szt. / pcs [PLN] |
|------------|----------------------|---|--------------------------------|---------------------------------------|
| CYBB-06011 | M6 x 11 | 1/8" | 20 | 3,91 |
| CYBB-06014 | M6 x 14 | 1/4" | 20 | 3,93 |
| CYBB-06018 | M6 x 18 | 3/8" | 20 | 3,95 |
| CYBB-06023 | M6 x 23 | 1/2" | 20 | 2,64 |
| CYBB-06028 | M6 x 28 | 3/4" | 20 | 2,70 |
| CYBB-06035 | M6 x 35 | 1" | 20 | 2,75 |
| CYBB-06043 | M6 x 43 | 1 1/4" | 20 | 2,81 |
| CYBB-06049 | M6 x 49 | 1 1/2" | 20 | 2,97 |
| CYBB-08023 | M8 x 23 | 1/2" | 20 | 2,24 |
| CYBB-08028 | M8 x 28 | 3/4" | 20 | 2,31 |
| CYBB-08035 | M8 x 35 | 1" | 20 | 2,39 |
| CYBB-08043 | M8 x 43 | 1 1/4" | 20 | 2,68 |
| CYBB-08049 | M8 x 49 | 1 1/2" | 20 | 2,86 |
| CYBB-08061 | M8 x 61 | 2" | 20 | 3,80 |
| CYBB-08077 | M8 x 77 | 2 1/2" | 20 | 4,11 |
| CYBB-08089 | M8 x 89 | 3" | 20 | 5,05 |
| CYBB-08115 | M8 x 115 | 4" | 20 | 5,38 |
| CYBB-10035 | M10 x 35 | 1" | 20 | 3,87 |
| CYBB-10043 | M10 x 43 | 1 1/4" | 20 | 4,18 |
| CYBB-10049 | M10 x 49 | 1 1/2" | 20 | 4,33 |
| CYBB-10061 | M10 x 61 | 2" | 20 | 4,90 |
| CYBB-10077 | M10 x 77 | 2 1/2" | 20 | 7,30 |
| CYBB-10089 | M10 x 89 | 3" | 20 | 7,80 |

Łącznik do cybantów ocynkowany

U-bolt connector



| INDEX | ROZMIAR SIZE [mm] | PRZEZNACZENIE DESTINY | ILOŚĆ [szt.] QUANTITY [pcs] | CENA / PRICE 1 szt. / pcs [PLN] |
|------------|----------------------|--------------------------|--------------------------------|---------------------------------------|
| CYBŁ-06023 | ø6,4 x 23 | M6 (1/2") | 20 | 3,21 |
| CYBŁ-06028 | ø6,4 x 28 | M6 (3/4") | 20 | 3,49 |
| CYBŁ-06035 | ø6,4 x 35 | M6 (1") | 20 | 3,60 |
| CYBŁ-06043 | ø6,4 x 43 | M6 (1 1/4") | 20 | 4,15 |
| CYBŁ-06049 | ø6,4 x 49 | M6 (1 1/2") | 20 | 4,48 |
| CYBŁ-08023 | ø8,4 x 23 | M8 (1/2") | 20 | 3,21 |
| CYBŁ-08028 | ø8,4 x 28 | M8 (3/4") | 20 | 3,49 |
| CYBŁ-08035 | ø8,4 x 35 | M8 (1") | 20 | 3,60 |
| CYBŁ-08043 | ø8,4 x 43 | M8 (1 1/4") | 20 | 4,13 |
| CYBŁ-08049 | ø8,4 x 49 | M8 (1 1/2") | 20 | 4,48 |
| CYBŁ-08061 | ø8,4 x 61 | M8 (2") | 20 | 5,38 |
| CYBŁ-10035 | ø10,5 x 35 | M10 (1") | 20 | 4,18 |
| CYBŁ-10043 | ø10,5 x 43 | M10 (1 1/4") | 20 | 4,70 |
| CYBŁ-10049 | ø10,5 x 49 | M10 (1 1/2") | 20 | 4,48 |
| CYBŁ-10061 | ø10,5 x 61 | M10 (2") | 20 | 5,38 |
| CYBŁ-10077 | ø10,5 x 77 | M10 (2 1/2") | 20 | 6,64 |
| CYBŁ-10089 | ø10,5 x 89 | M10 (3") | 20 | 7,96 |
| CYBŁ-10115 | ø10,5 x 115 | M10 (4") | 20 | 11,20 |

Taśma montażowa

Perforated tape



| INDEX | SZEROKOŚĆ WIDTH [mm] | GRUBOŚĆ THICKNESS [mm] | DŁUGOŚĆ LENGHT [M.] | ŚR. OTWORU DIAMETER [mm] | CENA / PRICE 1 szt. / pcs [PLN] |
|---------|-------------------------|---------------------------|------------------------|-----------------------------|---------------------------------------|
| TBANW12 | 12 | 0,7 | 10 | 5 | 63,40 |
| TBANW17 | 17 | 0,7 | 10 | 7 | 71,40 |

Złącze kątowe

Strengthening angle

ETA-06-0106-2

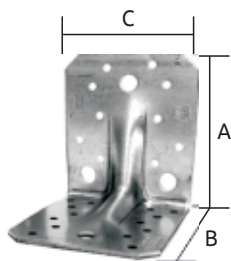

| INDEX | RODZAJ TYPE | A [mm] | B [mm] | C [mm] | ≠ [mm] | WAGA 1 SZT. WEIGHT 1 PCS [kg] | ILOŚĆ [szt.] QUANTITY [pcs] | CENA / PRICE 1 szt. / pcs [PLN] |
|-------------|-------------|--------|--------|--------|--------|-------------------------------|-----------------------------|---------------------------------|
| ZŁKA-7070 | 70 wzm | 70 | 70 | 55 | 2,0 | 0,11 | 100 | 3,81 |
| ZŁKA-7071 | 70 | 70 | 70 | 55 | 2,0 | 0,11 | 100 | 3,70 |
| ZŁKA-7090 | 90 wzm | 90 | 90 | 65 | 2,0 | 0,21 | 50 | 4,16 |
| ZŁKA-709025 | 90 wzm | 90 | 90 | 65 | 2,5 | 0,22 | 50 | 4,97 |
| ZŁKA-7091 | 90 | 90 | 90 | 65 | 2,5 | 0,20 | 100 | 4,97 |
| ZŁKA-7105 | 105 wzm | 105 | 105 | 90 | 3,0 | 0,40 | 50 | 8,47 |
| ZŁKA-7105-2 | 105 wzm | 105 | 105 | 90 | 2,0 | 0,30 | 50 | 6,47 |
| ZŁKA-7106 | 105 | 105 | 105 | 90 | 3,0 | 0,40 | 50 | 7,97 |

Złącze kątowe 90x48x3,0x...

Strengthening angle

ETA-06-0106-2

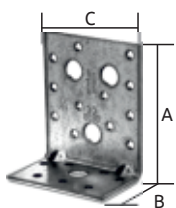

| INDEX | RODZAJ TYPE | A [mm] | B [mm] | C [mm] | ≠ [mm] | WAGA 1 SZT. WEIGHT 1 PCS [kg] | ILOŚĆ [szt.] QUANTITY [pcs] | CENA / PRICE 1 szt. / pcs [PLN] |
|-----------|---------------|--------|--------|--------|--------|-------------------------------|-----------------------------|---------------------------------|
| ZŁKA-7048 | 90x48x3,0x48 | 90 | 48 | 48 | 3,0 | 0,13 | 100 | 6,47 |
| ZŁKA-7076 | 90x48x3,0x76 | 90 | 48 | 76 | 3,0 | 0,21 | 100 | 9,59 |
| ZŁKA-7116 | 90x48x3,0x116 | 90 | 48 | 116 | 3,0 | 0,34 | 50 | 14,56 |

Złącze kątowe 60280

Strengthening angle

ETA-06-0106-2

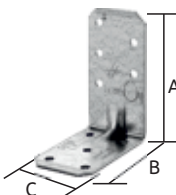

| INDEX | RODZAJ TYPE | A [mm] | B [mm] | C [mm] | ≠ [mm] | WAGA 1 SZT. WEIGHT 1 PCS [kg] | ILOŚĆ [szt.] QUANTITY [pcs] | CENA / PRICE 1 szt. / pcs [PLN] |
|-----------|-------------|--------|--------|--------|--------|-------------------------------|-----------------------------|---------------------------------|
| ZŁKA-7680 | 60280 | 83 | 62 | 40 | 2,0 | 0,08 | 100 | 3,47 |

Złącze kątowe 6090-6191

Strengthening angle

ETA-06-0106-2

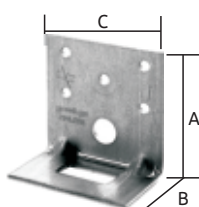

| INDEX | RODZAJ TYPE | A [mm] | B [mm] | C [mm] | ≠ [mm] | WAGA 1 SZT. WEIGHT 1 PCS [kg] | ILOŚĆ [szt.] QUANTITY [pcs] | CENA / PRICE 1 szt. / pcs [PLN] |
|-----------|-------------|--------|--------|--------|--------|-------------------------------|-----------------------------|---------------------------------|
| ZŁKA-7690 | 6090 | 90 | 60 | 60 | 2,5 | 0,16 | 100 | 7,28 |

Złącze kątowe 40390

Connection angle

ETA-06-0106-2

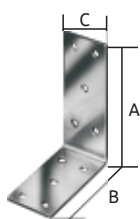

| INDEX | RODZAJ TYPE | A [mm] | B [mm] | C [mm] | ≠ [mm] | WAGA 1 SZT. WEIGHT 1 PCS [kg] | ILOŚĆ [szt.] QUANTITY [pcs] | CENA / PRICE 1 szt. / pcs [PLN] |
|-----------|-------------|--------|--------|--------|--------|-------------------------------|-----------------------------|---------------------------------|
| ZŁKA-7390 | 40390 | 93 | 93 | 40 | 3,0 | 0,16 | 100 | 4,97 |

Złącze kątowe 40312-40412

Connection angle

ETA-06-0106-2

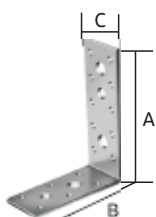

| INDEX | RODZAJ TYPE | A [mm] | B [mm] | C [mm] | ≠ [mm] | WAGA 1 SZT. WEIGHT 1 PCS [kg] | ILOŚĆ [szt.] QUANTITY [pcs] | CENA / PRICE 1 szt. / pcs [PLN] |
|-----------|-------------|--------|--------|--------|--------|-------------------------------|-----------------------------|---------------------------------|
| ZŁKA-7312 | 40312 | 119 | 91 | 40 | 3,0 | 0,18 | 100 | 7,39 |
| ZŁKA-7412 | 40412 | 120 | 92 | 40 | 4,0 | 0,24 | 100 | 9,24 |

Kątownik wąski Narrow angle

ETA-06-0106-2

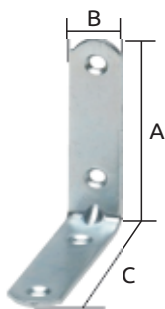

| INDEX | RODZAJ TYPE | A [mm] | B [mm] | C [mm] | ≠ [mm] | WAGA 1 SZT. WEIGHT 1 PCS [kg] | ILOŚĆ [szt.] QUANTITY [pcs] | CENA / PRICE 1 szt. / pcs [PLN] |
|-----------|----------------|-----------|-----------|-----------|-----------|-------------------------------------|--------------------------------|---------------------------------------|
| ZŁKA-0302 | SEC 30/2 | 30 | 15 | 30 | 2,0 | 0,01 | 500 | 1,62 |
| ZŁKA-0402 | SEC 40/2 | 40 | 15 | 40 | 2,0 | 0,02 | 500 | 1,73 |
| ZŁKA-0602 | SEC 60/2 | 60 | 15 | 60 | 2,0 | 0,03 | 500 | 2,19 |
| ZŁKA-0802 | SEC 80/2 | 80 | 15 | 80 | 2,5 | 0,05 | 200 | 3,00 |
| ZŁKA-1003 | SEC100/3 | 100 | 18 | 100 | 3,0 | 0,08 | 200 | 8,66 |
| ZŁKA-1203 | SEC120/3 | 120 | 18 | 120 | 3,0 | 0,10 | 200 | 9,47 |
| ZŁKA-1403 | SEC140/3 | 140 | 18 | 140 | 3,0 | 0,12 | 200 | 12,36 |

Złącze kątowe 35350-55365 Connection angle

ETA-06-0106-2

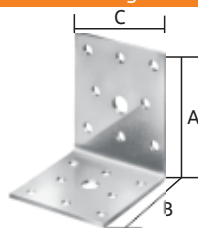

| INDEX | RODZAJ TYPE | A [mm] | B [mm] | C [mm] | ≠ [mm] | WAGA 1 SZT. WEIGHT 1 PCS [kg] | ILOŚĆ [szt.] QUANTITY [pcs] | CENA / PRICE 1 szt. / pcs [PLN] |
|-----------|----------------|-----------|-----------|-----------|-----------|-------------------------------------|--------------------------------|---------------------------------------|
| ZŁKA-7350 | 35350 | 50 | 50 | 35 | 2,0 | 0,06 | 100 | 3,00 |
| ZŁKA-7365 | 55365 | 65 | 65 | 55 | 2,5 | 0,15 | 100 | 5,31 |

Złącze kątowe Connection angle

ETA-06-0106-2

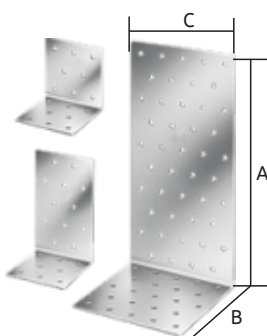

| INDEX | RODZAJ TYPE | A [mm] | B [mm] | C [mm] | ≠ [mm] | WAGA 1 SZT. WEIGHT 1 PCS [kg] | ILOŚĆ [szt.] QUANTITY [pcs] | CENA / PRICE 1 szt. / pcs [PLN] |
|------------|-----------------|-----------|-----------|-----------|-----------|-------------------------------------|--------------------------------|---------------------------------------|
| ZŁKA-30001 | 40x40x2,0x25 | 40 | 40 | 25 | 2,0 | 0,03 | 200 | 2,31 |
| ZŁKA-30444 | 40x40x2,0x40 | 40 | 40 | 40 | 2,0 | 0,05 | 200 | 2,66 |
| ZŁKA-30446 | 40x40x2,0x60 | 40 | 40 | 60 | 2,0 | 0,07 | 200 | 3,70 |
| ZŁKA-30003 | 40x60x2,0x25 | 40 | 60 | 25 | 2,0 | 0,04 | 200 | 3,35 |
| ZŁKA-30005 | 60x60x2,0x25 | 60 | 60 | 25 | 2,0 | 0,05 | 200 | 3,47 |
| ZŁKA-30664 | 60x60x2,0x40 | 60 | 60 | 40 | 2,0 | 0,07 | 150 | 3,00 |
| ZŁKA-30666 | 60x60x2,0x60 | 60 | 60 | 60 | 2,0 | 0,11 | 100 | 3,70 |
| ZŁKA-30668 | 60x60x2,0x80 | 60 | 60 | 80 | 2,0 | 0,14 | 100 | 5,08 |
| ZŁKA-30886 | 80x80x2,0x60 | 80 | 80 | 60 | 2,0 | 0,14 | 100 | 5,31 |
| ZŁKA-30888 | 80x80x2,0x80 | 80 | 80 | 80 | 2,0 | 0,19 | 50 | 5,66 |
| ZŁKA-8116 | 100x100x2,5x60 | 100 | 100 | 60 | 2,5 | 0,22 | 50 | 8,43 |
| ZŁKA-8118 | 100x100x2,5x80 | 100 | 100 | 80 | 2,5 | 0,30 | 50 | 10,74 |
| ZŁKA-8111 | 100x100x2,5x100 | 100 | 100 | 100 | 2,5 | 0,37 | 50 | 11,32 |

Płytki perforowana Perforated plate

DOP H10-0005

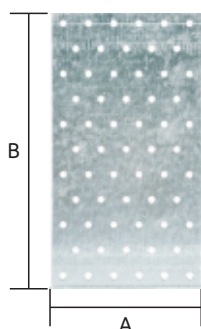

| INDEX | A [mm] | B [mm] | ≠ [mm] | WAGA 1 SZT. WEIGHT 1 PCS [kg] | ILOŚĆ [szt.] QUANTITY [pcs] | CENA / PRICE 1 szt. / pcs [PLN] |
|----------|-----------|-----------|-----------|-------------------------------------|--------------------------------|---------------------------------------|
| PP-20525 | 40 | 120 | 2 | 0,07 | 50 | 2,19 |
| PP-20530 | 40 | 160 | 2 | 0,09 | 50 | 3,23 |
| PP-20535 | 50 | 200 | 2 | 0,15 | 50 | 4,85 |
| PP-20540 | 60 | 140 | 2 | 0,12 | 50 | 3,58 |
| PP-20545 | 60 | 200 | 2 | 0,18 | 50 | 5,08 |
| PP-20550 | 60 | 240 | 2 | 0,22 | 50 | 6,58 |
| PP-20555 | 80 | 200 | 2 | 0,23 | 50 | 5,66 |
| PP-20560 | 80 | 240 | 2 | 0,29 | 50 | 7,74 |
| PP-20565 | 80 | 300 | 2 | 0,35 | 50 | 10,51 |
| PP-20575 | 100 | 200 | 2 | 0,30 | 50 | 7,05 |
| PP-20580 | 100 | 240 | 2 | 0,35 | 50 | 8,09 |
| PP-20590 | 100 | 300 | 2 | 0,45 | 25 | 13,40 |
| PP-20595 | 120 | 200 | 2 | 0,35 | 50 | 9,36 |
| PP-20600 | 120 | 240 | 2 | 0,41 | 50 | 11,43 |
| PP-20610 | 120 | 300 | 2 | 0,53 | 25 | 13,86 |

Złącze krokwiowo - płatwiowe

Rafter bracket

ETA-21-0482

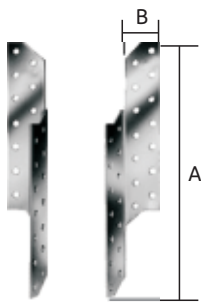

| INDEX | RODZAJ TYPE | A [mm] | B [mm] | ≠ [mm] | WAGA 1 SZT. WEIGHT 1 PCS [kg] | ILOŚĆ [szt.] QUANTITY [pcs] | CENA / PRICE 1 szt. / pcs [PLN] |
|----------|-------------|--------|--------|--------|-------------------------------|-----------------------------|---------------------------------|
| KOK-2170 | 170L | 170 | 34,5 | 2,0 | 0,10 | 100 | 4,16 |
| KOK-2171 | 170P | 170 | 34,5 | 2,0 | 0,10 | 100 | 4,16 |
| KOK-2210 | 210L | 210 | 34,5 | 2,0 | 0,13 | 100 | 5,08 |
| KOK-2211 | 210P | 210 | 34,5 | 2,0 | 0,13 | 100 | 5,08 |
| KOK-2250 | 250L | 250 | 34,5 | 2,0 | 0,17 | 100 | 6,81 |
| KOK-2251 | 250P | 250 | 34,5 | 2,0 | 0,17 | 100 | 6,81 |
| KOK-2290 | 290L | 290 | 34,5 | 2,0 | 0,21 | 100 | 9,12 |
| KOK-2291 | 290P | 290 | 34,5 | 2,0 | 0,21 | 100 | 9,12 |

Wspornik belki

Beam hanger

ETA-06-0270

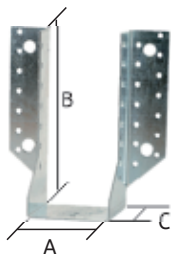

| INDEX | A [mm] | B [mm] | C [mm] | ≠ [mm] | WAGA 1 SZT. WEIGHT 1 PCS [kg] | ILOŚĆ [szt.] QUANTITY [pcs] | CENA / PRICE 1 szt. / pcs [PLN] |
|----------|--------|--------|--------|--------|-------------------------------|-----------------------------|---------------------------------|
| WSB-3103 | 40 | 110 | 60 | 2,0 | 0,27 | 50 | 12,59 |
| WSB-3109 | 51 | 104 | 60 | 2,0 | 0,27 | 50 | 10,86 |
| WSB-3209 | 60 | 130 | 60 | 2,0 | 0,38 | 50 | 13,40 |
| WSB-3215 | 70 | 125 | 60 | 2,0 | 0,38 | 50 | 14,90 |
| WSB-3221 | 80 | 120 | 60 | 2,0 | 0,38 | 50 | 11,78 |
| WSB-3318 | 100 | 140 | 60 | 2,0 | 0,43 | 40 | 15,02 |
| WSB-3421 | 120 | 160 | 60 | 2,0 | 0,58 | 25 | 18,25 |

Wspornik belki dzielony

Beam hanger

ETA-06-0270

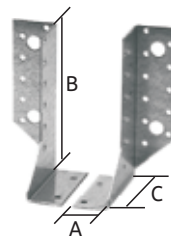

| INDEX | A [mm] | B [mm] | C [mm] | ≠ [mm] | WAGA OPAKOWANIA PACKAGING WEIGHT [kg] | ILOŚĆ [szt.] QUANTITY [pcs] | CENA / PRICE 1 szt. / pcs [PLN] |
|------------|--------|--------|--------|--------|---------------------------------------|-----------------------------|---------------------------------|
| WSBD-30030 | 30 | 118 | 84 | 2,0 | 9 | 50 | 12,01 |
| WSBD-34030 | 30 | 138 | 84 | 2,0 | 11 | 50 | 12,36 |
| WSBD-38030 | 30 | 158 | 84 | 2,0 | 13 | 50 | 12,82 |
| WSBD-44030 | 30 | 188 | 84 | 2,0 | 14,5 | 50 | 13,28 |

Pasek perforowany

Perforated belt

DOP H10-0005

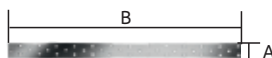

| INDEX | RODZAJ TYPE | A [mm] | B [mm] | ≠ [mm] | WAGA 1 SZT. WEIGHT 1 PCS [kg] | ILOŚĆ [szt.] QUANTITY [pcs] | CENA / PRICE 1 szt. / pcs [PLN] |
|-----------|--------------|--------|--------|--------|-------------------------------|-----------------------------|---------------------------------|
| PAP-20040 | 40x1200x2,0 | 40 | 1200 | 2,0 | 0,70 | 30 | 25,29 |
| PAP-20060 | 60x1200x2,0 | 60 | 1200 | 2,0 | 1,05 | 20 | 35,69 |
| PAP-20080 | 80x1200x2,0 | 80 | 1200 | 2,0 | 1,39 | 15 | 53,48 |
| PAP-20100 | 100x1200x2,0 | 100 | 1200 | 2,0 | 1,71 | 10 | 63,87 |
| PAP-20120 | 120x1200x2,0 | 120 | 1200 | 2,0 | 2,07 | 10 | 76,46 |

Taśma perforowana

Perforated banding

DOP H10-0001

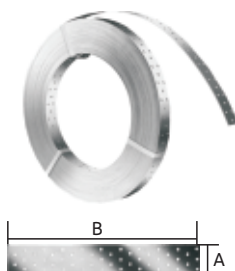

| INDEX | RODZAJ TYPE | A [mm] | B [mm] | ≠ [mm] | WAGA 1 SZT. WEIGHT 1 PCS [kg] | ILOŚĆ [szt.] QUANTITY [pcs] | CENA / PRICE 1 szt. / pcs [PLN] |
|----------|-------------|--------|--------|--------|-------------------------------|-----------------------------|---------------------------------|
| TP-27210 | 20x1,0x25 | 20 | 25 | 1,0 | 3,80 | 1 | 157,54 |
| TP-27115 | 20x1,5x10 | 20 | 10 | 1,5 | 2,29 | 1 | 92,17 |
| TP-27120 | 25x2,0x10 | 25 | 10 | 2,0 | 3,98 | 1 | 157,54 |
| TP-27252 | 25x2,0x25 | 25 | 25 | 2,0 | 9,50 | 1 | 267,61 |
| TP-27419 | 40x2,0x25 | 40 | 25 | 2,0 | 15,00 | 1 | 431,05 |
| TP-27420 | 40x2,0x50 | 40 | 50 | 2,0 | 30,00 | 1 | 787,83 |
| TP-27620 | 60x2,0x50 | 60 | 50 | 2,0 | 46,20 | 1 | 1480,59 |
| TP-27820 | 80x2,0x25 | 80 | 25 | 2,0 | 29,70 | 1 | 1144,61 |

Dwustronny łącznik do drewna

Double sided timber connector

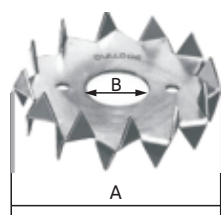

| INDEX | A [mm] | B [mm] | WAGA 1 SZT. WEIGHT 1 PCS [kg] | ILOŚĆ [szt.] QUANTITY [pcs] | CENA / PRICE 1 szt. / pcs [PLN] |
|-----------|--------|--------|-------------------------------|-----------------------------|---------------------------------|
| BUL-80210 | D 48 | 17 | 0,02 | 200 | 4,39 |
| BUL-80220 | D 62 | 21 | 0,04 | 100 | 7,39 |
| BUL-80230 | D 75 | 26 | 0,05 | 100 | 9,12 |
| BUL-80240 | D 95 | 33 | 0,09 | 40 | 17,09 |
| BUL-80250 | D 117 | 48 | 0,16 | 25 | 34,30 |

Wkręt

Screw



| INDEX | ROZMIAR SIZE [mm] | WAGA OPAKOWANIA PACKAGING WEIGHT [kg] | ILOŚĆ [szt.] QUANTITY [pcs] | CENA / PRICE 250 szt. / pcs [PLN] |
|---------|-------------------|---------------------------------------|-----------------------------|-----------------------------------|
| GWW-525 | 5,0 x 25 | 0,63 | 250 | 86,28 |
| GWW-535 | 5,0 x 35 | 0,94 | 250 | 95,17 |
| GWW-540 | 5,0 x 40 | 0,97 | 250 | 107,07 |
| GWW-550 | 5,0 x 50 | 1,15 | 250 | 118,97 |

Wspornik stupa

Pole base

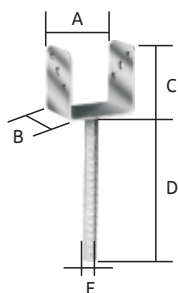

| INDEX | A [mm] | B [mm] | C [mm] | D [mm] | E [mm] | ∅ [mm] | WAGA 1 SZT. WEIGHT 1 PCS [kg] | ILOŚĆ [szt.] QUANTITY [pcs] | CENA / PRICE 1 szt. / pcs [PLN] |
|---------|--------|--------|--------|--------|--------|--------|-------------------------------|-----------------------------|---------------------------------|
| WSP-070 | 75 | 60 | 100 | 200 | 16 | 4,3 | 0,81 | 20 | 35,70 |
| WSP-080 | 83 | 60 | 100 | 200 | 16 | 4,3 | 0,84 | 20 | 36,18 |
| WSP-090 | 92 | 60 | 100 | 200 | 16 | 4,3 | 0,85 | 20 | 36,66 |
| WSP-100 | 102 | 60 | 100 | 200 | 16 | 4,3 | 0,87 | 20 | 37,15 |
| WSP-120 | 122 | 60 | 100 | 200 | 16 | 4,3 | 0,92 | 20 | 37,63 |
| WSP-140 | 142 | 60 | 100 | 200 | 16 | 4,3 | 0,94 | 20 | 38,12 |

Wspornik stupa regulowany bez podstawy

Pole base with regulation U type

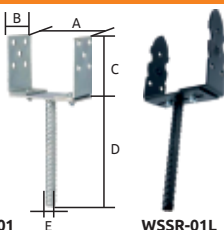

| INDEX | A [mm] | B [mm] | C [mm] | D [mm] | E [mm] | ∅ [mm] | KOLOR COLOR | ILOŚĆ [szt.] QUANTITY [pcs] | CENA / PRICE 1 szt. / pcs [PLN] |
|------------|---------|--------|--------|--------|--------|--------|----------------|-----------------------------|---------------------------------|
| WSSR-01 | 0-150 | 60 | 110 | 200 | 18 | 3,0 | ocynk / zinc | 10 | 31,60 |
| WSSR-0140 | 0-150 | 60 | 110 | 400 | 18 | 3,0 | ocynk / zinc | 10 | 41,12 |
| WSSR-01L * | 120-210 | 60 | 180 | 190 | 20 | 3,6 | czarny / black | 1 | 45,12 |

* lakierowany proszkowo na czarno / black powder coated

WSSR-01

WSSR-01L

Wspornik stupa regulowany z podstawą

Pole base with regulation T type

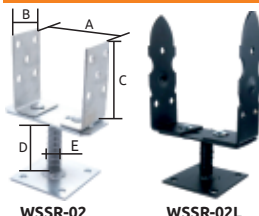

| INDEX | A [mm] | B [mm] | C [mm] | D [mm] | E [mm] | ∅ [mm] | KOLOR COLOR | ILOŚĆ [szt.] QUANTITY [pcs] | CENA / PRICE 1 szt. / pcs [PLN] |
|------------|---------|--------|--------|--------|--------|--------|----------------|-----------------------------|---------------------------------|
| WSSR-02 | 0-150 | 57 | 110 | 60 | 18 | 3,0 | ocynk / zinc | 10 | 37,12 |
| WSSR-02L * | 120-210 | 60 | 180 | 65 | 20 | 3,6 | czarny / black | 1 | 46,71 |

* lakierowany proszkowo na czarno / black powder coated

Rozmiar podstawy (the size of the base): 100 x 100 mm

WSSR-02

WSSR-02L

Wspornik stupa wbijany

Wood post anchor



| INDEX | SZEROKOŚĆ WIDTH [mm] | DŁUGOŚĆ LENGTH [mm] | ILOŚĆ [szt.] QUANTITY [pcs] | CENA / PRICE 1 szt. / pcs [PLN] |
|----------|----------------------|---------------------|-----------------------------|---------------------------------|
| WSSW-051 | 51 x 51 | 600 | 1 | 27,20 |
| WSSW-061 | 61 x 61 | 750 | 1 | 31,74 |
| WSSW-070 | 71 x 71 | 750 | 1 | 42,18 |
| WSSW-080 | 81 x 81 | 750 | 1 | 53,66 |
| WSSW-090 | 91 x 91 | 750 | 1 | 60,56 |
| WSSW-100 | 101 x 101 | 750 | 1 | 67,46 |
| WSSW-120 | 121 x 121 | 750 | 1 | 80,00 |

Podkładka ciesielska kwadratowa prosta

Square carpenter washer

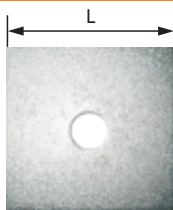

| INDEX | ŚREDNICA OTWORU HOLE DIAMETER [mm] | L [mm] | ILOŚĆ [szt.] QUANTITY [pcs] | CENA / PRICE 1 szt. / pcs [PLN] |
|--------|--|-----------|--------------------------------|---------------------------------------|
| PCP-10 | 10 | 80 | 50 | 6,00 |
| PCP-12 | 12 | 80 | 50 | 6,00 |
| PCP-14 | 14 | 80 | 50 | 6,00 |
| PCP-16 | 16 | 80 | 50 | 6,00 |
| PCP-20 | 20 | 80 | 50 | 6,00 |

Podkładka ciesielska kwadratowa przetłaczana

Square carpenter washer

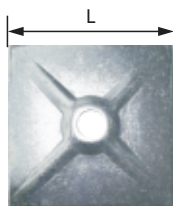

| INDEX | ŚREDNICA OTWORU HOLE DIAMETER [mm] | L [mm] | ILOŚĆ [szt.] QUANTITY [pcs] | CENA / PRICE 1 szt. / pcs [PLN] |
|----------|--|-----------|--------------------------------|---------------------------------------|
| PCPRZ-08 | 8 | 80 | 50 | 6,50 |
| PCPRZ-10 | 10 | 80 | 50 | 6,50 |
| PCPRZ-12 | 12 | 80 | 50 | 6,50 |
| PCPRZ-14 | 14 | 80 | 50 | 6,50 |
| PCPRZ-16 | 16 | 80 | 50 | 6,50 |

Ceownik wzmocniony (2mb)

Support Channel

PN-EN 61537:2007



| INDEX | Ø [mm] | SZEROKOŚĆ WIDTH [mm] | DŁUGOŚĆ LENGTH [mm] | WYSOKOŚĆ HEIGHT [mm] | WAGA 1 SZT. WEIGHT 1 PCS [kg] | CENA / PRICE 1 szt. / pcs [PLN] |
|--------------|--------|----------------------|---------------------|----------------------|-------------------------------|---------------------------------|
| BAKS-CWZ1220 | 1,2 | 40 | 2000 | 22 | 1,60 | 25,47 |
| BAKS-CWZ1520 | 1,5 | 40 | 2000 | 22 | 2,03 | 29,57 |
| BAKS-CWZ-020 | 2,0 | 40 | 2000 | 22 | 2,68 | 36,39 |
| BAKS-CWZ1235 | 1,2 | 40 | 2000 | 35 | 2,02 | 33,40 |
| BAKS-CWZ1535 | 1,5 | 40 | 2000 | 35 | 2,32 | 41,13 |
| BAKS-CWZ2035 | 2,0 | 40 | 2000 | 35 | 3,02 | 51,54 |
| BAKS-CWZ1240 | 1,2 | 40 | 2000 | 40 | 2,20 | 35,62 |
| BAKS-CWZ1540 | 1,5 | 40 | 2000 | 40 | 2,60 | 42,94 |
| BAKS-CWZ2040 | 2,0 | 40 | 2000 | 40 | 3,50 | 56,14 |

Ceownik (2mb)

Channel

PN-EN 61537:2007



| INDEX | Ø [mm] | SZEROKOŚĆ WIDTH [mm] | DŁUGOŚĆ LENGTH [mm] | WYSOKOŚĆ HEIGHT [mm] | WAGA 1 SZT. WEIGHT 1 PCS [kg] | CENA / PRICE 1 szt. / pcs [PLN] |
|------------|--------|----------------------|---------------------|----------------------|-------------------------------|---------------------------------|
| BAKS-C1228 | 1,2 | 28 | 2000 | 12 | 0,84 | 15,15 |
| BAKS-C1528 | 1,5 | 28 | 2000 | 12 | 0,92 | 16,90 |
| BAKS-C2028 | 2,0 | 28 | 2000 | 12 | 1,16 | 22,50 |
| BAKS-C1240 | 1,2 | 40 | 2000 | 20 | 1,46 | 22,49 |
| BAKS-C1540 | 1,5 | 40 | 2000 | 20 | 1,56 | 25,26 |
| BAKS-C2040 | 2,0 | 40 | 2000 | 20 | 2,10 | 32,85 |
| BAKS-C3050 | 3,0 | 50 | 2000 | 30 | 4,48 | 71,54 |

Pokrywa korytka kablowego (2mb)

Cover

PN-EN 61537:2007



| INDEX | SZEROKOŚĆ WIDTH [mm] | PKR ≠ 0,5mm | | PKL ≠ 0,7mm | | PKJ ≠ 1,0mm | |
|-------------|----------------------|----------------------|-------------------------|----------------------|-------------------------|----------------------|-------------------------|
| | | WAGA WEIGHT [1mb/kg] | CENA / PRICE 1 mb [PLN] | WAGA WEIGHT [1mb/kg] | CENA / PRICE 1 mb [PLN] | WAGA WEIGHT [1mb/kg] | CENA / PRICE 1 mb [PLN] |
| BAKS-PKR035 | 35 | 0,18 | 4,24 | - | - | - | - |
| BAKS-PKR050 | 50 | 0,28 | 5,12 | 0,42 | 5,50 | 0,64 | 6,86 |
| BAKS-PKR100 | 100 | 0,45 | 7,76 | 0,72 | 9,90 | 1,04 | 12,21 |
| BAKS-PKR150 | 150 | 0,67 | 9,53 | 1,02 | 13,40 | 1,44 | 16,25 |
| BAKS-PKR200 | 200 | 0,86 | 12,01 | 1,32 | 18,32 | 1,84 | 22,13 |
| BAKS-PKR300 | 300 | 1,25 | 18,08 | 1,92 | 25,24 | 2,64 | 32,01 |

Podstawa wspornika

Fixing Channel

PN-EN 61537:2007

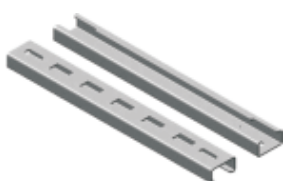

| INDEX | DŁUGOŚĆ LENGTH [mm] | WAGA 1 SZT. WEIGHT 1 PCS [kg] | IŁOŚĆ [szt.] QUANTITY [pcs] | CENA / PRICE 1 szt. / pcs [PLN] |
|------------|---------------------|-------------------------------|-----------------------------|---------------------------------|
| BAKS-PWŚ01 | 110 | 0,09 | 100 | 2,87 |
| BAKS-PWŚ02 | 200 | 0,23 | 30 | 5,99 |
| BAKS-PWŚ03 | 300 | 0,33 | 30 | 8,96 |
| BAKS-PWŚ04 | 400 | 0,43 | 30 | 11,57 |
| BAKS-PWŚ05 | 500 | 0,53 | 30 | 13,60 |
| BAKS-PWŚ1 | 1000 | 1,06 | 10 | 23,00 |
| BAKS-PWŚ2 | 2000 | 2,01 | 8 | 45,96 |
| BAKS-PWŚ3 | 3000 | 3,10 | 8 | 68,96 |

Szyna perforowana "EURO" (1m)

Perforated rail

PN-EN 61537:2007



| INDEX | Ø [mm] | SZEROKOŚĆ WIDTH [mm] | WYSOKOŚĆ HEIGHT [mm] | WAGA 1 SZT. WEIGHT 1 PCS [kg] | IŁOŚĆ [szt.] QUANTITY [pcs] | CENA / PRICE 1 szt. / pcs [PLN] |
|-------------|--------|----------------------|----------------------|-------------------------------|-----------------------------|---------------------------------|
| BAKS-SZPE07 | 1,0 | 35 | 7 | 0,29 | 50 | 5,92 |
| BAKS-SZPE15 | 1,0 | 35 | 15 | 0,40 | 50 | 7,92 |

Ceownik montażowy (2mb)
Support Channel

PN-EN 61537:2007



| INDEX | ≠ [mm] | SZEROKOŚĆ WIDTH [mm] | DŁUGOŚĆ LENGTH [mm] | WYSOKOŚĆ HEIGHT [mm] | WAGA 1 SZT. WEIGHT 1 PCS [kg] | ILOŚĆ [szt.] QUANTITY [pcs] | CENA / PRICE 1 szt. / pcs [PLN] |
|---------------|-----------|----------------------------|---------------------------|----------------------------|-------------------------------------|--------------------------------|---------------------------------------|
| BAKS-CM154121 | 1,5 | 41 | 2000 | 21 | 2,34 | 12 | 31,61 |
| BAKS-CM204121 | 2,0 | 41 | 2000 | 21 | 3,12 | 12 | 39,37 |
| BAKS-CM154141 | 1,5 | 41 | 2000 | 41 | 2,64 | 12 | 42,94 |
| BAKS-CM204141 | 2,0 | 41 | 2000 | 41 | 3,56 | 12 | 56,74 |
| BAKS-CM155050 | 1,5 | 50 | 2000 | 50 | 3,80 | 12 | 51,81 |
| BAKS-CM205050 | 2,0 | 50 | 2000 | 50 | 5,36 | 12 | 66,41 |

Wysięgnik wzmocniony
Bracket

PN-EN 61537:2007



| INDEX | SZEROKOŚĆ WIDTH [mm] | WYSOKOŚĆ HEIGHT [mm] | WAGA 1 SZT. WEIGHT 1 PCS [kg] | ILOŚĆ [szt.] QUANTITY [pcs] | CENA / PRICE 1 szt. / pcs [PLN] |
|------------|----------------------------|----------------------------|-------------------------------------|--------------------------------|---------------------------------------|
| BAKS-WW050 | 60 | 48 | 0,05 | 100 | 2,48 |
| BAKS-WW100 | 110 | 70 | 0,09 | 100 | 3,26 |
| BAKS-WW150 | 160 | 70 | 0,12 | 100 | 4,44 |
| BAKS-WW200 | 210 | 75 | 0,22 | 100 | 5,58 |
| BAKS-WW300 | 315 | 95 | 0,40 | 50 | 9,17 |
| BAKS-WW400 | 415 | 95 | 0,57 | 50 | 12,52 |
| BAKS-WW500 | 515 | 95 | 0,80 | 50 | 14,87 |
| BAKS-WW600 | 615 | 95 | 0,91 | 50 | 17,70 |

Kątownik (2mb)
Angle profile

PN-EN 61537:2007

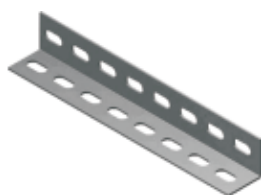

| INDEX | ≠ [mm] | SZEROKOŚĆ WIDTH [mm] | WYSOKOŚĆ HEIGHT [mm] | WAGA 1 SZT. WEIGHT 1 PCS [kg] | ILOŚĆ [szt.] QUANTITY [pcs] | CENA / PRICE 1mb [PLN] |
|-------------|-----------|----------------------------|----------------------------|-------------------------------------|--------------------------------|------------------------------|
| BAKS-KA1225 | 1,2 | 25 | 25 | 0,80 | 10 | 7,51 |
| BAKS-KA1235 | 1,2 | 35 | 35 | 1,08 | 10 | 10,26 |
| BAKS-KA1525 | 1,5 | 25 | 25 | 0,82 | 10 | 9,14 |
| BAKS-KA1535 | 1,5 | 35 | 35 | 1,30 | 10 | 11,70 |
| BAKS-KA2025 | 2,0 | 25 | 25 | 1,08 | 10 | 10,36 |
| BAKS-KA2035 | 2,0 | 35 | 35 | 1,58 | 10 | 14,37 |
| BAKS-KA3050 | 3,0 | 50 | 50 | 4,00 | 10 | 31,61 |

Płaskownik (2mb)
Punch flat bar

PN-EN 61537:2007



| INDEX | ≠ [mm] | SZEROKOŚĆ WIDTH [mm] | WAGA 1 SZT. WEIGHT 1 PCS [kg] | ILOŚĆ [szt.] QUANTITY [pcs] | CENA / PRICE 1mb [PLN] |
|-------------|-----------|----------------------------|-------------------------------------|--------------------------------|------------------------------|
| BAKS-PŁ1212 | 1,2 | 12 | 0,10 | 50 | 3,54 |
| BAKS-PŁ1516 | 1,5 | 16 | 0,17 | 50 | 5,09 |
| BAKS-PŁ1525 | 1,5 | 25 | 0,25 | 50 | 5,60 |
| BAKS-PŁ2025 | 2,0 | 25 | 0,30 | 50 | 6,87 |
| BAKS-PŁ2525 | 2,5 | 25 | 0,37 | 50 | 8,03 |
| BAKS-PŁ3030 | 3,0 | 30 | 0,45 | 50 | 10,57 |

Drabinka kablowa H45 (3mb)
Cable Ladder

PN-EN 61537:2007



| INDEX | WYSOKOŚĆ HEIGHT [mm] | ILOŚĆ [szt.] QUANTITY [pcs] | DKP ≠ 1,5mm | | DKC ≠ 2,0mm | |
|------------|----------------------------|--------------------------------|----------------------------|-------------------------------|----------------------------|-------------------------------|
| | | | WAGA WEIGHT [1mb/kg] | CENA / PRICE 1 mb [PLN] | WAGA WEIGHT [1mb/kg] | CENA / PRICE 1 mb [PLN] |
| BAKS-DK100 | 45 | 1 | 2,06 | 35,69 | 2,74 | 46,02 |
| BAKS-DK200 | 45 | 1 | 2,33 | 37,74 | 3,10 | 48,88 |
| BAKS-DK300 | 45 | 1 | 2,61 | 40,82 | 3,48 | 53,03 |
| BAKS-DK400 | 45 | 1 | 3,02 | 43,89 | 4,02 | 57,15 |
| BAKS-DK500 | 45 | 1 | 3,15 | 46,99 | 4,20 | 61,29 |
| BAKS-DK600 | 45 | 1 | 3,43 | 50,05 | 4,57 | 65,43 |

Korytko kablowe metalowe (2mb)
Cable Tray

PN-EN 61537:2007



| INDEX | WYSOKOŚĆ HEIGHT [mm] | SZEROKOŚĆ WIDTH [mm] | KGR ≠ 0,5mm | | KGL ≠ 0,7mm | | KGJ ≠ 1,0mm | |
|-------------|----------------------------|----------------------------|----------------------------|-------------------------------|----------------------------|-------------------------------|----------------------------|-------------------------------|
| | | | WAGA WEIGHT [1mb/kg] | CENA / PRICE 1 mb [PLN] | WAGA WEIGHT [1mb/kg] | CENA / PRICE 1 mb [PLN] | WAGA WEIGHT [1mb/kg] | CENA / PRICE 1 mb [PLN] |
| BAKS-KGR035 | 30 | 35 | 0,42 | 8,20 | 0,57 | 14,84 | 0,76 | 17,62 |
| BAKS-KGR050 | 42 | 50 | 0,55 | 9,72 | 0,76 | 15,98 | 1,08 | 20,51 |
| BAKS-KGR100 | 42 | 100 | 0,73 | 12,76 | 1,00 | 17,00 | 1,41 | 24,91 |
| BAKS-KGR150 | 42 | 150 | 0,92 | 15,20 | 1,26 | 21,50 | 1,75 | 30,43 |
| BAKS-KGR200 | 42 | 200 | 1,10 | 17,99 | 1,51 | 25,30 | 2,08 | 37,76 |
| BAKS-KGR300 | 42 | 300 | 1,45 | 25,13 | 1,99 | 34,55 | 2,74 | 48,49 |

Śruba z łbem sześciokątnym z gwintem na całej długości
Hexagonal head bolt fully threaded

PN-82105 / DIN 933

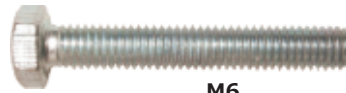

| DŁUGOŚĆ LENGTH [mm] | M5 | | | | M6 | | | | M8 | | | |
|---------------------------|---------|---|--|--------------------------------|---------|---|--|--------------------------------|---------|---|--|--------------------------------|
| | INDEX | WAGA 1000 szt. WEIGHT 1000 pcs [kg] | ILOŚĆ [szt./kg] QUANTITY [pcs/kg] | CENA PRICE 1 kg [PLN] | INDEX | WAGA 1000 szt. WEIGHT 1000 pcs [kg] | ILOŚĆ [szt./kg] QUANTITY [pcs/kg] | CENA PRICE 1 kg [PLN] | INDEX | WAGA 1000 szt. WEIGHT 1000 pcs [kg] | ILOŚĆ [szt./kg] QUANTITY [pcs/kg] | CENA PRICE 1 kg [PLN] |
| 10 | Ś505010 | 2,40 | 417 | 23,38 | Ś506010 | 4,16 | 240 | 21,00 | | | | |
| 12 | Ś505012 | 2,50 | 400 | 23,38 | Ś506012 | 4,32 | 231 | 21,00 | | | | |
| 14 | Ś505014 | 2,60 | 385 | 23,38 | Ś506014 | 4,80 | 208 | 21,00 | Ś508014 | 9,80 | 102 | 20,31 |
| 16 | Ś505016 | 3,20 | 313 | 23,38 | Ś506016 | 5,40 | 185 | 21,00 | Ś508016 | 10,60 | 94 | 20,31 |
| 20 | Ś505020 | 3,66 | 273 | 23,38 | Ś506020 | 6,00 | 167 | 21,00 | Ś508020 | 11,80 | 85 | 20,31 |
| 25 | Ś505025 | 4,36 | 229 | 23,38 | Ś506025 | 6,80 | 147 | 21,00 | Ś508025 | 13,30 | 75 | 20,31 |
| 30 | Ś505030 | 4,90 | 204 | 23,38 | Ś506030 | 7,56 | 132 | 21,00 | Ś508030 | 15,00 | 67 | 20,31 |
| 35 | Ś505035 | 5,58 | 179 | 23,38 | Ś506035 | 8,52 | 117 | 21,00 | Ś508035 | 16,60 | 60 | 20,31 |
| 40 | Ś505040 | 6,14 | 163 | 23,38 | Ś506040 | 9,42 | 106 | 21,00 | Ś508040 | 18,10 | 55 | 20,31 |
| 45 | Ś505045 | 6,84 | 146 | 23,38 | Ś506045 | 10,40 | 96 | 21,00 | Ś508045 | 19,40 | 52 | 20,31 |
| 50 | Ś505050 | 7,30 | 137 | 23,38 | Ś506050 | 11,10 | 90 | 21,00 | Ś508050 | 21,40 | 47 | 20,31 |
| 55 | Ś505055 | 8,10 | 123 | 23,38 | Ś506055 | 11,90 | 84 | 21,00 | Ś508055 | 22,60 | 44 | 20,31 |
| 60 | Ś505060 | 8,54 | 117 | 23,38 | Ś506060 | 12,90 | 78 | 21,00 | Ś508060 | 24,20 | 41 | 20,31 |
| 65 | | | | | Ś506065 | 13,50 | 74 | 21,00 | Ś508065 | 25,30 | 40 | 20,31 |
| 70 | | | | | Ś506070 | 14,30 | 70 | 21,00 | Ś508070 | 27,50 | 36 | 20,31 |
| 75 | | | | | | | | | Ś508075 | 29,10 | 34 | 20,31 |
| 80 | | | | | Ś506080 | 15,10 | 66 | 21,00 | Ś508080 | 30,70 | 33 | 20,31 |
| 90 | | | | | | | | | Ś508090 | 33,40 | 30 | 20,31 |
| 100 | | | | | | | | | Ś508100 | 36,50 | 27 | 20,31 |
| 120 | | | | | | | | | Ś508120 | 44,00 | 23 | 20,31 |

| DŁUGOŚĆ LENGTH [mm] | M10 | | | | M12 | | | | M14 | | | |
|---------------------------|---------|---|--|--------------------------------|---------|---|--|--------------------------------|---------|---|--|--------------------------------|
| | INDEX | WAGA 1000 szt. WEIGHT 1000 pcs [kg] | ILOŚĆ [szt./kg] QUANTITY [pcs/kg] | CENA PRICE 1 kg [PLN] | INDEX | WAGA 1000 szt. WEIGHT 1000 pcs [kg] | ILOŚĆ [szt./kg] QUANTITY [pcs/kg] | CENA PRICE 1 kg [PLN] | INDEX | WAGA 1000 szt. WEIGHT 1000 pcs [kg] | ILOŚĆ [szt./kg] QUANTITY [pcs/kg] | CENA PRICE 1 kg [PLN] |
| 16 | Ś510016 | 19,23 | 52 | 20,10 | | | | | | | | |
| 20 | Ś510020 | 21,60 | 46 | 20,10 | Ś512020 | 31,10 | 32 | 20,10 | | | | |
| 25 | Ś510025 | 23,80 | 42 | 20,10 | Ś512025 | 35,00 | 29 | 20,10 | | | | |
| 30 | Ś510030 | 26,60 | 38 | 20,10 | Ś512030 | 39,10 | 26 | 20,10 | | | | |
| 35 | Ś510035 | 29,10 | 34 | 20,10 | Ś512035 | 42,60 | 23 | 20,10 | Ś514035 | 63,00 | 16 | 20,10 |
| 40 | Ś510040 | 31,60 | 32 | 20,10 | Ś512040 | 45,80 | 22 | 20,10 | Ś514040 | 67,70 | 15 | 20,10 |
| 45 | Ś510045 | 33,90 | 29 | 20,10 | Ś512045 | 49,60 | 20 | 20,10 | Ś514045 | 72,20 | 14 | 20,10 |
| 50 | Ś510050 | 36,40 | 27 | 20,10 | Ś512050 | 53,40 | 19 | 20,10 | Ś514050 | 77,60 | 13 | 20,10 |
| 55 | Ś510055 | 38,60 | 26 | 20,10 | Ś512055 | 58,20 | 17 | 20,10 | Ś514055 | 82,30 | 12 | 20,10 |
| 60 | Ś510060 | 41,20 | 24 | 20,10 | Ś512060 | 60,60 | 17 | 20,10 | Ś514060 | 87,80 | 11 | 20,10 |
| 65 | Ś510065 | 44,70 | 20 | 20,10 | Ś512065 | 64,50 | 16 | 20,10 | Ś514065 | 92,10 | 11 | 20,10 |
| 70 | Ś510070 | 46,20 | 22 | 20,10 | Ś512070 | 67,30 | 15 | 20,10 | Ś514070 | 97,50 | 10 | 20,10 |
| 75 | Ś510075 | 48,80 | 20 | 20,10 | Ś512075 | 70,10 | 14 | 20,10 | Ś514075 | 102,20 | 10 | 20,10 |
| 80 | Ś510080 | 51,60 | 19 | 20,10 | Ś512080 | 74,30 | 13 | 20,10 | Ś514080 | 107,40 | 9 | 20,10 |
| 90 | Ś510090 | 56,00 | 18 | 20,10 | Ś512090 | 81,80 | 12 | 20,10 | Ś514090 | 115,50 | 9 | 20,10 |
| 100 | Ś510100 | 60,80 | 16 | 20,10 | Ś512100 | 88,60 | 11 | 20,10 | Ś514100 | 142,85 | 7 | 20,10 |
| 120 | Ś510120 | 71,00 | 14 | 20,10 | Ś512120 | 102,00 | 10 | 20,10 | | | | |

| DŁUGOŚĆ LENGTH [mm] | M16 | | | | M20 | | | |
|---------------------------|---------|---|--|--------------------------------|---------|---|--|--------------------------------|
| | INDEX | WAGA 1000 szt. WEIGHT 1000 pcs [kg] | ILOŚĆ [szt./kg] QUANTITY [pcs/kg] | CENA PRICE 1 kg [PLN] | INDEX | WAGA 1000 szt. WEIGHT 1000 pcs [kg] | ILOŚĆ [szt./kg] QUANTITY [pcs/kg] | CENA PRICE 1 kg [PLN] |
| 30 | Ś516030 | 76,00 | 13,2 | 18,77 | | | | |
| 35 | Ś516035 | 80,00 | 12,5 | 18,77 | | | | |
| 40 | Ś516040 | 89,20 | 11,2 | 18,77 | Ś520040 | 155 | 6,5 | 18,77 |
| 45 | Ś516045 | 95,80 | 10,4 | 18,77 | Ś520045 | 165 | 6,1 | 18,77 |
| 50 | Ś516050 | 102,00 | 9,8 | 18,77 | Ś520050 | 175 | 5,7 | 18,77 |
| 55 | Ś516055 | 108,60 | 9,2 | 18,77 | Ś520055 | 185 | 5,4 | 18,77 |
| 60 | Ś516060 | 115,40 | 8,7 | 18,77 | Ś520060 | 195 | 5,1 | 18,77 |
| 65 | Ś516065 | 121,50 | 8,2 | 18,77 | Ś520065 | 205 | 4,9 | 18,77 |
| 70 | Ś516070 | 128,40 | 7,8 | 18,77 | Ś520070 | 215 | 4,7 | 18,77 |
| 75 | Ś516075 | 134,20 | 7,5 | 18,77 | Ś520075 | 224 | 4,5 | 18,77 |
| 80 | Ś516080 | 141,60 | 7,1 | 18,77 | Ś520080 | 234 | 4,3 | 18,77 |
| 90 | Ś516090 | 155,00 | 6,5 | 18,77 | Ś520090 | 254 | 3,9 | 18,77 |
| 100 | Ś516100 | 167,40 | 6,0 | 18,77 | Ś520100 | 274 | 3,6 | 18,77 |

Śruba z łbem grzybkowym podsadzonym
Round head square neck bolt partially threaded

PN-82406 / DIN 603

**M5****M6**

| DŁUGOŚĆ LENGTH [mm] | INDEX | WAGA 1000 szt. WEIGHT 1000 pcs [kg] | ILOŚĆ [szt./kg] QUANTITY [pcs/kg] | CENA / PRICE 1 kg [PLN] | INDEX | WAGA 1000 szt. WEIGHT 1000 pcs [kg] | ILOŚĆ [szt./kg] QUANTITY [pcs/kg] | CENA / PRICE 1 kg [PLN] |
|---------------------------|----------|---|--|---------------------------------|----------|---|--|---------------------------------|
| | | | | | | | | |
| 16 | ŚZA05016 | 4,50 | 222 | 21,38 | ŚZA06016 | 6,10 | 164 | 19,23 |
| 20 | ŚZA05020 | 4,70 | 213 | 21,38 | ŚZA06020 | 6,60 | 152 | 19,23 |
| 25 | ŚZA05025 | 4,90 | 204 | 21,38 | ŚZA06025 | 7,16 | 140 | 19,23 |
| 30 | ŚZA05030 | 5,27 | 190 | 21,38 | ŚZA06030 | 8,02 | 125 | 19,23 |
| 35 | ŚZA05035 | 5,87 | 170 | 21,38 | ŚZA06035 | 8,88 | 113 | 19,23 |
| 40 | ŚZA05040 | 6,47 | 155 | 21,38 | ŚZA06040 | 9,74 | 103 | 19,23 |
| 45 | ŚZA05045 | 7,06 | 142 | 21,38 | ŚZA06045 | 10,60 | 94 | 19,23 |
| 50 | ŚZA05050 | 7,66 | 131 | 21,38 | ŚZA06050 | 11,50 | 87 | 19,23 |
| 55 | ŚZA05055 | 8,26 | 121 | 21,38 | ŚZA06055 | 12,30 | 81 | 19,23 |
| 60 | ŚZA05060 | 8,86 | 113 | 21,38 | ŚZA06060 | 13,20 | 76 | 19,23 |
| 65 | ŚZA05065 | 9,46 | 106 | 21,38 | ŚZA06065 | 14,00 | 71 | 19,23 |
| 70 | ŚZA05070 | 10,10 | 99 | 21,38 | ŚZA06070 | 14,90 | 67 | 19,23 |
| 75 | | | | | ŚZA06075 | 15,80 | 63 | 19,23 |
| 80 | ŚZA05080 | 11,34 | 85 | 21,38 | ŚZA06080 | 16,60 | 60 | 19,23 |
| 90 | | | | | ŚZA06090 | 18,40 | 54 | 19,23 |
| 100 | | | | | ŚZA06100 | 20,50 | 49 | 19,23 |
| 110 | | | | | ŚZA06110 | 22,10 | 45 | 19,23 |
| 120 | | | | | ŚZA06120 | 23,60 | 42 | 19,23 |

M8**M10**

| DŁUGOŚĆ LENGTH [mm] | INDEX | WAGA 1000 szt. WEIGHT 1000 pcs [kg] | ILOŚĆ [szt./kg] QUANTITY [pcs/kg] | CENA / PRICE 1 kg [PLN] | INDEX | WAGA 1000 szt. WEIGHT 1000 pcs [kg] | ILOŚĆ [szt./kg] QUANTITY [pcs/kg] | CENA / PRICE 1 kg [PLN] |
|---------------------------|----------|---|--|---------------------------------|----------|---|--|---------------------------------|
| | | | | | | | | |
| 12 | ŚZA08012 | 16,67 | 60 | 19,23 | | | | |
| 16 | ŚZA08016 | 15,15 | 66 | 19,23 | | | | |
| 20 | ŚZA08020 | 12,40 | 72 | 19,23 | | | | |
| 25 | ŚZA08025 | 13,90 | 65 | 19,23 | ŚZA10025 | 25,50 | 39,2 | 19,23 |
| 30 | ŚZA08030 | 15,40 | 59 | 19,23 | ŚZA10030 | 27,00 | 37,0 | 19,23 |
| 35 | ŚZA08035 | 17,00 | 54 | 19,23 | ŚZA10035 | 29,50 | 33,9 | 19,23 |
| 40 | ŚZA08040 | 18,50 | 54 | 19,23 | ŚZA10040 | 32,00 | 31,3 | 19,23 |
| 45 | ŚZA08045 | 20,00 | 50 | 19,23 | ŚZA10045 | 34,40 | 29,1 | 19,23 |
| 50 | ŚZA08050 | 21,60 | 46 | 19,23 | ŚZA10050 | 36,90 | 27,1 | 19,23 |
| 55 | ŚZA08055 | 23,20 | 43 | 19,23 | ŚZA10055 | 39,40 | 25,4 | 19,23 |
| 60 | ŚZA08060 | 24,80 | 40 | 19,23 | ŚZA10060 | 41,80 | 23,9 | 19,23 |
| 65 | ŚZA08065 | 26,30 | 38 | 19,23 | ŚZA10065 | 44,30 | 22,6 | 19,23 |
| 70 | ŚZA08070 | 28,00 | 36 | 19,23 | ŚZA10070 | 46,70 | 21,4 | 19,23 |
| 75 | ŚZA08075 | 29,60 | 34 | 19,23 | ŚZA10075 | 49,20 | 20,3 | 19,23 |
| 80 | ŚZA08080 | 31,20 | 32 | 19,23 | ŚZA10080 | 51,70 | 19,3 | 19,23 |
| 90 | ŚZA08090 | 34,40 | 29 | 19,23 | ŚZA10090 | 56,60 | 17,7 | 19,23 |
| 100 | ŚZA08100 | 37,60 | 27 | 19,23 | ŚZA10100 | 61,50 | 16,3 | 19,23 |
| 110 | ŚZA08110 | 42,20 | 24 | 19,23 | ŚZA10110 | 66,50 | 15,0 | 19,23 |
| 120 | ŚZA08120 | 43,40 | 23 | 19,23 | ŚZA10120 | 71,40 | 14,0 | 19,23 |
| 130 | ŚZA08130 | 47,50 | 21 | 19,23 | ŚZA10130 | 76,30 | 13,1 | 19,23 |
| 140 | ŚZA08140 | 49,90 | 20 | 19,23 | ŚZA10140 | 81,20 | 12,3 | 19,23 |
| 150 | ŚZA08150 | 54,80 | 18 | 19,23 | ŚZA10150 | 86,20 | 11,7 | 19,23 |
| 160 | ŚZA08160 | 58,80 | 17 | 19,23 | ŚZA10160 | 100,00 | 10,0 | 19,23 |
| 180 | ŚZA08180 | 62,50 | 16 | 19,23 | ŚZA10180 | 111,00 | 9,0 | 19,23 |
| 200 | ŚZA08200 | 71,45 | 14 | 19,23 | ŚZA10200 | 125,00 | 8,0 | 19,23 |
| 220 | | | | | ŚZA10220 | 139,00 | 7,0 | 19,23 |

Śruba z tłem grzybkowym podszonym

Round head square neck bolt partially threaded

PN-82406 / DIN 603



| DEŁGOSĆ LENGTH [mm] | INDEX | WAGA 1000 szt. WEIGHT 1000 pcs [kg] | ILOŚĆ [szt./kg] QUANTITY [pcs/kg] | CENA / PRICE 1 kg [PLN] |
|---------------------------|----------|---|--|-------------------------------|
| 40 | ŚZA12040 | 56,10 | 17,8 | 19,23 |
| 50 | ŚZA12050 | 62,83 | 15,9 | 19,23 |
| 60 | ŚZA12060 | 69,89 | 14,3 | 19,23 |
| 70 | ŚZA12070 | 76,98 | 13,0 | 19,23 |
| 80 | ŚZA12080 | 84,02 | 11,9 | 19,23 |
| 90 | ŚZA12090 | 91,08 | 11,0 | 19,23 |
| 100 | ŚZA12100 | 98,15 | 10,2 | 19,23 |
| 110 | ŚZA12110 | 105,21 | 9,5 | 19,23 |
| 120 | ŚZA12120 | 112,28 | 8,9 | 19,23 |
| 130 | ŚZA12130 | 119,34 | 8,4 | 19,23 |
| 140 | ŚZA12140 | 126,41 | 7,9 | 19,23 |
| 150 | ŚZA12150 | 133,47 | 7,5 | 19,23 |
| 160 | ŚZA12160 | 140,53 | 7,1 | 19,23 |
| 180 | ŚZA12180 | 154,66 | 6,5 | 19,23 |
| 200 | ŚZA12200 | 168,79 | 5,9 | 19,23 |
| 220 | ŚZA12220 | 182,93 | 5,3 | 19,23 |
| 240 | ŚZA12240 | 197,07 | 4,7 | 19,23 |
| 260 | ŚZA12260 | 211,21 | 4,1 | 19,23 |

Wkręt dwugwintowy

Hanger bolt

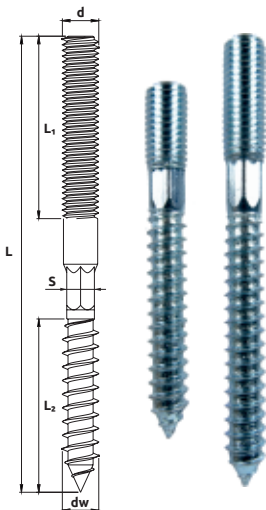

| INDEX | ROZMIAR SIZE [mm] | | | | | ILOŚĆ [szt./kg] QUANTITY [pcs/kg] | ILOŚĆ [szt.] QUANTITY [pcs] | | CENA / PRICE 1000 szt./pcs [PLN] | |
|-----------|----------------------|-----|-----|----------------|----------------|--|--------------------------------|-----|--|----------|
| | d | L | dw | L ₁ | L ₂ | | | | | |
| WDT-08050 | 8 | 50 | 7,2 | 10 | 30 | 6 | 80 | 200 | 1200 | 226,01 |
| WDT-08060 | 8 | 60 | 7,2 | 20 | 30 | 6 | 71 | 200 | 1200 | 250,98 |
| WDT-08070 | 8 | 70 | 7,2 | 25 | 30 | 6 | 60 | 200 | 1200 | 292,89 |
| WDT-08080 | 8 | 80 | 7,2 | 30 | 40 | 6 | 52 | 200 | 1200 | 334,80 |
| WDT-08100 | 8 | 100 | 7,2 | 40 | 47 | 6 | 42 | 100 | 1000 | 419,70 |
| WDT-08120 | 8 | 120 | 7,2 | 50 | 50 | 6 | 33 | 100 | 800 | 535,55 |
| WDT-08140 | 8 | 140 | 7,2 | 50 | 57 | 6 | 28 | 100 | 600 | 636,00 |
| WDT-08160 | 8 | 160 | 7,2 | 50 | 57 | 6 | 24 | 100 | 600 | 771,72 |
| WDT-08180 | 8 | 180 | 7,2 | 50 | 57 | 6 | 21 | 100 | 400 | 857,49 |
| WDT-08200 | 8 | 200 | 7,2 | 50 | 57 | 6 | 20 | 100 | 400 | 926,06 |
| WDT-08220 | 8 | 220 | 7,2 | 50 | 57 | 6 | 19 | 100 | 400 | 1 205,88 |
| WDT-08250 | 8 | 250 | 7,2 | 70 | 57 | 6 | 17 | 100 | 300 | 1 419,38 |
| WDT-08280 | 8 | 280 | 7,2 | 70 | 57 | 6 | 15 | 100 | 300 | 1 612,03 |
| WDT-08300 | 8 | 300 | 7,2 | 70 | 57 | 6 | 12 | 100 | 300 | 1 731,35 |
| WDT-08350 | 8 | 350 | 7,2 | 70 | 57 | 6 | 7 | 100 | 300 | 2 583,21 |
| WDT-10060 | 10 | 60 | 9,2 | 18 | 30 | 8 | 40 | 100 | 1000 | 392,35 |
| WDT-10080 | 10 | 80 | 9,2 | 30 | 40 | 8 | 35 | 100 | 800 | 571,52 |
| WDT-10100 | 10 | 100 | 9,2 | 30 | 57 | 8 | 28 | 100 | 600 | 702,84 |
| WDT-10120 | 10 | 120 | 9,2 | 50 | 60 | 8 | 22 | 100 | 400 | 849,09 |
| WDT-10140 | 10 | 140 | 9,2 | 50 | 60 | 8 | 20 | 100 | 400 | 1 020,88 |
| WDT-10160 | 10 | 160 | 9,2 | 50 | 60 | 8 | 15 | 100 | 400 | 1 290,28 |
| WDT-10180 | 10 | 180 | 9,2 | 50 | 60 | 8 | 12 | 100 | 300 | 1 429,70 |
| WDT-10200 | 10 | 200 | 9,2 | 50 | 60 | 8 | 11 | 100 | 300 | 1 560,66 |

Pręt gwintowany ze stali nierdzewnej A2

Threaded rod



| INDEX | ROZMIAR SIZE [mm] M x L | ILOŚĆ [szt.] QUANTITY [pcs] | | WAGA / WEIGHT 100 szt./pcs [kg] | CENA / PRICE 1 szt./pcs [PLN] |
|------------|-------------------------------|--------------------------------|------|---------------------------------------|-------------------------------------|
| | | | | | |
| PRIA-05100 | M5 x 1000 | 100 | 9000 | 12,3 | 8,29 |
| PRIA-06100 | M6 x 1000 | 100 | 6000 | 16,9 | 10,13 |
| PRIA-08100 | M8 x 1000 | 50 | 3000 | 31,2 | 14,17 |
| PRIA-10100 | M10 x 1000 | 50 | 3000 | 49,8 | 21,07 |
| PRIA-12100 | M12 x 1000 | 20 | 1500 | 71,4 | 31,21 |
| PRIA-14100 | M14 x 1000 | 10 | 1000 | 99,4 | 40,79 |
| PRIA-16100 | M16 x 1000 | 10 | 750 | 131,2 | 57,69 |
| PRIA-20100 | M20 x 1000 | 5 | 600 | 210,0 | 90,20 |

Pręt gwintowany czarny i ocynkowany

Threaded rod

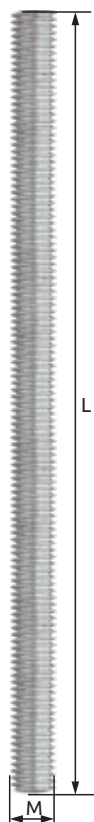

| INDEX | ROZMIAR SIZE [mm] M x L | ILOŚĆ [szt.] QUANTITY [pcs] | | WAGA / WEIGHT 100 szt./pcs [kg] | CENA / PRICE 1 szt./pcs [PLN] | |
|-----------|-------------------------------|--------------------------------|------|---------------------------------------|------------------------------------|------------|
| | | | | | CZARNA/BLACK | OCYNK/ZINC |
| PRI-03100 | M3 x 1000 | 100 | 9000 | 4,0 | | 1,23 |
| PRI-04100 | M4 x 1000 | 100 | 9000 | 7,0 | | 1,59 |
| PRI-05100 | M5 x 1000 | 100 | 9000 | 11,0 | | 1,75 |
| PRI-06100 | M6 x 1000 | 100 | 7900 | 15,1 | 1,67 | 1,86 |
| PRI-08100 | M8 x 1000 | 50 | 4600 | 26,0 | 2,73 | 2,91 |
| PRI-10100 | M10 x 1000 | 25 | 2900 | 41,5 | 4,31 | 4,56 |
| PRI-12100 | M12 x 1000 | 20 | 1900 | 61,7 | 6,26 | 6,53 |
| PRI-14100 | M14 x 1000 | 10 | 1300 | 89,0 | 8,97 | 9,37 |
| PRI-16100 | M16 x 1000 | 10 | 1000 | 120,0 | 12,28 | 12,82 |
| PRI-18100 | M18 x 1000 | 10 | 770 | 154,0 | 15,68 | 16,11 |
| PRI-20100 | M20 x 1000 | 5 | 610 | 194,0 | 19,96 | 20,86 |
| PRI-22100 | M22 x 1000 | 5 | 490 | 242,0 | | 25,97 |
| PRI-24100 | M24 x 1000 | 5 | 420 | 280,0 | 28,69 | 30,61 |
| PRI-27100 | M27 x 1000 | 5 | 320 | 365,0 | | 45,63 |
| PRI-30100 | M30 x 1000 | 1 | 260 | 456,0 | | 57,54 |
| PRI-33100 | M33 x 1000 | 1 | 200 | 577,0 | | 71,06 |
| PRI-36100 | M36 x 1000 | 1 | 170 | 677,0 | | 84,05 |
| PRI-42100 | M42 x 1000 | 1 | 120 | 936,0 | | 118,68 |
| PRI-06200 | M6 x 2000 | 50 | 3900 | 30,2 | | 4,12 |
| PRI-08200 | M8 x 2000 | 25 | 2300 | 52,0 | | 6,56 |
| PRI-10200 | M10 x 2000 | 25 | 1450 | 83,0 | | 10,22 |
| PRI-12200 | M12 x 2000 | 10 | 980 | 123,4 | | 14,31 |
| PRI-14200 | M14 x 2000 | 10 | 670 | 178,0 | | 20,01 |
| PRI-16200 | M16 x 2000 | 10 | 500 | 240, | | 28,91 |
| PRI-20200 | M20 x 2000 | 5 | 300 | 388,0 | | 47,05 |
| PRI-24200 | M24 x 2000 | 5 | 210 | 560,0 | | 65,74 |
| PRI-30200 | M30 x 2000 | 5 | 130 | 874,0 | | 112,23 |
| PRI-06300 | M6 x 3000 | 10 | 2600 | 45,3 | | 7,42 |
| PRI-08300 | M8 x 3000 | 10 | 1500 | 78,0 | | 11,74 |
| PRI-10300 | M10 x 3000 | 10 | 970 | 124,5 | | 18,18 |
| PRI-12300 | M12 x 3000 | 10 | 650 | 185,1 | | 25,97 |

Pręt gwintowany ocynkowany kl. 8.8

Threaded rod



| INDEX | ROZMIAR SIZE [mm] M x L | ILOŚĆ [szt.] QUANTITY [pcs] | | WAGA / WEIGHT 100 szt./pcs [kg] | CENA / PRICE 1 szt./pcs [PLN] |
|------------|-------------------------------|--------------------------------|------|---------------------------------------|---------------------------------------|
| | | | | | |
| PRI-061008 | M6 x 1000 | 100 | 6000 | 16,9 | 3,03 |
| PRI-081008 | M8 x 1000 | 50 | 3000 | 31,2 | 5,12 |
| PRI-101008 | M10 x 1000 | 25 | 2000 | 49,8 | 7,89 |
| PRI-121008 | M12 x 1000 | 20 | 1500 | 71,4 | 11,20 |
| PRI-141008 | M14 x 1000 | 10 | 1000 | 99,4 | 15,58 |
| PRI-161008 | M16 x 1000 | 10 | 750 | 131,2 | 20,56 |
| PRI-181008 | M18 x 1000 | 10 | 600 | 165,0 | 25,85 |
| PRI-201008 | M20 x 1000 | 5 | 500 | 205,3 | 32,67 |
| PRI-221008 | M22 x 1000 | 5 | 490 | 242,0 | 40,27 |
| PRI-241008 | M24 x 1000 | 5 | 300 | 296,0 | 46,89 |
| PRI-271008 | M27 x 1000 | 5 | 300 | 373,0 | 61,14 |
| PRI-301008 | M30 x 1000 | 1 | 200 | 469,0 | 76,98 |
| PRI-331008 | M33 x 1000 | 1 | 180 | 577,0 | 94,63 |
| PRI-361008 | M36 x 1000 | 1 | 150 | 677,0 | 112,83 |
| PRI-421008 | M42 x 1000 | 1 | 100 | 936,0 | 154,67 |
| PRI-082008 | M8 x 2000 | 25 | 1500 | 62,4 | 10,23 |
| PRI-102008 | M10 x 2000 | 25 | 1000 | 99,6 | 15,77 |
| PRI-122008 | M12 x 2000 | 10 | 750 | 142,8 | 22,39 |
| PRI-162008 | M16 x 2000 | 10 | 400 | 262,4 | 41,13 |
| PRI-202008 | M20 x 2000 | 5 | 250 | 410,6 | 65,32 |
| PRI-242008 | M24 x 2000 | 5 | 150 | 592,0 | 93,77 |
| PRI-302008 | M30 x 2000 | 5 | 100 | 938,00 | 153,96 |

Łącznik śrubowy odgięty - TYP L - czarny

T-rod l-type

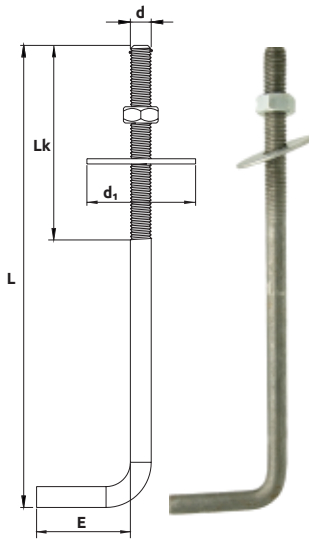

| INDEX | ROZMIAR / SIZE [mm] | | | | | ILOŚĆ [szt.] QUANTITY [pcs] | CENA / PRICE 1 szt./pcs [PLN] |
|-----------|---------------------|-----|----|----|----------------|--------------------------------|-------------------------------------|
| | d | L | Lk | E | d ₁ | | |
| KML-12250 | M12 | 250 | 80 | 50 | 45 | 20 | 4,10 |
| KML-12300 | M12 | 300 | 80 | 50 | 45 | 20 | 4,63 |
| KML-12350 | M12 | 350 | 80 | 50 | 45 | 20 | 5,15 |
| KML-12400 | M12 | 400 | 80 | 50 | 45 | 20 | 5,66 |
| KML-12450 | M12 | 450 | 80 | 50 | 45 | 20 | 6,28 |
| KML-12500 | M12 | 500 | 80 | 50 | 45 | 20 | 6,77 |
| KML-14250 | M14 | 250 | 80 | 50 | 45 | 20 | 5,43 |
| KML-14300 | M14 | 300 | 80 | 50 | 45 | 20 | 6,18 |
| KML-14350 | M14 | 350 | 80 | 50 | 45 | 20 | 6,88 |
| KML-14400 | M14 | 400 | 80 | 50 | 45 | 20 | 7,58 |
| KML-14450 | M14 | 450 | 80 | 50 | 45 | 20 | 8,28 |
| KML-14500 | M14 | 500 | 80 | 50 | 45 | 20 | 9,00 |
| KML-16300 | M16 | 300 | 80 | 50 | 45 | 20 | 8,35 |
| KML-16350 | M16 | 350 | 80 | 50 | 45 | 20 | 9,28 |
| KML-16400 | M16 | 400 | 80 | 50 | 45 | 20 | 10,27 |
| KML-16450 | M16 | 450 | 80 | 50 | 45 | 20 | 11,20 |
| KML-16500 | M16 | 500 | 80 | 50 | 45 | 20 | 12,15 |

Łącznik śrubowy odgięty - TYP L - ocynkowany

T-rod l-type

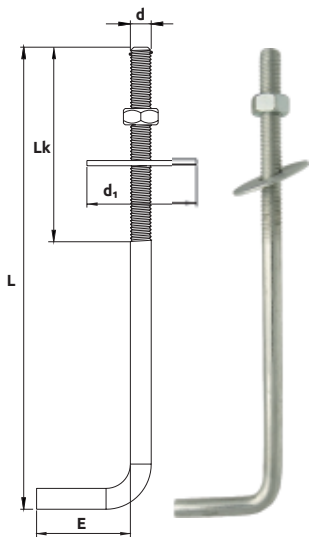

| INDEX | ROZMIAR / SIZE [mm] | | | | | ILOŚĆ [szt.] QUANTITY [pcs] | CENA / PRICE 1 szt./pcs [PLN] |
|------------|---------------------|-----|----|----|----------------|--------------------------------|-------------------------------------|
| | d | L | Lk | E | d ₁ | | |
| KMLO-12250 | M12 | 250 | 80 | 50 | 45 | 20 | 4,94 |
| KMLO-12300 | M12 | 300 | 80 | 50 | 45 | 20 | 5,35 |
| KMLO-12350 | M12 | 350 | 80 | 50 | 45 | 20 | 5,94 |
| KMLO-12400 | M12 | 400 | 80 | 50 | 45 | 20 | 6,68 |
| KMLO-12450 | M12 | 450 | 80 | 50 | 45 | 20 | 7,41 |
| KMLO-12500 | M12 | 500 | 80 | 50 | 45 | 20 | 8,80 |
| KMLO-14250 | M14 | 250 | 80 | 50 | 45 | 20 | 6,32 |
| KMLO-14300 | M14 | 300 | 80 | 50 | 45 | 20 | 7,20 |
| KMLO-14350 | M14 | 350 | 80 | 50 | 45 | 20 | 8,05 |
| KMLO-14400 | M14 | 400 | 80 | 50 | 45 | 20 | 9,02 |
| KMLO-14450 | M14 | 450 | 80 | 50 | 45 | 20 | 9,88 |
| KMLO-14500 | M14 | 500 | 80 | 50 | 45 | 20 | 10,88 |
| KMLO-16300 | M16 | 300 | 80 | 50 | 45 | 20 | 9,73 |
| KMLO-16350 | M16 | 350 | 80 | 50 | 45 | 20 | 10,77 |
| KMLO-16400 | M16 | 400 | 80 | 50 | 45 | 20 | 12,17 |
| KMLO-16450 | M16 | 450 | 80 | 50 | 45 | 20 | 13,34 |
| KMLO-16500 | M16 | 500 | 80 | 50 | 45 | 20 | 14,68 |

Hak huśtawkowy

Hook pigtail

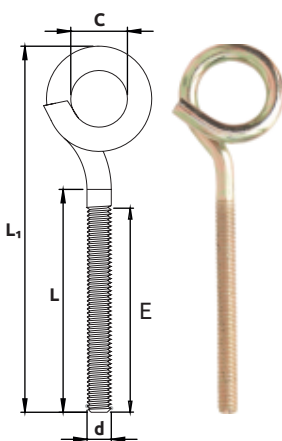

| INDEX | d | ROZMIAR SIZE [mm] | | | E | C | ILOŚĆ [szt.] QUANTITY [pcs] | CENA / PRICE 1 szt./pcs [PLN] |
|-----------|-----|----------------------|----------------|-----|------|----|--------------------------------|-------------------------------------|
| | | L | L ₁ | | | | | |
| HHH-06050 | M6 | 50 | 84 | 40 | 17,2 | 50 | 0,86 | |
| HHH-06065 | M6 | 65 | 100 | 55 | 17,2 | 50 | 0,95 | |
| HHH-06080 | M6 | 80 | 115 | 70 | 17,2 | 25 | 1,00 | |
| HHH-06100 | M6 | 100 | 135 | 90 | 17,2 | 25 | 1,08 | |
| HHH-06150 | M6 | 150 | 185 | 140 | 17,2 | 10 | 1,41 | |
| HHH-08080 | M8 | 80 | 134 | 70 | 32,0 | 25 | 2,00 | |
| HHH-08100 | M8 | 100 | 156 | 90 | 32,0 | 25 | 2,15 | |
| HHH-08120 | M8 | 120 | 175 | 110 | 32,0 | 25 | 2,40 | |
| HHH-08160 | M8 | 160 | 214 | 150 | 32,0 | 10 | 2,71 | |
| HHH-10100 | M10 | 100 | 165 | 90 | 33,0 | 25 | 3,69 | |
| HHH-10120 | M10 | 120 | 185 | 110 | 33,0 | 10 | 3,97 | |
| HHH-10200 | M10 | 200 | 260 | 190 | 33,0 | 10 | 4,80 | |
| HHH-12200 | M12 | 200 | 265 | 180 | 37,0 | 10 | 7,52 | |

Hak oczkowy zamknięty HHZ

Hook O-type

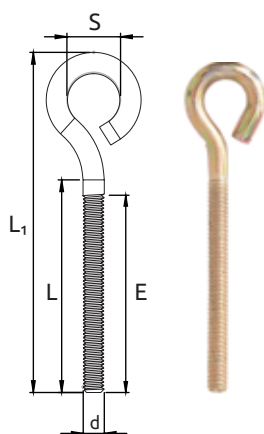

| INDEX | ROZMIAR SIZE [mm] | | | | | ILOŚĆ [szt.] QUANTITY [pcs] | CENA / PRICE 1 szt./pcs [PLN] |
|-----------|----------------------|-----|----------------|-----|------|--------------------------------|-------------------------------------|
| | d | L | L ₁ | E | S | | |
| HHZ-06050 | M6 | 50 | 77 | 40 | 13,6 | 50 | 0,49 |
| HHZ-06060 | M6 | 60 | 87 | 50 | 13,6 | 50 | 0,55 |
| HHZ-06080 | M6 | 80 | 107 | 70 | 13,6 | 25 | 0,65 |
| HHZ-06100 | M6 | 100 | 127 | 90 | 13,6 | 25 | 0,77 |
| HHZ-06130 | M6 | 130 | 157 | 120 | 13,6 | 10 | 0,92 |
| HHZ-06150 | M6 | 150 | 177 | 140 | 13,6 | 10 | 1,01 |
| HHZ-08050 | M8 | 50 | 84 | 40 | 15,8 | 50 | 0,95 |
| HHZ-08060 | M8 | 60 | 94 | 50 | 15,8 | 50 | 1,05 |
| HHZ-08100 | M8 | 100 | 134 | 90 | 15,8 | 25 | 1,41 |
| HHZ-08150 | M8 | 150 | 184 | 140 | 15,8 | 25 | 1,85 |
| HHZ-08160 | M8 | 160 | 194 | 150 | 15,8 | 10 | 1,94 |
| HHZ-08180 | M8 | 180 | 214 | 170 | 15,8 | 10 | 2,09 |
| HHZ-10050 | M10 | 50 | 93 | 40 | 19,7 | 50 | 1,72 |
| HHZ-10060 | M10 | 60 | 103 | 50 | 19,7 | 50 | 1,85 |
| HHZ-10080 | M10 | 80 | 123 | 70 | 19,7 | 25 | 2,15 |
| HHZ-10100 | M10 | 100 | 143 | 90 | 19,7 | 25 | 2,34 |
| HHZ-10120 | M10 | 120 | 163 | 110 | 19,7 | 10 | 2,71 |
| HHZ-10150 | M10 | 150 | 193 | 140 | 19,7 | 10 | 3,08 |
| HHZ-10180 | M10 | 180 | 223 | 170 | 19,7 | 10 | 3,69 |
| HHZ-10200 | M10 | 200 | 243 | 190 | 19,7 | 10 | 3,95 |

Hak zagięty otwarty HHO

Hook C-type

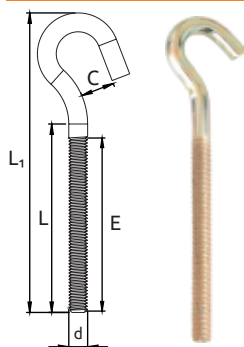

| INDEX | ROZMIAR SIZE [mm] | | | | | ILOŚĆ [szt.] QUANTITY [pcs] | CENA / PRICE 1 szt./pcs [PLN] |
|-----------|----------------------|-----|----------------|-----|-----|--------------------------------|-------------------------------------|
| | d | L | L ₁ | E | C | | |
| HHO-06050 | M6 | 50 | 77 | 40 | 5,2 | 50 | 0,52 |
| HHO-06060 | M6 | 60 | 87 | 50 | 5,2 | 50 | 0,55 |
| HHO-06080 | M6 | 80 | 107 | 70 | 5,2 | 25 | 0,58 |
| HHO-08050 | M8 | 50 | 84 | 40 | 7,0 | 50 | 0,86 |
| HHO-08060 | M8 | 60 | 94 | 50 | 7,0 | 50 | 0,95 |
| HHO-08100 | M8 | 100 | 134 | 90 | 7,0 | 25 | 1,32 |
| HHO-08160 | M8 | 160 | 194 | 150 | 7,0 | 25 | 1,81 |
| HHO-08180 | M8 | 180 | 214 | 170 | 7,0 | 25 | 2,04 |
| HHO-10120 | M10 | 120 | 163 | 110 | 8,7 | 25 | 2,40 |
| HHO-10180 | M10 | 180 | 223 | 170 | 8,7 | 25 | 3,20 |

Hak zagięty prosty HHP

Hook square

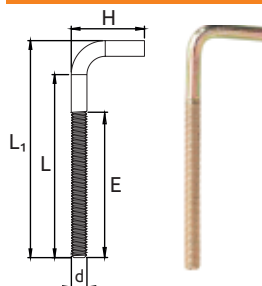

| INDEX | ROZMIAR SIZE [mm] | | | | | ILOŚĆ [szt.] QUANTITY [pcs] | CENA / PRICE 1 szt./pcs [PLN] |
|-----------|----------------------|-----|----------------|-----|----|--------------------------------|-------------------------------------|
| | d | L | L ₁ | E | H | | |
| HHP-06070 | M6 | 70 | 75 | 50 | 20 | 50 | 0,52 |
| HHP-08070 | M8 | 70 | 77 | 50 | 23 | 50 | 0,92 |
| HHP-08080 | M8 | 80 | 87 | 60 | 23 | 50 | 0,98 |
| HHP-08160 | M8 | 160 | 167 | 130 | 26 | 25 | 1,75 |
| HHP-10100 | M10 | 100 | 109 | 80 | 30 | 25 | 2,00 |
| HHP-10160 | M10 | 160 | 169 | 140 | 30 | 25 | 2,68 |
| HHP-10180 | M10 | 180 | 189 | 160 | 30 | 25 | 3,04 |

Śruba lemieszowa / płuzna

Plow Bolt



| INDEX | ROZMIAR SIZE [mm] | ILOŚĆ [kg] QUANTITY [kg] | CENA / PRICE 1 kg [PLN] |
|----------|----------------------|-----------------------------|-------------------------------|
| | | | |
| ŚL-10030 | 10 x 30 | 20 | 24,85 |
| ŚL-10035 | 10 x 35 | 20 | 24,85 |
| ŚL-10040 | 10 x 40 | 20 | 24,85 |
| ŚL-10045 | 10 x 45 | 20 | 24,85 |
| ŚL-12030 | 12 x 30 | 20 | 24,85 |
| ŚL-12035 | 12 x 35 | 20 | 24,85 |
| ŚL-12040 | 12 x 40 | 20 | 24,85 |
| ŚL-12045 | 12 x 45 | 20 | 24,85 |
| ŚL-12050 | 12 x 50 | 20 | 24,85 |
| ŚL-12060 | 12 x 60 | 20 | 24,85 |

Podkładka okrągła, zgrubna - ocynkowana Round washer

PN-82005 / DIN 125A

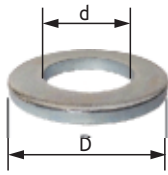

| INDEX | M | d [mm] | D [mm] | WAGA 1000 szt. WEIGHT 1000 pcs [kg] | ILOŚĆ [szt./kg] QUANTITY [pcs/kg] | ILOŚĆ [kg] QUANTITY [kg] | CENA / PRICE 1 kg [PLN] | |
|--------|-----|--------|--------|---|--------------------------------------|-----------------------------|-------------------------------|-------|
| POD-03 | M3 | 3,2 | 7,0 | 0,12 | 8403 | 5 | 20 | 29,85 |
| POD-04 | M4 | 4,3 | 9,0 | 0,31 | 3247 | 5 | 20 | 22,15 |
| POD-05 | M5 | 5,3 | 10,0 | 0,44 | 2257 | 5 | 20 | 20,77 |
| POD-06 | M6 | 6,4 | 12,0 | 1,02 | 980 | 5 | 20 | 19,70 |
| POD-08 | M8 | 8,4 | 16,0 | 1,83 | 546 | 5 | 20 | 18,15 |
| POD-10 | M10 | 10,5 | 20,0 | 3,57 | 280 | 5 | 20 | 17,84 |
| POD-12 | M12 | 13,0 | 24,0 | 6,27 | 159 | 5 | 20 | 16,77 |
| POD-14 | M14 | 15,0 | 28,0 | 8,62 | 116 | 5 | 20 | 16,77 |
| POD-16 | M16 | 17,0 | 30,0 | 11,3 | 88 | 5 | 20 | 16,77 |
| POD-18 | M18 | 19,0 | 34,0 | 14,7 | 68 | 5 | 20 | 16,77 |
| POD-20 | M20 | 21,0 | 37,0 | 17,2 | 58 | 5 | 20 | 16,77 |
| POD-22 | M22 | 23,0 | 39,0 | 18,3 | 55 | 5 | 20 | 17,23 |
| POD-24 | M24 | 25,0 | 44,0 | 32,3 | 31 | 5 | 20 | 17,23 |
| POD-27 | M27 | 28,0 | 50,0 | 42,3 | 24 | 5 | 20 | 17,23 |
| POD-30 | M30 | 31,0 | 56,0 | 53,6 | 19 | 5 | 20 | 17,85 |

Podkładka okrągła, poszerzona - ocynkowana Enlarged round washer

PN-82030 / DIN 9021

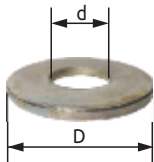

| INDEX | M | d [mm] | D [mm] | WAGA 1000 szt. WEIGHT 1000 pcs [kg] | ILOŚĆ [szt./kg] QUANTITY [pcs/kg] | ILOŚĆ [kg] QUANTITY [kg] | CENA / PRICE 1 kg [PLN] | |
|----------|-----|--------|--------|---|--------------------------------------|-----------------------------|-------------------------------|-------|
| POP-3004 | M4 | 4,3 | 12,0 | 0,77 | 1292 | 5 | 20 | 20,31 |
| POP-3005 | M5 | 5,3 | 15,0 | 1,46 | 685 | 5 | 20 | 17,76 |
| POP-3006 | M6 | 6,4 | 18,0 | 2,79 | 358 | 5 | 20 | 17,23 |
| POP-3008 | M8 | 8,4 | 24,0 | 6,23 | 161 | 5 | 20 | 16,46 |
| POP-3010 | M10 | 10,5 | 30,0 | 12,2 | 82 | 5 | 20 | 16,15 |
| POP-3012 | M12 | 13,0 | 37,0 | 22,2 | 45 | 5 | 20 | 16,15 |
| POP-3014 | M14 | 15,0 | 44,0 | 31,6 | 32 | 5 | 20 | 16,15 |
| POP-3016 | M16 | 17,0 | 50,0 | 40,9 | 24 | 5 | 20 | 16,15 |
| POP-3018 | M18 | 19,0 | 56,0 | 67,4 | 15 | 5 | 20 | 16,15 |
| POP-3020 | M20 | 21,0 | 60,0 | 76,8 | 13 | 5 | 20 | 16,15 |
| POP-3022 | M22 | 23,0 | 66,0 | 89,8 | 11 | 5 | 20 | 16,46 |
| POP-3024 | M24 | 25,0 | 72,0 | 139,0 | 7 | 5 | 20 | 16,46 |
| POP-3027 | M27 | 30,0 | 85,0 | 175,0 | 6 | 5 | 20 | 16,46 |
| POP-3030 | M30 | 33,0 | 92,0 | 273,0 | 4 | 5 | 20 | 17,07 |

Podkładka okrągła, poszerzona - ocynkowana Enlarged round washer

PN-82019 / DIN 440R

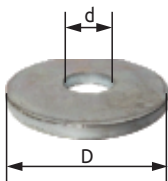

| INDEX | M | d [mm] | D [mm] | WAGA 1000 szt. WEIGHT 1000 pcs [kg] | ILOŚĆ [szt./kg] QUANTITY [pcs/kg] | ILOŚĆ [kg] QUANTITY [kg] | CENA / PRICE 1 kg [PLN] | |
|----------|-----|--------|--------|---|--------------------------------------|-----------------------------|-------------------------------|-------|
| POP-1904 | M4 | 4,5 | 13,9 | 1,7 | 574 | 5 | 20 | 20,31 |
| POP-1905 | M5 | 5,6 | 17,8 | 3,6 | 276 | 5 | 20 | 17,76 |
| POP-1906 | M6 | 6,6 | 21,7 | 5,4 | 184 | 5 | 20 | 17,23 |
| POP-1908 | M8 | 9,2 | 26,8 | 13,0 | 77 | 5 | 20 | 16,46 |
| POP-1910 | M10 | 11,1 | 33,7 | 19,1 | 52 | 5 | 20 | 16,15 |
| POP-1912 | M12 | 13,4 | 42,2 | 43,3 | 23 | 5 | 20 | 16,15 |
| POP-1914 | M14 | 15,6 | 49,6 | 55,7 | 18 | 5 | 20 | 16,15 |
| POP-1916 | M16 | 17,7 | 54,7 | 87,2 | 11 | 5 | 20 | 16,15 |
| POP-1918 | M18 | 19,5 | 62,0 | 114,6 | 9 | 5 | 20 | 16,15 |
| POP-1920 | M20 | 22,5 | 70,4 | 174,0 | 6 | 5 | 20 | 16,15 |
| POP-1922 | M22 | 24,0 | 80,0 | 215,0 | 5 | 5 | 20 | 16,46 |
| POP-1924 | M24 | 24,5 | 85,0 | 242,0 | 4 | 5 | 20 | 16,46 |
| POP-1927 | M27 | 30,0 | 98,0 | 322,0 | 3 | 5 | 20 | 16,46 |
| POP-1930 | M30 | 33,0 | 105,0 | 368,0 | 3 | 5 | 20 | 17,07 |

Podkładka sprężysta - ocynkowana

Spring washer

PN-82008 / DIN 127B

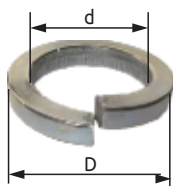

| INDEX | M | d [mm] | D [mm] | WAGA 1000 szt. / WEIGHT 1000 pcs [kg] | ILOŚĆ [szt./kg] / QUANTITY [pcs/kg] | ILOŚĆ [kg] / QUANTITY [kg] | CENA / PRICE 1 kg [PLN] | |
|---------|-----|--------|--------|---------------------------------------|-------------------------------------|----------------------------|-------------------------|-------|
| PODS-03 | M3 | 3,1 | 4,3 | 0,11 | 9091 | 5 | 20 | 34,30 |
| PODS-04 | M4 | 4,2 | 6,2 | 0,18 | 5556 | 5 | 20 | 27,84 |
| PODS-05 | M5 | 5,2 | 8,8 | 0,36 | 2778 | 5 | 20 | 24,46 |
| PODS-06 | M6 | 6,2 | 11,3 | 0,83 | 1205 | 5 | 20 | 22,15 |
| PODS-08 | M8 | 8,2 | 14,0 | 1,60 | 625 | 5 | 20 | 20,77 |
| PODS-10 | M10 | 10,2 | 17,4 | 2,53 | 395 | 5 | 20 | 20,34 |
| PODS-12 | M12 | 12,2 | 20,3 | 3,82 | 262 | 5 | 20 | 20,34 |
| PODS-14 | M14 | 14,5 | 23,5 | 6,01 | 166 | 5 | 20 | 20,34 |
| PODS-16 | M16 | 16,6 | 26,5 | 8,91 | 112 | 5 | 20 | 20,34 |
| PODS-18 | M18 | 18,6 | 29,4 | 9,80 | 102 | 5 | 20 | 20,34 |
| PODS-20 | M20 | 20,8 | 32,6 | 15,20 | 66 | 5 | 20 | 21,38 |
| PODS-24 | M24 | 25,6 | 39,6 | 26,20 | 38 | 5 | 20 | 21,38 |
| PODS-30 | M30 | 31,4 | 56,0 | 44,30 | 23 | 5 | 20 | 21,70 |

Podkładka kwadratowa do konstrukcji drewnianych - ocynkowana

Wood construction washer

DIN 436



| INDEX | M | d [mm] | D [mm] | WAGA 1000 szt. / WEIGHT 1000 pcs [kg] | ILOŚĆ [szt./kg] / QUANTITY [pcs/kg] | ILOŚĆ [kg] / QUANTITY [kg] | CENA / PRICE 1 kg [PLN] | |
|--------|-----|--------|--------|---------------------------------------|-------------------------------------|----------------------------|-------------------------|-------|
| POK-10 | M10 | 12,0 | 30,0 | 20,0 | 50 | 5 | 20 | 16,15 |
| POK-12 | M12 | 14,0 | 40,0 | 45,7 | 22 | 5 | 20 | 16,15 |
| POK-14 | M14 | 16,0 | 40,0 | 51,2 | 19 | 5 | 20 | 16,15 |
| POK-16 | M16 | 18,0 | 50,0 | 88,7 | 11 | 5 | 20 | 16,15 |
| POK-18 | M18 | 20,0 | 50,0 | 97,7 | 10 | 5 | 20 | 16,15 |
| POK-20 | M20 | 22,0 | 60,0 | 126,0 | 8 | 5 | 20 | 16,15 |
| POK-24 | M24 | 26,0 | 70,0 | 275,0 | 4 | 5 | 20 | 16,15 |

Podkładka do gwoździ papowych

Washer for nails



| INDEX | ROZMIAR / SIZE [mm] | KOLOR / COLOR | ILOŚĆ / QUANTITY [kg] | CENA / PRICE 1 kg [PLN] | |
|--------|---------------------|---------------|-----------------------|-------------------------|-------|
| PODPAP | ø26 | ocynk / zinc | 5 | 20 | 18,38 |

Nakrętka złączna ocynkowana

Coupling nut

DIN 6334

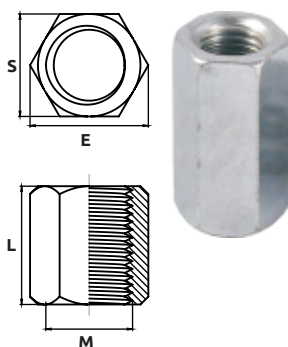

| INDEX | ROZMIAR / SIZE [mm] | | | | WAGA / WEIGHT 1000 szt./pcs [kg] | ILOŚĆ [szt.] / QUANTITY [pcs] | CENA / PRICE 1 szt./pcs [PLN] |
|-------|---------------------|----|----|-------|----------------------------------|-------------------------------|-------------------------------|
| | M | L | S | E | | | |
| NZ-04 | M4 | 12 | 7 | 7,80 | 6,0 | 300 | 0,20 |
| NZ-05 | M5 | 15 | 8 | 8,79 | 7,0 | 300 | 0,21 |
| NZ-06 | M6 | 18 | 10 | 11,05 | 8,1 | 250 | 0,22 |
| NZ-08 | M8 | 24 | 13 | 15,00 | 13,2 | 100 | 0,40 |
| NZ-10 | M10 | 30 | 17 | 19,60 | 22,7 | 50 | 0,85 |
| NZ-12 | M12 | 36 | 19 | 21,90 | 45,0 | 50 | 1,20 |
| NZ-14 | M14 | 42 | 22 | 24,50 | 88,0 | 25 | 1,93 |
| NZ-16 | M16 | 48 | 24 | 27,70 | 107,5 | 25 | 2,43 |
| NZ-18 | M18 | 54 | 27 | 31,20 | 140,0 | 25 | 4,37 |
| NZ-20 | M20 | 60 | 30 | 34,00 | 188,5 | 25 | 5,15 |
| NZ-22 | M22 | 66 | 32 | 35,70 | 260,0 | 25 | 6,57 |
| NZ-24 | M24 | 72 | 36 | 41,60 | 333,0 | 25 | 9,22 |
| NZ-30 | M30 | 90 | 46 | 50,85 | 500,0 | 25 | 26,05 |

Nakrętka pazurkowa - ocynkowana

T-nut

DIN 1624



| INDEX | ROZMIAR SIZE [mm] | OPAKOWANIE [szt.] PACKAGE [pcs] | ILOŚĆ [kg] QUANTITY [kg] | | CENA / PRICE 1000 szt./pcs [PLN] |
|----------|----------------------|------------------------------------|-----------------------------|----|--|
| | | | | | |
| NAKP0609 | M6 x 9 | 100 | 5 | 20 | 102,00 |
| NAKP0612 | M6 x 12 | 100 | 5 | 20 | 120,00 |
| NAKP0811 | M8 x 11 | 50 | 5 | 20 | 152,00 |

Nakrętka sześciokątna - ocynkowana

Metric hexagon nut zinc

DIN 934

| Klasa 4 | | | | Klasa 8 | | | |
|---------|-------|-------------------------------------|-------------------------------|---------|-------|-------------------------------------|-------------------------------|
| INDEX | M | SZTUK / KG QUANTITY / KG 1 kg | CENA / PRICE 1 kg [PLN] | INDEX | M | SZTUK / KG QUANTITY / KG 1 kg | CENA / PRICE 1 kg [PLN] |
| NAK-03 | M3 | 1648 | 21,08 | NAK8-06 | M6 | 400 | 16,52 |
| NAK-04 | M4 | 1235 | 18,46 | NAK8-08 | M8 | 192 | 16,23 |
| NAK-05 | M5 | 813 | 14,63 | NAK8-10 | M10 | 86 | 16,23 |
| NAK-06 | M6 | 400 | 12,06 | NAK8-12 | M12 | 58 | 16,23 |
| NAK-08 | M8 | 192 | 11,83 | NAK8-14 | M14 | 40 | 16,23 |
| NAK-10 | M10 | 86 | 11,83 | NAK8-16 | M16 | 30 | 16,23 |
| NAK-12 | M12 | 58 | 11,83 | NAK8-18 | M18 | 20,2 | 16,41 |
| NAK-14 | M14 | 40 | 11,83 | NAK8-20 | M20 | 15,5 | 16,41 |
| NAK-16 | M16 | 30 | 11,83 | NAK8-22 | M22 | 12,7 | 16,73 |
| NAK-18 | M18 | 20,2 | 11,98 | NAK8-24 | M24 | 9,1 | 16,73 |
| NAK-20 | M20 | 15,5 | 12,97 | NAK8-27 | M27 | 6,1 | 16,95 |
| NAK-22 | M22 | 12,7 | 12,97 | NAK8-30 | M30 | 4,5 | 16,95 |
| NAK-24 | M24 | 9,1 | 12,97 | NAK8-36 | M36 | 2,5 | 18,89 |
| NAK-27 | M27 | 6,1 | 13,23 | | | | |
| NAK-30 | M30 | 4,5 | 13,69 | | | | |
| NAK-33 | M33 | 3,5 | 14,23 | | | | |
| NAK-36 | M36 | 2,5 | 14,23 | | | | |



Nakrętka sześciokątna - czarna

Metric hexagon nut plain

DIN 934

| Klasa 4 | | | |
|---------|-------|-------------------------------------|-------------------------------|
| INDEX | M | SZTUK / KG QUANTITY / KG 1 kg | CENA / PRICE 1 kg [PLN] |
| NAKC-06 | M6 | 400 | 11,78 |
| NAKC-08 | M8 | 192 | 11,46 |
| NAKC-10 | M10 | 86 | 11,46 |
| NAKC-12 | M12 | 58 | 11,46 |
| NAKC-14 | M14 | 40 | 11,46 |
| NAKC-16 | M16 | 30 | 11,46 |
| NAKC-20 | M20 | 20,2 | 12,58 |
| NAKC-22 | M22 | 15,5 | 12,58 |
| NAKC-24 | M24 | 12,7 | 12,58 |
| NAKC-27 | M27 | 9,1 | 12,92 |



Nakrętka samokontrująca ocynkowana z wkładką poliamidową

Plain nylon insert lock nut

DIN 985



| INDEX | M | CENA / PRICE 1000 szt./pcs [PLN] |
|----------|-------|--|
| NAKWK-03 | M3 | 27,69 |
| NAKWK-04 | M4 | 31,53 |
| NAKWK-05 | M5 | 34,15 |
| NAKWK-06 | M6 | 44,46 |
| NAKWK-08 | M8 | 88,46 |
| NAKWK-10 | M10 | 192,31 |
| NAKWK-12 | M12 | 275,69 |
| NAKWK-14 | M14 | 425,23 |
| NAKWK-16 | M16 | 576,92 |
| NAKWK-18 | M18 | 921,15 |
| NAKWK-20 | M20 | 1 152,77 |
| NAKWK-24 | M24 | 2 240,00 |
| NAKWK-30 | M30 | 4 718,00 |

Nakrętka kotłowa - ocynkowana

Hexagonal domed cap nut

DIN 1587



| INDEX | M | CENA / PRICE 1000 szt./pcs [PLN] |
|---------|-------|--|
| NAKK-04 | M4 | 64,60 |
| NAKK-05 | M5 | 76,90 |
| NAKK-06 | M6 | 101,50 |
| NAKK-08 | M8 | 203,10 |
| NAKK-10 | M10 | 332,30 |
| NAKK-12 | M12 | 447,70 |
| NAKK-14 | M14 | 846,15 |
| NAKK-16 | M16 | 1 006,15 |
| NAKK-20 | M20 | 2 538,50 |

Nakrętka kotłowa - ocynkowana

Hexagonal flange nut

DIN 6923



| INDEX | M | CENA / PRICE 1000 szt./pcs [PLN] |
|---------|-------|--|
| NAKZ-04 | M4 | 39,00 |
| NAKZ-06 | M5 | 44,82 |
| NAKZ-08 | M6 | 66,46 |
| NAKZ-05 | M8 | 137,33 |
| NAKZ-10 | M10 | 207,69 |
| NAKZ-12 | M12 | 376,92 |
| NAKZ-16 | M16 | 1 021,18 |

Nakrętka motylkowa - ocynkowana

Wing nut

DIN 315



| INDEX | M | CENA / PRICE 1000 szt./pcs [PLN] |
|--------|-------|--|
| NAM-03 | M3 | 92,30 |
| NAM-04 | M4 | 100,00 |
| NAM-05 | M5 | 106,15 |
| NAM-06 | M6 | 136,90 |
| NAM-08 | M8 | 193,80 |
| NAM-10 | M10 | 298,50 |
| NAM-12 | M12 | 492,30 |
| NAM-14 | M14 | 2 345,50 |
| NAM-16 | M16 | 2 541,00 |

Konfirmat / Furniture screw



| INDEX | ROZMIAR SIZE [mm] | ILOŚĆ [szt.] QUANTITY [pcs] | CENA / PRICE 1000 szt./pcs [PLN] |
|------------------|----------------------|--------------------------------|--|
| KONF-5040 | 5,0 x 40 | 500 | 126,62 |
| KONF-6450 | 6,4 x 50 | 250 | 137,70 |
| KONF-7050 | 7,0 x 50 | 250 | 176,92 |
| KONF-7070 | 7,0 x 70 | 200 | 260,00 |

Wiertło do konfirmatów / Confirmat drill



| INDEX | ROZMIAR SIZE [mm] | ILOŚĆ [szt.] QUANTITY [pcs] | CENA / PRICE 1000 szt./pcs [PLN] |
|------------------|----------------------|--------------------------------|--|
| WRKON-064 | 6,40 | 1 | 18,00 |
| WRKON-070 | 7,00 | 1 | 18,00 |

Kluczyk do konfirmatów / Key to furniture screw



| INDEX | CENA / PRICE 1000 szt./pcs [PLN] |
|---------------|--|
| KONFKL | 180,00 |

Koszulka kotka rozporowego

Plug for solid materials



| INDEX | ROZMIAR SIZE [mm] | ILOŚĆ [szt.] QUANTITY [pcs] | CENA / PRICE za 1 blister / per 1 blister pack [PLN] |
|-----------|----------------------|--------------------------------|---|
| B-K-05 | 5 x 25 | 45 | 2,24 |
| B-K-06 | 6 x 30 | 40 | 2,86 |
| B-K-08 | 8 x 40 | 22 | 2,57 |
| B-K-10 | 10 x 50 | 12 | 2,48 |
| B-K-12 | 12 x 60 | 10 | 2,86 |
| B-K-12/80 | 12 x 80 | 7 | 2,88 |
| B-K-14 | 14 x 70 | 4 | 2,57 |
| B-K-16 | 16 x 80 | 2 | 2,61 |
| B-K-20 | 20 x 95 | 2 | 3,23 |

Kotek rozporowy z wkrętem z łbem stożkowym z nacięciem krzyżowym typ POZIDRIVE

Plug with a cross-headed wood screw type POZIDRIVE

AT-15-9042/2012



| INDEX | ROZMIAR SIZE [mm] | | ILOŚĆ [szt.] QUANTITY [pcs] | CENA / PRICE za 1 blister / per 1 blister pack [PLN] |
|-----------|----------------------|-----------|--------------------------------|---|
| B-05+ | 5 x 25 | 3,5 x 30 | 20 | 2,82 |
| B-06+ | 6 x 30 | 3,5 x 30 | 15 | 2,74 |
| B-06+340 | 6 x 30 | 3,5 x 40 | 15 | 2,90 |
| B-06+350 | 6 x 30 | 3,5 x 50 | 15 | 3,05 |
| B-06+450 | 6 x 30 | 4,0 x 50 | 12 | 2,95 |
| B-08+ | 8 x 40 | 4,0 x 45 | 10 | 2,76 |
| B-08+450 | 8 x 40 | 4,0 x 50 | 10 | 2,82 |
| B-08+460 | 8 x 40 | 4,0 x 60 | 10 | 3,02 |
| B-08+550 | 8 x 40 | 5,0 x 50 | 8 | 3,06 |
| B-08+560 | 8 x 40 | 5,0 x 60 | 8 | 3,22 |
| B-08+580 | 8 x 40 | 5,0 x 80 | 8 | 3,75 |
| B-10+560 | 10 x 50 | 5,0 x 60 | 8 | 3,60 |
| B-10+580 | 10 x 50 | 5,0 x 80 | 8 | 3,97 |
| B-10+660 | 10 x 50 | 6,0 x 60 | 6 | 3,62 |
| B-10+680 | 10 x 50 | 6,0 x 80 | 4 | 3,30 |
| B-10+6100 | 10 x 50 | 6,0 x 100 | 3 | 3,08 |

Kotek rozporowy z wkrętem z łbem sześciokątnym DIN 571

Plug with a pan cap wood screw

AT-15-9042/2012



| INDEX | ROZMIAR SIZE [mm] | | ILOŚĆ [szt.] QUANTITY [pcs] | CENA / PRICE za 1 blister / per 1 blister pack [PLN] |
|----------|----------------------|----------|--------------------------------|---|
| B-08/550 | 8 x 40 | 5 x 50 | 8 | 2,81 |
| B-08/560 | 8 x 40 | 5 x 60 | 6 | 3,18 |
| B-08/580 | 8 x 40 | 5 x 80 | 4 | 2,70 |
| B-10/660 | 10 x 50 | 6 x 60 | 5 | 3,04 |
| B-10/680 | 10 x 50 | 6 x 80 | 4 | 2,98 |
| B-10/100 | 10 x 50 | 6 x 100 | 4 | 3,29 |
| B-10/120 | 10 x 50 | 6 x 120 | 3 | 3,06 |
| B-12/60 | 12 x 60 | 8 x 60 | 3 | 3,24 |
| B-12/80 | 12 x 60 | 8 x 80 | 3 | 3,65 |
| B-12/100 | 12 x 80 | 8 x 100 | 2 | 3,26 |
| B-12/120 | 12 x 80 | 8 x 120 | 2 | 3,51 |
| B-14/80 | 14 x 70 | 10 x 80 | 2 | 3,80 |
| B-14/100 | 14 x 70 | 10 x 100 | 1 | 2,86 |
| B-14/120 | 14 x 70 | 10 x 120 | 1 | 2,99 |

Kołek rozporowy z hakiem kątowym

Plug with hook

AT-15-9042/2012 

| INDEX | ROZMIAR SIZE [mm] | ILOŚĆ [szt.] QUANTITY [pcs] | CENA / PRICE za 1 blister / per 1 blister pack [PLN] |
|-------|----------------------|--------------------------------|---|
| B-06K | 6 x 30 | 4,0 | 2,49 |
| B-08K | 8 x 40 | 5,0 | 2,89 |
| B-10K | 10 x 50 | 6,0 | 2,89 |
| B-12K | 12 x 60 | 8,0 | 3,95 |
| B-14K | 14 x 70 | 10,0 | 4,54 |

Kołek rozporowy z hakiem kątowym

Plug with hook

AT-15-9042/2012 

| INDEX | ROZMIAR SIZE [mm] | ILOŚĆ [szt.] QUANTITY [pcs] | CENA / PRICE za 1 blister / per 1 blister pack [PLN] |
|-------|----------------------|--------------------------------|---|
| B-06S | 6 x 30 | 4,0 | 3,17 |
| B-08S | 8 x 40 | 5,0 | 3,18 |
| B-10S | 10 x 50 | 6,0 | 3,68 |
| B-12S | 12 x 60 | 8,0 | 3,63 |

Kołek rozporowy z hakiem huśtawkowym

Plug with hook

AT-15-9042/2012 

| INDEX | ROZMIAR SIZE [mm] | ILOŚĆ [szt.] QUANTITY [pcs] | CENA / PRICE za 1 blister / per 1 blister pack [PLN] |
|-------|----------------------|--------------------------------|---|
| B-12H | 12 x 60 | 8,0 | 4,89 |

Kołek uniwersalny z wkrętem z łbem stożkowym i nacięciem krzyżowym typu POZIDRIVE

Universal plug with screw



| INDEX | ROZMIAR SIZE [mm] | ILOŚĆ [szt.] QUANTITY [pcs] | CENA / PRICE za 1 blister / per 1 blister pack [PLN] |
|------------|----------------------|--------------------------------|---|
| B-KS-06040 | 6 x 40 | 4 x 40 | 2,73 |
| B-KS-06050 | 6 x 40 | 4 x 50 | 2,92 |
| B-KS-06060 | 6 x 40 | 4 x 60 | 3,11 |
| B-KS-08050 | 8 x 50 | 5 x 50 | 3,58 |
| B-KS-08060 | 8 x 50 | 5 x 60 | 3,74 |
| B-KS-08070 | 8 x 50 | 5 x 70 | 3,98 |
| B-KS-10060 | 10 x 60 | 6 x 60 | 4,25 |
| B-KS-10070 | 10 x 60 | 6 x 70 | 3,23 |
| B-KS-10080 | 10 x 60 | 6 x 80 | 3,72 |
| B-KS-10100 | 10 x 60 | 6 x 100 | 3,98 |

Kołek rozporowy uniwersalny z hakiem kątowym

Universal plug with hook



| INDEX | ROZMIAR SIZE [mm] | ILOŚĆ [szt.] QUANTITY [pcs] | CENA / PRICE za 1 blister / per 1 blister pack [PLN] |
|----------|----------------------|--------------------------------|---|
| B-KS-06K | 6 x 30 | 3,5 | 3,38 |
| B-KS-08K | 8 x 40 | 4,5 | 4,29 |

Kołek rozporowy uniwersalny z hakiem sufitowym

Universal plug with ceiling hook



| INDEX | ROZMIAR SIZE [mm] | ILOŚĆ [szt.] QUANTITY [pcs] | CENA / PRICE za 1 blister / per 1 blister pack [PLN] |
|----------|----------------------|--------------------------------|---|
| B-KS-06S | 6 x 30 | 3,5 | 3,50 |
| B-KS-08S | 8 x 40 | 4,5 | 5,76 |



Komplet do mocowania umywalki

Set for fixing washbasins

| INDEX | ROZMIAR SIZE [mm] | | ILOŚĆ [szt.] QUANTITY [pcs] | CENA / PRICE za 1 blister / per 1 blister pack [PLN] |
|-----------|----------------------|---------|--------------------------------|---|
| B-KPU-100 | 12 x 60 | 8 x 100 | 2 | 4,63 |
| B-KPU-120 | 12 x 60 | 8 x 120 | 2 | 5,03 |



Komplet do mocowania muszli klozetowych

Set for fixing toilet bowls

| INDEX | ROZMIAR SIZE [mm] | | ILOŚĆ [szt.] QUANTITY [pcs] | CENA / PRICE za 1 blister / per 1 blister pack [PLN] |
|-----------|----------------------|--------|--------------------------------|---|
| B-KPM-100 | 10 x 50 | 6 x 80 | 2 | 3,24 |



Kołek do wbijania z lejkiem

Hammer drive plug with nail

AT-15-8327/2010

| INDEX | ROZMIAR SIZE [mm] | ILOŚĆ [szt.] QUANTITY [pcs] | CENA / PRICE za 1 blister / per 1 blister pack [PLN] |
|-----------|----------------------|--------------------------------|---|
| B-06L-040 | 6 x 40 | 20 | 4,42 |
| B-06L-060 | 6 x 60 | 20 | 5,30 |
| B-06L-080 | 6 x 80 | 15 | 5,41 |
| B-08L-045 | 8 x 45 | 10 | 4,43 |
| B-08L-060 | 8 x 60 | 10 | 5,16 |
| B-08L-080 | 8 x 80 | 10 | 6,19 |
| B-08L-100 | 8 x 100 | 10 | 6,05 |
| B-08L-120 | 8 x 120 | 10 | 6,83 |
| B-10L-080 | 10 x 80 | 10 | 5,96 |
| B-10L-100 | 10 x 100 | 5 | 6,64 |
| B-10L-120 | 10 x 120 | 5 | 7,58 |



Kołek do wbijania z kołnierzem

Hammer drive plug with nail t-type

AT-15-8327/2010

| INDEX | ROZMIAR SIZE [mm] | ILOŚĆ [szt.] QUANTITY [pcs] | CENA / PRICE za 1 blister / per 1 blister pack [PLN] |
|-----------|----------------------|--------------------------------|---|
| B-06K-040 | 6 x 40 | 20 | 4,40 |
| B-06K-060 | 6 x 60 | 20 | 5,36 |
| B-06K-080 | 6 x 80 | 15 | 5,69 |



Kołek stalowy typ "Molly" do płyt gipsowo-kartonowych

Hollow wall anchor

| INDEX | ROZMIAR SIZE [mm] | GRUBOŚĆ PŁYTY PLATE THICKNESS [mm] | ILOŚĆ [szt.] QUANTITY [pcs] | CENA / PRICE za 1 blister / per 1 blister pack [PLN] |
|-----------|----------------------|---------------------------------------|--------------------------------|---|
| BSM04020 | M4 x 20 | 2 - 6 | 5 | 3,60 |
| BSM04032 | M4 x 32 | 3 - 9 | 5 | 3,60 |
| BSM04038 | M4 x 38 | 8 - 16 | 5 | 3,60 |
| BSM04046 | M4 x 46 | 3 - 20 | 5 | 3,88 |
| BSM04059 | M4 x 59 | 31 - 38 | 5 | 4,28 |
| BSM05037 | M5 x 37 | 6 - 13 | 5 | 4,39 |
| BSM05052 | M5 x 52 | 3 - 16 | 5 | 4,87 |
| BSM05065 | M5 x 65 | 16 - 32 | 5 | 5,21 |
| BSM06037 | M6 x 37 | 6 - 13 | 5 | 4,73 |
| BSM06052 | M6 x 52 | 3 - 16 | 5 | 5,55 |
| BSM06065 | M6 x 65 | 16 - 32 | 5 | 6,24 |
| BSM06080 | M6 x 80 | 32 - 45 | 5 | 7,10 |
| BSM04032K | hak kątowy | 3 - 9 | 5 | 3,77 |
| BSM04032S | hak sufitowy | 3 - 9 | 5 | 4,08 |





Kotek do zamocowań w płytach gipsowo-kartonowych "DRIVA"

Driva pin for plaster walls

| INDEX | ROZMIAR SIZE [mm] | ILOŚĆ [szt.] QUANTITY [pcs] | CENA / PRICE za 1 blister / per 1 blister pack [PLN] |
|------------|----------------------|--------------------------------|---|
| B-DRIVA-01 | 6 x 22 | 20 | 4,17 |
| B-DRIVA-02 | 6 x 30 | 10 | 5,25 |



Kotek do pustych przestrzeni

Toggle anchor for empty spaces

| INDEX | ROZMIAR SIZE [mm] | ILOŚĆ [szt.] QUANTITY [pcs] | CENA / PRICE za 1 blister / per 1 blister pack [PLN] |
|-------------------|----------------------|--------------------------------|---|
| B-10GL wkręt PZ-2 | 10 x 35 | 10 | 3,76 |
| B-10GK hak kątowy | 10 x 35 | 8 | 5,66 |
| B-10G koszulka | 10 x 35 | 10 | 2,82 |



Wkręt fosfatowany samowierzący do skręcania profili typu TEX

Drywall screw

PN-EN14566 + A1:2012

| INDEX | ROZMIAR SIZE [mm] | ILOŚĆ [szt.] QUANTITY [pcs] | CENA / PRICE za 1 blister / per 1 blister pack [PLN] |
|---------------|----------------------|--------------------------------|---|
| B-WS-3911 | 3,9 x 11 | 200 | 9,73 |
| B-WS-3595 | 3,5 x 9,5 | 200 | 9,63 |
| B-WS-3911bw | 3,9 x 11 | 200 | 7,09 |
| B-WS-3595oc | 3,5 x 9,5 | 200 | 8,12 |
| B-WS-3911oc | 3,9 x 11 | 200 | 10,22 |
| B-WS-3911pcoc | 3,9 x 11 | 200 | 9,26 |



Wkręt fosfatowany samowierzący z gwintem do blachy

Drywall screw

PN-EN14566 + A1:2012

| INDEX | ROZMIAR SIZE [mm] | ILOŚĆ [szt.] QUANTITY [pcs] | CENA / PRICE za 1 blister / per 1 blister pack [PLN] |
|-----------|----------------------|--------------------------------|---|
| B-WS-3525 | 3,5 x 25 | 200 | 12,38 |
| B-WS-3535 | 3,5 x 35 | 200 | 15,74 |
| B-WS-3545 | 3,5 x 45 | 100 | 8,76 |



Wkręt fosfatowany z gwintem do blachy do płyt G-K

Drywall screw

PN-EN14566 + A1:2012

| INDEX | ROZMIAR SIZE [mm] | ILOŚĆ [szt.] QUANTITY [pcs] | CENA / PRICE za 1 blister / per 1 blister pack [PLN] |
|-----------|----------------------|--------------------------------|---|
| B-FS-3525 | 3,5 x 25 | 200 | 6,67 |
| B-FS-3535 | 3,5 x 35 | 200 | 8,09 |
| B-FS-3545 | 3,5 x 45 | 100 | 5,45 |
| B-FS-3555 | 3,5 x 55 | 100 | 6,32 |
| B-FS-4270 | 4,2 x 70 | 50 | 5,49 |



Wkręt fosfatowany z gwintem do drewna do płyt G-K

Drywall screw

PN-EN14566 + A1:2012

| INDEX | ROZMIAR SIZE [mm] | ILOŚĆ [szt.] QUANTITY [pcs] | CENA / PRICE za 1 blister / per 1 blister pack [PLN] |
|------------|----------------------|--------------------------------|---|
| B-FT-3525 | 3,5 x 25 | 200 | 6,47 |
| B-FT-3535 | 3,5 x 35 | 200 | 7,84 |
| B-FT-3545 | 3,5 x 45 | 100 | 5,29 |
| B-FT-3555 | 3,5 x 55 | 100 | 6,14 |
| B-FT-4270 | 4,2 x 70 | 50 | 5,34 |
| B-FT-4890 | 4,8 x 90 | 25 | 4,57 |
| B-FT-48100 | 4,8 x 100 | 25 | 5,17 |
| B-FT-48110 | 4,8 x 110 | 25 | 5,63 |
| B-FT-48120 | 4,8 x 120 | 25 | 7,69 |



Wkręt do cienkich blach, tworzyw sztucznych i drewna z tępym podkładkowym

Wafer head phillips, sharp point screw hardened, zinc plated

ITB-KOT-2022/0761 WYD.1



| INDEX | ROZMIAR SIZE [mm] | ILOŚĆ [szt.] QUANTITY [pcs] | CENA / PRICE za 1 blister / per 1 blister pack [PLN] |
|-----------|----------------------|--------------------------------|---|
| B-WM-4213 | 4,2 x 13 | 100 | 6,79 |
| B-WM-4216 | 4,2 x 16 | 100 | 7,92 |
| B-WM-4219 | 4,2 x 19 | 100 | 9,85 |
| B-WM-4225 | 4,2 x 25 | 50 | 6,30 |
| B-WM-4230 | 4,2 x 30 | 50 | 5,80 |
| B-WM-4238 | 4,2 x 38 | 40 | 5,80 |
| B-WM-4250 | 4,2 x 50 | 40 | 6,12 |
| B-WM-4265 | 4,2 x 65 | 30 | 5,80 |



Wkręt do cienkich blach, tworzyw sztucznych i drewna z tępym podkładkowym, fosfatowany

Wafer head phillips, sharp point screw hardened, phosphated

ITB-KOT-2022/0761 WYD.1



| INDEX | ROZMIAR SIZE [mm] | ILOŚĆ [szt.] QUANTITY [pcs] | CENA / PRICE za 1 blister / per 1 blister pack [PLN] |
|------------|----------------------|--------------------------------|---|
| B-WMF-4213 | 4,2 x 13 | 100 | 5,93 |
| B-WMF-4216 | 4,2 x 16 | 100 | 8,48 |
| B-WMF-4219 | 4,2 x 19 | 100 | 9,54 |
| B-WMF-4225 | 4,2 x 25 | 50 | 5,93 |
| B-WMF-4230 | 4,2 x 30 | 50 | 6,46 |
| B-WMF-4238 | 4,2 x 38 | 40 | 6,23 |
| B-WMF-4250 | 4,2 x 50 | 40 | 6,34 |
| B-WMF-4265 | 4,2 x 65 | 30 | 6,26 |



Wkręt montażowy samowiertny, przewodność max. 2,25 mm

Wafer head phillips, self-drilling screw hardened, zinc plated

ITB-KOT-2022/0761 WYD.1



| INDEX | ROZMIAR SIZE [mm] | ILOŚĆ [szt.] QUANTITY [pcs] | CENA / PRICE za 1 blister / per 1 blister pack [PLN] |
|------------|----------------------|--------------------------------|---|
| B-WMS-4213 | 4,2 x 13 | 100 | 8,72 |
| B-WMS-4216 | 4,2 x 16 | 100 | 9,58 |
| B-WMS-4219 | 4,2 x 19 | 100 | 10,04 |
| B-WMS-4225 | 4,2 x 25 | 50 | 6,90 |
| B-WMS-4232 | 4,2 x 32 | 50 | 7,68 |
| B-WMS-4240 | 4,2 x 40 | 40 | 7,51 |
| B-WMS-4250 | 4,2 x 50 | 40 | 7,98 |
| B-WMS-4265 | 4,2 x 65 | 30 | 7,45 |



Wkręt montażowy samowiertny uniwersalny fosfatowany, przewierc. max. 2,25 mm

Wafer head phillips, self-drilling screw hardened, phosphated

ITB-KOT-2022/0761 WYD.1



| INDEX | ROZMIAR SIZE [mm] | ILOŚĆ [szt.] QUANTITY [pcs] | CENA / PRICE za 1 blister / per 1 blister pack [PLN] |
|-------------|----------------------|--------------------------------|---|
| B-WMSF-4213 | 4,2 x 13 | 100 | 8,64 |
| B-WMSF-4216 | 4,2 x 16 | 100 | 8,42 |
| B-WMSF-4219 | 4,2 x 19 | 100 | 9,10 |
| B-WMSF-4225 | 4,2 x 25 | 50 | 6,53 |
| B-WMSF-4232 | 4,2 x 32 | 50 | 7,45 |
| B-WMSF-4240 | 4,2 x 40 | 40 | 7,51 |
| B-WMSF-4250 | 4,2 x 50 | 40 | 7,98 |
| B-WMSF-4265 | 4,2 x 65 | 30 | 7,94 |

Wkręt farmerski ETANCO do mocowania blach do konstrukcji drewnianych z aluminiową podkładką EPDM

Self drilling screw with EPDM washer



| INDEX | ROZMIAR SIZE [mm] | KOŁOŁR COLOR | ILOŚĆ [szt.] QUANTITY [pcs] | CENA / PRICE za 1 blister / per 1 blister pack [PLN] |
|--------------|----------------------|----------------------|--------------------------------|---|
| B-OD-20 oc | 4,8 x 20 | ocynk / zinc | 50 | 16,46 |
| B-OD-20 3009 | 4,8 x 20 | czerwony / red | 50 | 16,46 |
| B-OD-20 8004 | 4,8 x 20 | ceglasty / brick red | 50 | 16,46 |
| B-OD-20 8017 | 4,8 x 20 | brązowy / brown | 50 | 16,46 |
| B-OD-35 oc | 4,8 x 35 | ocynk / zinc | 50 | 16,46 |
| B-OD-35 3009 | 4,8 x 35 | czerwony / red | 50 | 17,10 |
| B-OD-35 8004 | 4,8 x 35 | ceglasty / brick red | 50 | 17,10 |
| B-OD-35 8017 | 4,8 x 35 | brązowy / brown | 50 | 17,10 |
| B-OD-60 oc | 4,8 x 60 | ocynk / zinc | 25 | 15,78 |
| B-OD-60 3009 | 4,8 x 60 | czerwony / red | 25 | 16,50 |
| B-OD-60 8004 | 4,8 x 60 | ceglasty / brick red | 25 | 16,50 |
| B-OD-60 8017 | 4,8 x 60 | brązowy / brown | 25 | 16,50 |

Wkręt samowiertny do mocowania blach do konstrukcji stalowych bez podkładki

Self drilling screw

ETA-17/0781



| INDEX | ROZMIAR SIZE [mm] | MAKSYMALNA PRZEWIERCALNOŚĆ DRILLING CAPACITY [mm] | ILOŚĆ [szt.] QUANTITY [pcs] | CENA / PRICE za 1 blister / per 1 blister pack [PLN] |
|-----------|----------------------|---|--------------------------------|---|
| B-OC-4813 | 4,8 x 13 | 3,0 | 50 | 5,85 |
| B-OC-4816 | 4,8 x 16 | 3,0 | 50 | 7,24 |
| B-OC-4819 | 4,8 x 19 | 3,0 | 50 | 7,85 |
| B-OC-4822 | 4,8 x 22 | 3,0 | 50 | 8,15 |
| B-OC-4825 | 4,8 x 25 | 3,0 | 50 | 8,59 |
| B-OC-4832 | 4,8 x 32 | 3,0 | 45 | 8,02 |
| B-OC-4835 | 4,8 x 35 | 3,0 | 45 | 8,24 |
| B-OC-4838 | 4,8 x 38 | 3,0 | 40 | 6,84 |
| B-OC-5519 | 5,5 x 19 | 5,0 | 40 | 7,18 |
| B-OC-5525 | 5,5 x 25 | 5,0 | 30 | 6,49 |
| B-OC-5575 | 5,5 x 75 | 5,0 | 20 | 8,42 |
| B-OC-6332 | 6,3 x 32 | 6,0 | 25 | 8,52 |
| B-OC-6363 | 6,3 x 63 | 6,0 | 15 | 8,50 |

Wkręt samowiertny do mocowania blach do konstrukcji stalowych z podkładką EPDM

Self drilling screw with EPDM washer

ETA-17/0781



| INDEX | ROZMIAR SIZE [mm] | MAKSYMALNA PRZEWIERCALNOŚĆ DRILLING CAPACITY [mm] | ILOŚĆ [szt.] QUANTITY [pcs] | CENA / PRICE za 1 blister / per 1 blister pack [PLN] |
|------------|----------------------|---|--------------------------------|---|
| B-OCG-4816 | 4,8 x 16 | 3,0 | 60 | 10,75 |
| B-OCG-4819 | 4,8 x 19 | 3,0 | 60 | 11,48 |
| B-OCG-4822 | 4,8 x 22 | 3,0 | 60 | 11,85 |
| B-OCG-4825 | 4,8 x 25 | 3,0 | 60 | 12,38 |
| B-OCG-4832 | 4,8 x 32 | 3,0 | 50 | 10,64 |
| B-OCG-4835 | 4,8 x 35 | 3,0 | 50 | 10,89 |
| B-OCG-4845 | 4,8 x 45 | 3,0 | 50 | 12,33 |
| B-OCG-4855 | 4,8 x 55 | 3,0 | 50 | 13,96 |
| B-OCG-5519 | 5,5 x 19 | 5,0 | 60 | 13,49 |
| B-OCG-5525 | 5,5 x 25 | 5,0 | 60 | 14,86 |
| B-OCG-5532 | 5,5 x 32 | 5,0 | 50 | 13,08 |
| B-OCG-5538 | 5,5 x 38 | 5,0 | 50 | 16,03 |
| B-OCG-5550 | 5,5 x 50 | 5,0 | 40 | 12,25 |

Wkręt hartowany do drewna, płyt wiórowych i PCV
Self-drilling roofing screw with EPDM washer

PN-EN-14592+A1:2022



| INDEX | ROZMIAR SIZE [mm] | ILOŚĆ [szt.] QUANTITY [pcs] | CENA / PRICE za 1 blister / per 1 blister pack [PLN] |
|-----------|----------------------|--------------------------------|---|
| B-UC-2512 | 2,5 x 12 | 100 | 3,70 |
| B-UC-2516 | 2,5 x 16 | 100 | 3,70 |
| B-UC-2520 | 2,5 x 20 | 100 | 3,70 |
| B-UC-3012 | 3,0 x 12 | 100 | 3,87 |
| B-UC-3016 | 3,0 x 16 | 100 | 4,49 |
| B-UC-3020 | 3,0 x 20 | 100 | 4,89 |
| B-UC-3025 | 3,0 x 25 | 100 | 5,19 |
| B-UC-3030 | 3,0 x 30 | 90 | 5,71 |
| B-UC-3035 | 3,0 x 35 | 80 | 5,68 |
| B-UC-3040 | 3,0 x 40 | 50 | 3,45 |
| B-UC-3512 | 3,5 x 12 | 100 | 4,39 |
| B-UC-3516 | 3,5 x 16 | 90 | 4,47 |
| B-UC-3520 | 3,5 x 20 | 80 | 4,69 |
| B-UC-3525 | 3,5 x 25 | 80 | 4,26 |
| B-UC-3530 | 3,5 x 30 | 70 | 5,22 |
| B-UC-3535 | 3,5 x 35 | 60 | 5,11 |
| B-UC-3540 | 3,5 x 40 | 50 | 4,70 |
| B-UC-3545 | 3,5 x 45 | 50 | 4,81 |
| B-UC-3550 | 3,5 x 50 | 50 | 5,18 |
| B-UC-4012 | 4,0 x 12 | 90 | 3,94 |
| B-UC-4016 | 4,0 x 16 | 80 | 4,52 |
| B-UC-4020 | 4,0 x 20 | 70 | 4,70 |
| B-UC-4025 | 4,0 x 25 | 60 | 4,54 |
| B-UC-4030 | 4,0 x 30 | 50 | 4,50 |
| B-UC-4035 | 4,0 x 35 | 50 | 4,84 |
| B-UC-4040 | 4,0 x 40 | 50 | 5,11 |
| B-UC-4045 | 4,0 x 45 | 50 | 5,74 |
| B-UC-4050 | 4,0 x 50 | 35 | 4,69 |
| B-UC-4060 | 4,0 x 60 | 30 | 4,82 |
| B-UC-4070 | 4,0 x 70 | 25 | 4,91 |
| B-UC-4525 | 4,5 x 25 | 50 | 4,71 |
| B-UC-4530 | 4,5 x 30 | 40 | 4,47 |
| B-UC-4535 | 4,5 x 35 | 40 | 4,92 |
| B-UC-4540 | 4,5 x 40 | 40 | 5,30 |
| B-UC-4545 | 4,5 x 45 | 40 | 5,79 |
| B-UC-4550 | 4,5 x 50 | 30 | 4,59 |
| B-UC-4560 | 4,5 x 60 | 20 | 4,31 |
| B-UC-4570 | 4,5 x 70 | 20 | 4,83 |
| B-UC-4580 | 4,5 x 80 | 15 | 4,40 |
| B-UC-5020 | 5,0 x 20 | 50 | 3,93 |
| B-UC-5025 | 5,0 x 25 | 40 | 3,85 |
| B-UC-5030 | 5,0 x 30 | 40 | 4,30 |
| B-UC-5035 | 5,0 x 35 | 35 | 3,92 |
| B-UC-5040 | 5,0 x 40 | 30 | 5,40 |
| B-UC-5045 | 5,0 x 45 | 30 | 5,51 |
| B-UC-5050 | 5,0 x 50 | 25 | 5,36 |
| B-UC-5060 | 5,0 x 60 | 20 | 5,00 |
| B-UC-5070 | 5,0 x 70 | 20 | 5,67 |
| B-UC-5080 | 5,0 x 80 | 15 | 4,91 |
| B-UC-5090 | 5,0 x 90 | 15 | 5,33 |
| B-UC-5100 | 5,0 x 100 | 10 | 4,36 |
| B-UC-5110 | 5,0 x 110 | 10 | 4,62 |
| B-UC-5120 | 5,0 x 120 | 8 | 4,23 |

Wkręt hartowany do drewna, płyt wiórowych i PCV

Self-drilling roofing screw with EPDM washer



| INDEX | ROZMIAR SIZE [mm] | ILOŚĆ [szt.] QUANTITY [pcs] | CENA / PRICE za 1 blister / per 1 blister pack [PLN] |
|-----------|----------------------|--------------------------------|---|
| B-UC-6030 | 6,0 x 30 | 25 | 4,93 |
| B-UC-6040 | 6,0 x 40 | 20 | 4,52 |
| B-UC-6045 | 6,0 x 45 | 20 | 4,87 |
| B-UC-6050 | 6,0 x 50 | 15 | 4,29 |
| B-UC-6060 | 6,0 x 60 | 15 | 5,40 |
| B-UC-6070 | 6,0 x 70 | 10 | 3,81 |
| B-UC-6080 | 6,0 x 80 | 10 | 5,04 |
| B-UC-6090 | 6,0 x 90 | 10 | 4,42 |
| B-UC-6100 | 6,0 x 100 | 8 | 4,87 |
| B-UC-6110 | 6,0 x 110 | 8 | 5,47 |
| B-UC-6120 | 6,0 x 120 | 5 | 4,21 |

Tuleja stalowa

Drop in anchor



| INDEX | ROZMIAR SIZE [mm] | ILOŚĆ [szt.] QUANTITY [pcs] | CENA / PRICE za 1 blister / per 1 blister pack [PLN] |
|---------|----------------------|--------------------------------|---|
| B-TS-06 | 8 x 25 | 10 | 4,80 |
| B-TS-08 | 10 x 30 | 8 | 4,80 |
| B-TS-10 | 12 x 40 | 6 | 4,80 |
| B-TS-12 | 15 x 50 | 4 | 6,17 |
| B-TS-16 | 20 x 65 | 2 | 6,44 |

Tuleja mosiężna

Brass anchor



| INDEX | ROZMIAR SIZE [mm] | ILOŚĆ [szt.] QUANTITY [pcs] | CENA / PRICE za 1 blister / per 1 blister pack [PLN] |
|---------|----------------------|--------------------------------|---|
| B-TM-05 | 7 x 20 | 8 | 4,80 |
| B-TM-06 | 8 x 25 | 6 | 4,80 |
| B-TM-08 | 10 x 30 | 6 | 6,81 |
| B-TM-10 | 12 x 40 | 3 | 5,54 |
| B-TM-12 | 15 x 40 | 2 | 4,80 |
| B-TM-16 | 20 x 44 | 1 | 7,78 |

Wkręt dwugwintowy

Hanger bolt



| INDEX | ROZMIAR SIZE [mm] | ILOŚĆ [szt.] QUANTITY [pcs] | CENA / PRICE za 1 blister / per 1 blister pack [PLN] |
|------------|----------------------|--------------------------------|---|
| B-WD-08050 | 8 x 50 | 5 | 3,50 |
| B-WD-08060 | 8 x 60 | 5 | 3,50 |
| B-WD-08070 | 8 x 70 | 4 | 3,50 |
| B-WD-08080 | 8 x 80 | 4 | 3,50 |
| B-WD-08100 | 8 x 100 | 4 | 3,50 |
| B-WD-08120 | 8 x 120 | 4 | 3,90 |
| B-WD-10060 | 10 x 60 | 5 | 3,90 |
| B-WD-10080 | 10 x 80 | 4 | 3,90 |
| B-WD-10100 | 10 x 100 | 4 | 4,53 |
| B-WD-10120 | 10 x 120 | 4 | 5,24 |

Nit zrywalny Al/Fe

Open type blind rivet with dome head



| INDEX | ROZMIAR SIZE [mm] | ILOŚĆ [szt.] QUANTITY [pcs] | CENA / PRICE za 1 blister / per 1 blister pack [PLN] |
|-----------|----------------------|--------------------------------|---|
| B-NIT 306 | 3 x 6 | 30 | 2,70 |
| B-NIT 308 | 3 x 8 | 30 | 2,70 |
| B-NIT 310 | 3 x 10 | 25 | 2,70 |
| B-NIT 312 | 3 x 12 | 25 | 2,70 |
| B-NIT 406 | 4 x 6 | 25 | 2,70 |
| B-NIT-408 | 4 x 8 | 20 | 2,70 |
| B-NIT-410 | 4 x 10 | 20 | 2,70 |
| B-NIT-412 | 4 x 12 | 20 | 2,70 |
| B-NIT-414 | 4 x 14 | 15 | 2,70 |
| B-NIT-416 | 4 x 16 | 15 | 2,70 |
| B-NIT-418 | 4 x 18 | 15 | 2,70 |
| B-NIT-420 | 4 x 20 | 12 | 2,70 |
| B-NIT-506 | 5 x 6 | 12 | 2,70 |
| B-NIT-508 | 5 x 8 | 12 | 2,70 |
| B-NIT-510 | 5 x 10 | 12 | 2,70 |
| B-NIT-512 | 5 x 12 | 10 | 2,70 |
| B-NIT-514 | 5 x 14 | 10 | 2,70 |
| B-NIT-516 | 5 x 16 | 10 | 2,70 |
| B-NIT-518 | 5 x 18 | 10 | 2,70 |
| B-NIT-520 | 5 x 20 | 10 | 2,70 |
| B-NIT-522 | 5 x 22 | 8 | 2,70 |
| B-NIT-524 | 5 x 24 | 8 | 2,70 |
| B-NIT-526 | 5 x 26 | 8 | 2,70 |
| B-NIT-610 | 6 x 10 | 8 | 2,70 |
| B-NIT-612 | 6 x 12 | 8 | 2,70 |
| B-NIT-614 | 6 x 14 | 8 | 2,70 |
| B-NIT-616 | 6 x 16 | 6 | 2,70 |
| B-NIT-618 | 6 x 18 | 6 | 2,70 |
| B-NIT-620 | 6 x 20 | 6 | 2,70 |

Zacisk do lin, ocynkowany

Wire rope clip

DIN 741



| INDEX | ŚREDNICA DIAMETER [mm] | ILOŚĆ [szt.] QUANTITY [pcs] | CENA / PRICE za 1 blister / per 1 blister pack [PLN] |
|-------------|---------------------------|--------------------------------|---|
| B-ZAC-03 | 3,0 | 5 | 3,00 |
| B-ZAC-05 | 5,0 | 4 | 3,00 |
| B-ZAC-06 | 6,0 | 3 | 3,00 |
| B-ZAC-08 | 8,0 | 2 | 3,00 |
| B-ZAC-10 | 10,0 | 1 | 3,00 |
| B-ZAC-12/13 | 12,0/13,0 | 1 | 3,50 |

Podkładka sprężynowa, ocynkowana

Spring washer

PN-82008
DIN 127B



| INDEX | ROZMIAR SIZE [mm] | ŚREDNICA OTWORU HOLE DIAMETE [mm] | ILOŚĆ [szt.] QUANTITY [pcs] | CENA / PRICE za 1 blister / per 1 blister pack [PLN] |
|-----------|----------------------|--------------------------------------|--------------------------------|---|
| B-PODS-03 | M3 | 3,1 | 100 | 1,95 |
| B-PODS-04 | M4 | 4,1 | 80 | 1,95 |
| B-PODS-05 | M5 | 5,1 | 50 | 1,95 |
| B-PODS-06 | M6 | 6,1 | 25 | 2,35 |
| B-PODS-08 | M8 | 8,2 | 15 | 2,35 |
| B-PODS-10 | M10 | 10,2 | 10 | 2,35 |
| B-PODS-12 | M12 | 12,2 | 10 | 2,76 |
| B-PODS-14 | M14 | 14,2 | 10 | 3,35 |
| B-PODS-16 | M16 | 16,3 | 10 | 4,42 |
| B-PODS-20 | M20 | 20,5 | 5 | 2,58 |

Podkładka okrągła zgrubna powiększona, ocynkowana

Round washer

PN-82030
DIN 9021



| INDEX | ROZMIAR SIZE [mm] | ŚREDNICA OTWORU HOLE DIAMETE [mm] | ILOŚĆ [szt.] QUANTITY [pcs] | CENA / PRICE za 1 blister / per 1 blister pack [PLN] |
|------------|----------------------|--------------------------------------|--------------------------------|---|
| B-POP-3004 | M4 | 4,2 | 60 | 2,89 |
| B-POP-3005 | M5 | 5,5 | 40 | 3,37 |
| B-POP-3006 | M6 | 6,5 | 20 | 3,19 |
| B-POP-3008 | M8 | 8,5 | 10 | 3,30 |
| B-POP-3010 | M10 | 10,5 | 6 | 3,59 |
| B-POP-3012 | M12 | 13,0 | 4 | 3,90 |
| B-POP-3014 | M14 | 15,0 | 3 | 4,11 |
| B-POP-3016 | M16 | 17,0 | 2 | 3,73 |
| B-POP-3020 | M20 | 21,0 | 1 | 3,59 |

Podkładka okrągła poszerzona, ocynkowana

Round washer

PN-82019
DIN 440R



| INDEX | ROZMIAR SIZE [mm] | ŚREDNICA OTWORU HOLE DIAMETE [mm] | ILOŚĆ [szt.] QUANTITY [pcs] | CENA / PRICE za 1 blister / per 1 blister pack [PLN] |
|------------|----------------------|--------------------------------------|--------------------------------|---|
| B-POP-1905 | M5 | 5,5 | 20 | 3,78 |
| B-POP-1906 | M6 | 6,6 | 10 | 3,06 |
| B-POP-1908 | M8 | 9,0 | 5 | 3,23 |
| B-POP-1910 | M10 | 11,0 | 5 | 4,11 |
| B-POP-1912 | M12 | 14,0 | 5 | 7,43 |
| B-POP-1914 | M14 | 16,0 | 4 | 8,13 |
| B-POP-1916 | M16 | 18,0 | 2 | 6,30 |

Podkładka okrągła zgrubna, ocynkowana

Round washer

PN-82005
DIN 125



| INDEX | ROZMIAR SIZE [mm] | ŚREDNICA OTWORU HOLE DIAMETE [mm] | ILOŚĆ [szt.] QUANTITY [pcs] | CENA / PRICE za 1 blister / per 1 blister pack [PLN] |
|----------|----------------------|--------------------------------------|--------------------------------|---|
| B-POD-03 | M3 | 3,2 | 160 | 2,04 |
| B-POD-04 | M4 | 4,3 | 120 | 2,73 |
| B-POD-05 | M5 | 5,3 | 80 | 2,27 |
| B-POD-06 | M6 | 6,4 | 40 | 2,76 |
| B-POD-08 | M8 | 8,4 | 20 | 2,62 |
| B-POD-10 | M10 | 10,5 | 10 | 2,60 |
| B-POD-12 | M12 | 13,0 | 10 | 3,38 |
| B-POD-14 | M14 | 15,0 | 8 | 3,57 |
| B-POD-16 | M16 | 17,0 | 5 | 3,14 |
| B-POD-20 | M20 | 21,0 | 3 | 2,90 |

Nakrętka sześciokątna, ocynkowana
Metric hexagon nut

PN-82144
DIN 934



| INDEX | ROZMIAR SIZE [mm] | ILOŚĆ [szt.] QUANTITY [pcs] | CENA / PRICE za 1 blister / per 1 blister pack [PLN] |
|----------|----------------------|--------------------------------|---|
| B-NAK-03 | M3 | 40 | 1,95 |
| B-NAK-04 | M4 | 35 | 2,22 |
| B-NAK-05 | M5 | 25 | 2,23 |
| B-NAK-06 | M6 | 20 | 2,46 |
| B-NAK-08 | M8 | 10 | 2,45 |
| B-NAK-10 | M10 | 5 | 2,49 |
| B-NAK-12 | M12 | 4 | 2,75 |
| B-NAK-14 | M14 | 3 | 2,94 |
| B-NAK-16 | M16 | 3 | 3,14 |
| B-NAK-20 | M20 | 2 | 3,82 |

Nakrętka samokontrująca z wkładką, ocynkowana
Plain nylon insert lock nut

PN-82175
DIN 985



| INDEX | ROZMIAR SIZE [mm] | ILOŚĆ [szt.] QUANTITY [pcs] | CENA / PRICE za 1 blister / per 1 blister pack [PLN] |
|------------|----------------------|--------------------------------|---|
| B-NAKWK-04 | M4 | 10 | 1,95 |
| B-NAKWK-05 | M5 | 10 | 1,95 |
| B-NAKWK-06 | M6 | 10 | 2,05 |
| B-NAKWK-08 | M8 | 6 | 2,18 |
| B-NAKWK-10 | M10 | 4 | 2,51 |
| B-NAKWK-12 | M12 | 2 | 2,20 |
| B-NAKWK-14 | M14 | 2 | 2,65 |
| B-NAKWK-16 | M16 | 2 | 3,03 |
| B-NAKWK-20 | M20 | 2 | 4,55 |

Nakrętka kołpakowa, ocynkowana
Hexagonal domed cap nut

PN-82181
DIN 1587



| INDEX | ROZMIAR SIZE [mm] | ILOŚĆ [szt.] QUANTITY [pcs] | CENA / PRICE za 1 blister / per 1 blister pack [PLN] |
|-----------|----------------------|--------------------------------|---|
| B-NAKK-05 | M5 | 6 | 1,95 |
| B-NAKK-06 | M6 | 6 | 2,08 |
| B-NAKK-08 | M8 | 4 | 2,32 |
| B-NAKK-10 | M10 | 2 | 2,22 |
| B-NAKK-12 | M12 | 2 | 2,71 |
| B-NAKK-14 | M14 | 2 | 3,19 |
| B-NAKK-16 | M16 | 2 | 3,97 |
| B-NAKK-20 | M20 | 2 | 7,05 |

Nakrętka motylkowa, ocynkowana
Wing nut

DIN 315



| INDEX | ROZMIAR SIZE [mm] | ILOŚĆ [szt.] QUANTITY [pcs] | CENA / PRICE za 1 blister / per 1 blister pack [PLN] |
|----------|----------------------|--------------------------------|---|
| B-NAM-04 | M4 | 8 | 2,07 |
| B-NAM-05 | M5 | 6 | 2,13 |
| B-NAM-06 | M6 | 4 | 2,05 |
| B-NAM-08 | M8 | 3 | 1,95 |
| B-NAM-10 | M10 | 2 | 2,15 |
| B-NAM-12 | M12 | 2 | 2,47 |

Nakrętka złączna
Coupling nut

DIN 6334



| INDEX | ROZMIAR SIZE [mm] | ILOŚĆ [szt.] QUANTITY [pcs] | CENA / PRICE za 1 blister / per 1 blister pack [PLN] |
|---------|----------------------|--------------------------------|---|
| B-NZ-06 | M6 x 18 | 10 | 5,00 |
| B-NZ-08 | M8 x 24 | 8 | 5,46 |
| B-NZ-10 | M10 x 30 | 6 | 8,09 |
| B-NZ-12 | M12 x 36 | 4 | 7,72 |
| B-NZ-14 | M14 x 42 | 2 | 6,32 |
| B-NZ-16 | M16 x 48 | 2 | 7,84 |

Kotek uniwersalny DUOPOWER

Universal plug with a screw

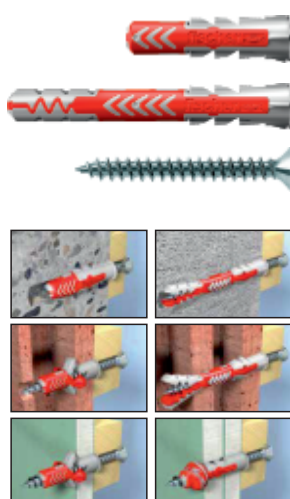

DUOPOWER BOX

| INDEX | ROZMIAR SIZE [mm] | | ILOŚĆ [szt.] QUANTITY [pcs] | | CENA / PRICE 1000 szt./pcs [PLN] |
|---------------------|--|-----------|--------------------------------|------|--|
| | | | | | |
| FIS-DUK05025 | 5 x 25 | - | 100 | 4000 | 218,68 |
| FIS-DUK06030 | 6 x 30 | - | 100 | 5000 | 333,93 |
| FIS-DUK06050 | 6 x 50 | - | 100 | 2500 | 639,49 |
| FIS-DUK08040 | 8 x 40 | - | 100 | 2500 | 479,91 |
| FIS-DUK08065 | 8 x 65 | - | 50 | 1200 | 744,10 |
| FIS-DUK10050 | 10 x 50 | - | 50 | 1200 | 929,09 |
| FIS-DUK10080 | 10 x 80 | - | 25 | 500 | 1422,59 |
| FIS-DUK12060 | 12 x 60 | - | 25 | 600 | 1369,99 |
| FIS-DUK14070 | 14 x 70 | - | 20 | 400 | 2544,34 |
| FIS-DUO05025s | 5 x 25 | 4.0 x 35 | 50 | 2500 | 1017,74 |
| FIS-DUO06030s | 6 x 30 | 4.5 x 40 | 50 | 2500 | 1057,34 |
| FIS-DUO06050s | 6 x 50 | 4.5 x 70 | 50 | 1200 | 2022,48 |
| FIS-DUO08040s | 8 x 40 | 5.0 x 60 | 50 | 1200 | 1539,62 |
| FIS-DUO08065s | 8 x 65 | 5.0 x 80 | 25 | 600 | 2387,74 |
| FIS-DUO10050s | 10 x 50 | 7.0 x 70 | 25 | 250 | 3491,90 |
| FIS-DUO10080s | 10 x 80 | 7.0 x 107 | 10 | 240 | 5088,71 |
| FIS-DUO12060s | 12 x 60 | 8.0 x 80 | 10 | 250 | 4723,46 |
| FIS-DUO14070s | 14 x 70 | 10.0 x 95 | 8 | 80 | 8754,83 |
| DUOPOWER BOX | DUOPOWER: 5 x 25 - 15 szt., 6 x 30 - 70 szt., 8x40 - 40 szt., 10x50 - 15 szt. WKREŃ: PZ 4,0x35 - 15 szt., SZ 4,5x40 ZPF - 70 szt., SZ 5,0x60 ZPF - 40 szt., HEX 7x69 - 15 szt. | | | | 140,00 (opak./box) |

Kotek DUOTEC do płyt GK

Nylon toggle fischer DUOTEC



| INDEX | ROZMIAR SIZE [mm] | | ILOŚĆ [szt.] QUANTITY [pcs] | CENA / PRICE 1000 szt./pcs [PLN] |
|---------------|----------------------|-----------|--------------------------------|--|
| | | | | |
| FIS-DUOT10 | 10.0 | 4.5 - 5.0 | 50 | 4212,46 |
| FIS-DUOT10S | 10.0 | 5.0 | 25 | 4459,95 |
| FIS-DUOT10SPH | 10.0 | 5.0 | 25 | 4956,06 |

MONTAŻ W PŁYTACH Z PUSTYMI PRZESTRZENIAM:

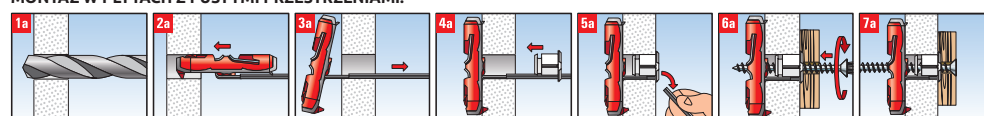

MONTAŻ W PEŁNYM MATERIALE:

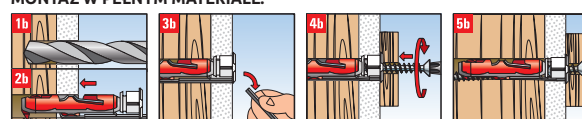

Kotek uniwersalny Fischer SX

Universal plug with screw



| INDEX | ROZMIAR SIZE [mm] | ILOŚĆ [szt.] QUANTITY [pcs] | | CENA / PRICE 1000 szt./pcs [PLN] |
|---------------|----------------------|--------------------------------|--|--|
| | | | | |
| FIS-SX 4x20 | 2.0-3.0 | 200 | | 194,78 |
| FIS-SX 5x25 | 3.0-4.0 | 100 | | 221,74 |
| FIS-SX 6x30 | 4.0-5.0 | 100 | | 324,35 |
| FIS-SX 8x40 | 4.5-6.0 | 100 | | 460,66 |
| FIS-SX 10x50 | 6.0-8.0 | 50 | | 898,08 |
| FIS-SX 12x60 | 8.0-10.0 | 25 | | 1325,21 |
| FIS-SX 14x70 | 10.0-12.0 | 20 | | 2518,09 |
| FIS-SX 16x80 | 12(1/2") | 10 | | 3578,97 |
| FIS-SX 6x50 | 4.0-5.0 | 100 | | 631,35 |
| FIS-SX 8x65 | 4.5-6.0 | 50 | | 775,75 |
| FIS-SX 10x80 | 6.0-8.0 | 25 | | 1383,68 |
| FIS-SX-S 6x30 | 4.5 x 40 | 50 | | 1011,14 |
| FIS-SX-S 8x40 | 5.0 x 60 | 50 | | 1471,07 |

Kotek uniwersalny Fischer UX

Universal plug with screw



| INDEX | ROZMIAR SIZE [mm] | | ILOŚĆ [szt.] QUANTITY [pcs] | | CENA / PRICE 1000 szt./pcs [PLN] |
|--------------------|----------------------|----------|--------------------------------|------|--|
| | | | | | |
| FIS-UX5 | 5 x 30 | - | 100 | 5000 | 415,09 |
| FIS-UX6 | 6 x 35 | - | 100 | 5000 | 498,74 |
| FIS-UX8 | 8 x 50 | - | 100 | 2000 | 680,72 |
| FIS-UX10 | 10 x 60 | - | 50 | 1000 | 1 251,72 |
| FIS-UX12 | 12 x 70 | - | 25 | 600 | 2 002,05 |
| FIS-UX14 | 14 x 75 | - | 20 | 400 | 3 214,54 |
| FIS-UX 6x35R S/20 | 6 x 35 | 4.5 x 60 | 25 | 625 | 1 955,55 |
| FIS-UX 6x50R S/20 | 6 x 50 | 4.5 x 70 | 25 | 625 | 2 494,90 |
| FIS-UX 8x50R S/15 | 8 x 50 | 5.0 x 70 | 25 | 600 | 2 635,93 |
| FIS-UX 8x50R S/25 | 8 x 50 | 5.0 x 80 | 25 | 600 | 3 211,17 |
| FIS-UX 10x60R S/20 | 10 x 60 | 6.0 x 85 | 10 | 250 | 6 149,88 |
| FIS-UX 6x35 WH | 6 x 35 | 4.5 x 51 | 25 | 625 | 9 769,14 |
| FIS-UX 8x50 WH | 8 x 50 | 5.5 x 70 | 25 | 625 | 9 824,94 |
| FIS-UX 6x35 RH | 6 x 35 | 4.5 x 67 | 25 | 625 | 9 684,39 |
| FIS-UX 8x50 RH | 8 x 50 | 5.5 x 87 | 25 | 500 | 10 026,44 |

Kotek uniwersalny FU

Frame fixing with screw

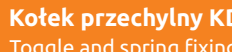

| INDEX | ROZMIAR SIZE [mm] | | ILOŚĆ [szt.] QUANTITY [pcs] | | CENA / PRICE 1000 szt./pcs [PLN] |
|-------------------|----------------------|----------|--------------------------------|------|--|
| | | | | | |
| FIS-FU 6x35 | 6 x 35 | - | 50 | 2500 | 880,00 |
| FIS-FU 6x45 | 6 x 45 | - | 50 | 2500 | 955,24 |
| FIS-FU 8x40 | 8 x 40 | - | 50 | 2500 | 1 172,40 |
| FIS-FU 8x50 | 8 x 50 | - | 50 | 1250 | 1 210,00 |
| FIS-FU 10x60 | 10 x 60 | - | 25 | 625 | 2 342,60 |
| FIS-FU 6x35 S/20 | 6 x 35 | 3.5 x 55 | 25 | 1250 | 2 764,87 |
| FIS-FU 8x50 S/25 | 8 x 50 | 4.5 x 75 | 25 | 600 | 4 598,50 |
| FIS-FU 10x60 S/25 | 10 x 60 | 6.5 x 85 | 10 | 250 | 6 779,37 |
| FIS-FU 6x45 S/10 | 6 x 45 | 3.5 x 55 | 25 | 1250 | 2 561,37 |
| FIS-FU 6x35 S/10 | 6 x 35 | 3.5 x 45 | 25 | 1250 | 1 840,50 |
| FIS-FU 8x50 S/10 | 8 x 50 | 4.5 x 60 | 25 | 500 | 2 537,37 |
| FIS-FU 10x60 S/20 | 10 x 60 | 6.5 x 80 | 10 | 250 | 4 846,00 |

Kotek przechyłny KD

Toggle and spring fixing KD

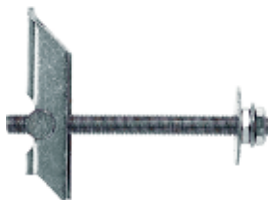

| INDEX | ROZMIAR SIZE [mm] | ILOŚĆ [szt.] QUANTITY [pcs] | | CENA / PRICE 1000 szt./pcs [PLN] |
|---------|----------------------|--------------------------------|--|--|
| | | | | |
| FIS-KD4 | M4 x 100 | 25 | | 7 040,37 |
| FIS-KD5 | M5 x 100 | 25 | | 8 049,77 |
| FIS-KD6 | M6 x 100 | 25 | | 8 051,98 |
| FIS-KD8 | M8 x 100 | 20 | | 10 558,35 |

Oznacznik montażowy do centrowania otworów stopni schodowych

Installation aid



| INDEX | ILOŚĆ [szt.] QUANTITY [pcs] | | CENA / PRICE 1000 szt./pcs [PLN] |
|----------|--------------------------------|-----|--|
| | | | |
| FIS-TBZ2 | 10 | 100 | 6 175,49 |

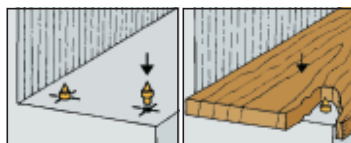

Mocowanie do schodów w konstrukcji stalowej

Plug for fixing stair treads



| INDEX | ŚR. OTWORU W STOPNICY Diameter of the hole in the tread [mm] | ROZMIAR SIZE [mm] | ILOŚĆ [szt.] QUANTITY [pcs] | | CENA / PRICE 1000 szt./pcs [PLN] |
|--------|--|----------------------|--------------------------------|-----|--|
| | | | | | |
| FIS-TB | 14 x 25 | 5 x 40 | 50 | 500 | 8 834,67 |

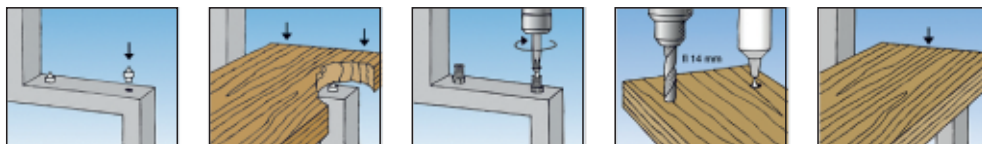

Mocowanie do schodów na podłożu z betonu

Plug for fixing stair treads



| INDEX | ŚR. OTWORU W STOPNICY Diameter of the hole in the tread [mm] | ŚR. OTWORU W BETONIE Diameter of the hole in concrete [mm] | ILOŚĆ [szt.] QUANTITY [pcs] | | CENA / PRICE 1000 szt./pcs [PLN] |
|---------|--|--|--------------------------------|-----|--|
| | | | | | |
| FIS-TBB | 14 x 25 | 8 x 55 | 50 | 250 | 8 695,50 |

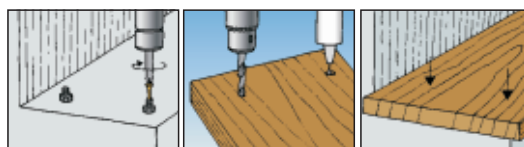

Odbijnik drzwiowy TS

Door bumper



| INDEX | ROZMIAR SIZE [mm] | KOLOR COLOR | ILOŚĆ [szt.] QUANTITY [pcs] | | CENA / PRICE 10 szt./pcs [PLN] |
|--------------|----------------------|------------------|--------------------------------|-----|--------------------------------------|
| | | | | | |
| FIS-TS 8 BG | 8 x 60 | beżowy / beige | 10 | 100 | 169,71 |
| FIS-TS 8 BR | 8 x 60 | brązowy / brown | 10 | 100 | 169,71 |
| FIS-TS 8 G | 8 x 60 | srebrny / silver | 10 | 100 | 169,71 |
| FIS-TS 8 S | 8 x 60 | czarny / black | 10 | 100 | 171,30 |
| FIS-ODTS 8 W | 8 x 60 | biały / white | 10 | 100 | 171,30 |

| | | | | | |
|---------|--------|--|---|---|--------|
| TS-SORT | 8 x 60 | zestaw 25 szt. (5 kolorów) set of 25 items (5 colors) | 1 | 4 | 490,82 |
|---------|--------|--|---|---|--------|

Kotek PD do płyt gipsowo-kartonowych, wiórowych, cementowo-piślniowych

Board fixing

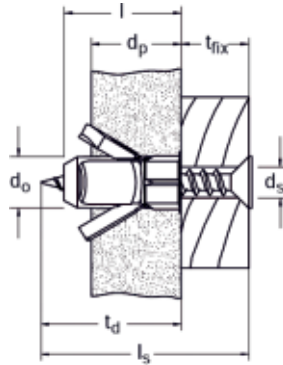

| INDEX | d _o [mm] | t _d [mm] | d _p [mm] | l [mm] | d _s x l _s [mm] | ILOŚĆ [szt.] QUANTITY [pcs] | | CENA / PRICE 1000 szt./pcs [PLN] |
|-----------------|------------------------|------------------------|------------------------|-----------|---|--------------------------------|------|--|
| | | | | | | | | |
| FIS-PD8 | 8 | 31 | 6 | 29 | 4 | 100 | 5000 | 1 156,83 |
| FIS-PD10 | 10 | 30 | 7 | 28 | 5 | 100 | 2500 | 1 524,03 |
| FIS-PD12 | 12 | 28 | 9 | 27 | 6 | 50 | 2500 | 1 833,44 |

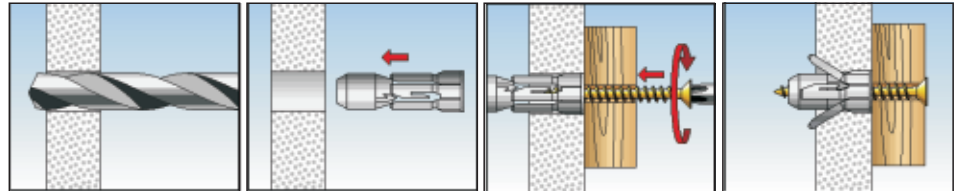

Kotek ramowy DuoXpand

Frame fixing DuoXpand

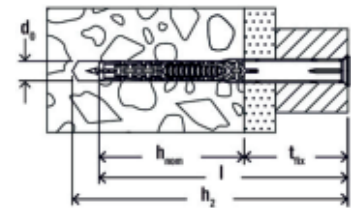

| INDEX | d _o [mm] | h ₂ [mm] | l [mm] | ILOŚĆ [szt.] QUANTITY [pcs] | | CENA / PRICE 1000 szt./pcs [PLN] |
|----------------------|------------------------|------------------------|-----------|--------------------------------|-----|--|
| | | | | | | |
| fis-dux08080F | 8 | 90 | 80 | 50 | 500 | 5 480,00 |
| fis-dux08080T | 8 | 90 | 80 | 50 | 500 | 5 237,00 |
| fis-dux08100F | 8 | 110 | 100 | 50 | 500 | 6 121,00 |
| fis-dux08100T | 8 | 110 | 100 | 50 | 500 | 5 812,00 |
| fis-dux08120F | 8 | 130 | 120 | 50 | 250 | 6 519,00 |
| fis-dux08120T | 8 | 130 | 120 | 50 | 250 | 6 409,00 |
| fis-dux10080F | 10 | 90 | 80 | 50 | 250 | 6 624,00 |
| fis-dux10080T | 10 | 90 | 80 | 50 | 250 | 6 090,00 |
| fis-dux10100F | 10 | 110 | 100 | 50 | 250 | 7 536,00 |
| fis-dux10100T | 10 | 110 | 100 | 50 | 250 | 6 647,00 |
| fis-dux10120F | 10 | 130 | 120 | 50 | 250 | 8 072,00 |
| fis-dux10120T | 10 | 130 | 120 | 50 | 250 | 7 442,00 |
| fis-dux10140F | 10 | 150 | 140 | 50 | 250 | 8 787,00 |
| fis-dux10140T | 10 | 150 | 140 | 50 | 250 | 9 097,00 |
| fis-dux10160F | 10 | 170 | 160 | 50 | 250 | 12 051,00 |
| fis-dux10160T | 10 | 170 | 160 | 50 | 250 | 12 567,00 |
| fis-dux10180F | 10 | 190 | 180 | 50 | 50 | 16 441,00 |
| fis-dux10180T | 10 | 190 | 180 | 50 | 50 | 16 740,00 |
| fis-dux10200F | 10 | 210 | 200 | 50 | 50 | 19 508,00 |
| fis-dux10200T | 10 | 210 | 200 | 50 | 50 | 21 022,00 |
| fis-dux10230F | 10 | 240 | 230 | 50 | 50 | 22 481,00 |
| fis-dux10230T | 10 | 240 | 230 | 50 | 50 | 23 870,00 |

Zastosowanie do cegły dziurawki, kratówki i pełnej, pustaków, gazobetonu, betonu lekkiego, betonu, płyt gipsowych oraz innych materiałów budowlanych o niskiej wytrzymałości na ściskanie.

Application for perforated, checked and solid bricks, hollow bricks, aerated concrete, light concrete, concrete, gypsum boards and other building materials with low compressive strength.

Zaślepka do wkrętów

Plastic cap



| INDEX | ZASTOSOWANIE APPLICATION | CENA / PRICE 1000 szt./pcs [PLN] |
|-------|--|--|
| ZWS | Zaślepka do wkrętów - typ konfirmat | 28,00 |
| ZWP2 | Zaślepka do wkrętów - typ PZ2 | 28,00 |
| ZWP3 | Zaślepka do wkrętów - typ Pz3 | 28,00 |
| ZWO | Zaślepka do łączników ościeżnic | 95,00 |
| ZWW | Zaślepka do wkrętów ościeżnicowych - typ WHO | 95,00 |
| KAP | Kapturek maskujący RAL | 277,00 |

Dostępne kolory: BIAŁY, BEŻOWY, BRĄZOWY, CZARNY

Podkładka dystansowa pod zbrojenie (polipropylen)

Reinforcement spacers



| INDEX | GRUBOŚĆ OTULINY BETONU THICKNESS OF THE CONCRETE COVER [mm] | ŚREDNICA PRĘTA DIAMETER OF THE ROD [mm] | ILOŚĆ [szt.] QUANTITY [pcs] | CENA / PRICE 1000 szt./pcs [PLN] | |
|--------|---|---|--------------------------------|--|--------|
| DYS | 15/20/25/30 | 4-12 | 100 | 2000 | 185,00 |
| DYS01 | 15/20/25 | 15-17 | 100 | 2000 | 170,00 |
| DYS011 | 35/40/45/50 | 25 | 100 | 2000 | 423,00 |

Kołpak ochronny na śruby i nakrętki

Bolt protection caps



| INDEX | ROZMIAR SIZE [mm] | CENA / PRICE 1000 szt./pcs [PLN] |
|----------|----------------------|--|
| KOŁSN-05 | SW-8 | 152,00 |
| KOŁSN-06 | SW-10 | 167,00 |
| KOŁSN-08 | SW-13 | 235,00 |
| KOŁSN-10 | SW-17 | 341,00 |
| KOŁSN-12 | SW-19 | 409,00 |
| KOŁSN-14 | SW-22 | 972,00 |
| KOŁSN-16 | SW-24 | 1 200,00 |
| KOŁSN-20 | SW-30 | 1 690,00 |
| KOŁSN-24 | SW-36 | 2 340,00 |

Podkładka nylonowa

Nylon washer

DIN 125



| INDEX | ROZMIAR SIZE [mm] | CENA / PRICE 1000 szt./pcs [PLN] |
|---------|----------------------|--|
| PDKN-05 | M5 | 70,00 |
| PDKN-06 | M6 | 105,00 |
| PDKN-08 | M8 | 125,00 |
| PDKN-10 | M10 | 154,00 |
| PDKN-12 | M12 | 315,00 |
| PDKN-14 | M14 | 630,00 |
| PDKN-16 | M16 | 750,00 |
| PDKN-20 | M20 | 1 150,00 |
| PDKN-24 | M24 | 2 000,00 |

Podkładka szeroka nylonowa

Enlarged nylon washer

DIN 440



| INDEX | ROZMIAR SIZE [mm] | CENA / PRICE 1000 szt./pcs [PLN] |
|----------|----------------------|--|
| PDK2N-05 | M5 | 125,00 |
| PDK2N-06 | M6 | 160,00 |
| PDK2N-08 | M8 | 230,00 |
| PDK2N-10 | M10 | 480,00 |
| PDK2N-12 | M12 | 735,00 |
| PDK2N-16 | M16 | 1 570,00 |

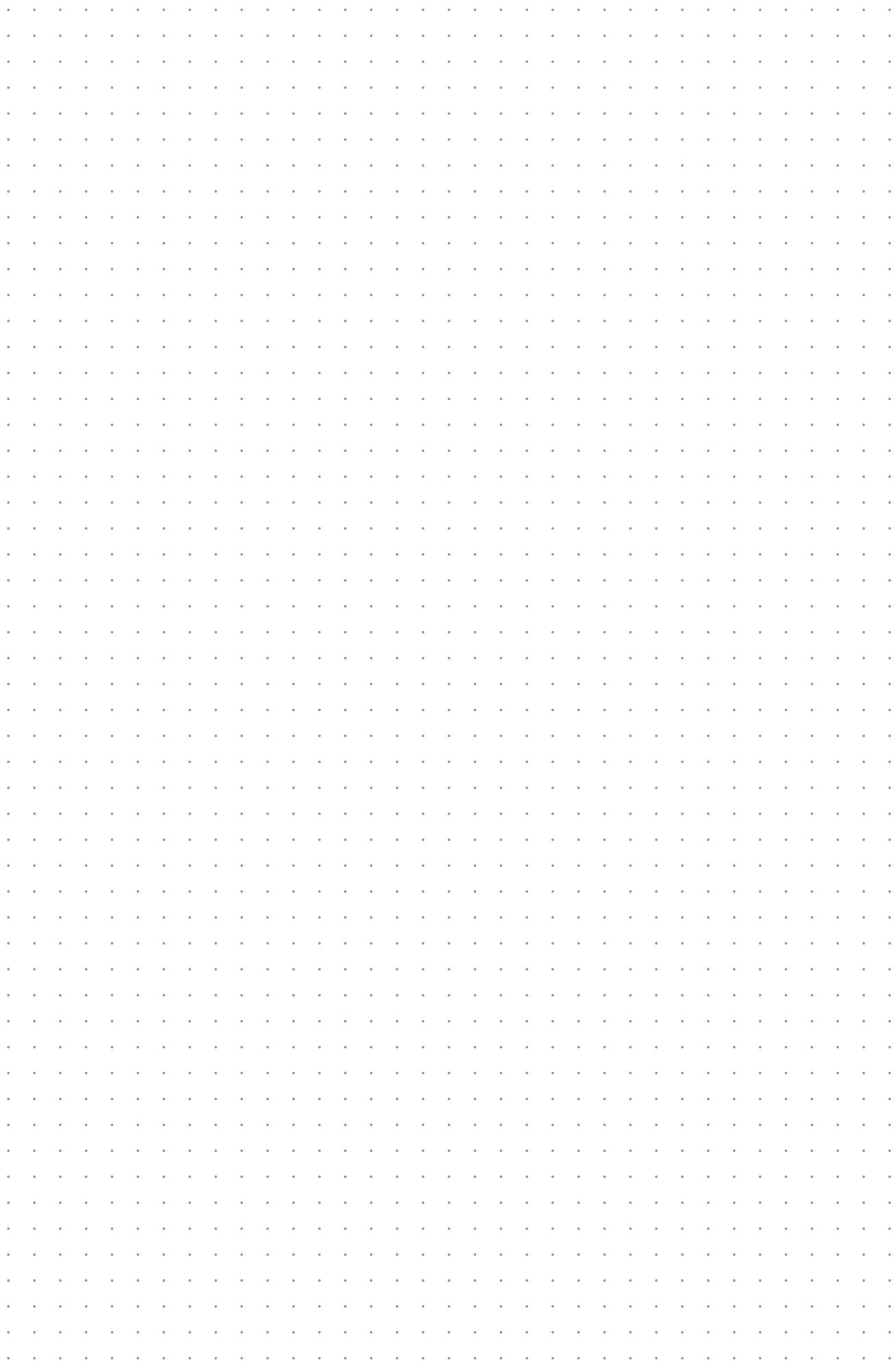

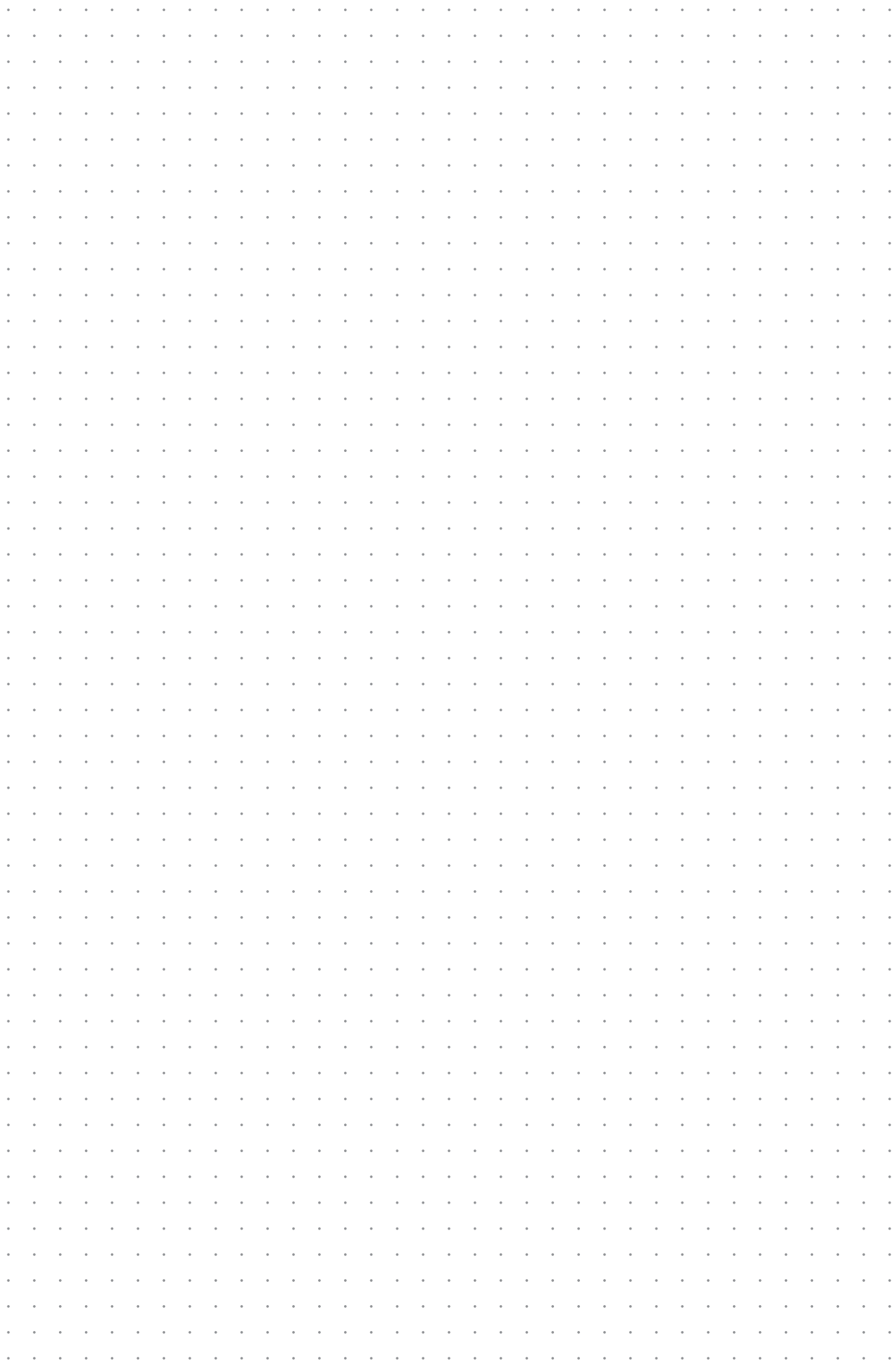

30 LAT
NA RYNKU



MAG-KRAK

FASTENERS & FIXING SYSTEMS

MAG-KRAK sp. z o.o.
ul. Karola Łowińskiego 7
31-752 Kraków, POLAND

EXPORT DEPARTMENT

+48 511 338 030
m.klima@mag-krak.pl

+48 505 187 806
r.chrobak@mag-krak.pl

DYREKTOR HANDLOWY

+48 502 315 359 | s.bryndal@mag-krak.pl



+48 12 643 51 19
+48 12 642 03 75
+48 12 644 08 30
+48 12 644 07 07

biuro@mag-krak.pl
www.mag-krak.pl
www.k2-tools.pl

I. KIEROWNIK REGIONU PŁN.-ZACH.

+48 509 907 073 | m.motylnski@mag-krak.pl

II. KIEROWNIK REGIONU PŁN.-WSCH.

+48 505 526 136 | l.wojtaszowski@mag-krak.pl

III. KIEROWNIK REGIONU PŁD.-WSCH.

+48 502 345 494 | p.marzec@mag-krak.pl

1. BIAŁYSTOK | SUWAŁKI | ŁOMŻA | EŁK

+48 501 032 352 | m.czernik@mag-krak.pl

2. BIELSKO-BIAŁA | NOWY TARG | ZAKOPANE

+48 502 317 335 | p.pawlowski@mag-krak.pl

3. ŁÓDŹ | CZĘSTOCHOWA | RADOMSKO

+48 510 202 810 | t.karas@mag-krak.pl

4. GDYNIA | LĘBORK | KOŚCIERZYNA | STAROGARD GD.

+48 500 045 750 | m.rusiecka@mag-krak.pl

5. KATOWICE | BYTOM | ZABRZE

+48 504 170 634 | j.gorecki@mag-krak.pl

6. OPOLE | GLIWICE | RACIBÓRZ

+48 502 269 679 | t.losa@mag-krak.pl

7. KIELCE | SANDOMIERZ

+48 502 124 440 | m.modzelewski@mag-krak.pl

8. TARNÓW | NOWY SĄCZ | GORLICE

+48 507 060 688 | l.cichocki@mag-krak.pl

9. LUBLIN | ZAMOŚĆ | CHEŁM

+48 509 261 166 | j.sowa@mag-krak.pl

10. POZNAŃ | GNIEZNO | PIŁA | MIĘDZYCHÓD

+48 506 078 969 | d.szepczynski@mag-krak.pl

11. RADOM | PUŁAWY | GRÓJEC | ŚWIĄTNIKI G.

+48 515 278 053 | m.wlodarczyk@mag-krak.pl

12. SUCHA BESKIDZKA | STARY SĄCZ | JĘDRZEJÓW

+48 509 708 102 | g.gajos@mag-krak.pl

13. BARTOSZYCE | KĘTRZYN | ELBLĄG | MRAGOWO

+48 500 579 329 | b.mozarowski@mag-krak.pl

14. ŁÓDŹ | PŁOCK | BEŁCHATÓW

+48 517 918 277 | t.szemiota@mag-krak.pl

15. KONIN | KOŁO | TUREK | SŁUPCA

+48 507 060 686 | a.wrotecki@mag-krak.pl

16. BYDGOSZCZ | GRUDZIĄDZ | ŻNIN

+48 797 518 686 | m.starczewska@mag-krak.pl

17. OLSZTYN | IŁAWA | OSTRÓDA | LUBAWA

+48 502 915 959 | l.sawicki@mag-krak.pl

18. WROCŁAW | LEGNICA | JELENIA GÓRA

+48 515 331 154 | l.borkowski@mag-krak.pl

19. SIEDLCE | BIAŁA PODLASKA

+48 512 097 818 | p.lukomski@mag-krak.pl

20. BIŁGORAJ | TOMASZÓW LUBELSKI

+48 511 337 704 | m.lukasik@mag-krak.pl

21. WARSZAWA

+48 510 257 845 | k.golos@mag-krak.pl

22. KRAKÓW

+48 502 522 350 | r.bielat@mag-krak.pl

23. SZCZECIN | KOSZALIN | ŚWINOUJŚCIE | STARGARD

+48 508 624 081 | r.zmudzinski@mag-krak.pl

24. TORUŃ | WŁOCŁAWEK | BRODNICA

+48 797 400 441 | r.kaftaniak@mag-krak.pl

25. ZIELONA GÓRA | GORZÓW WIELKOPOLSKI

+48 534 402 102 | b.stodolna@mag-krak.pl

26. OPOLE | NYSA | KLUCZBORK

+48 572 702 174 | w.tomczyszyn@mag-krak.pl

27. BUSKO ZDRÓJ | DĄBROWA TARNOWSKA

+48 511 337 330 | d.wasik@mag-krak.pl

28. ŁAŃCUT | PRZEWORSK | JAROSŁAW

+48 517 116 336 | l.kuzniar@mag-krak.pl

29. BRZESKO | TUCHÓW

+48 517 116 354 | l.nowak@mag-krak.pl

30. SZCZAWNICA | PIWNICZA ZDRÓJ

+48 534 206 650 | d.dziura@mag-krak.pl

31. CIECHANÓW | MŁAWA | PRZASNYSZ

+48 572 570 812 | m.bukowski@mag-krak.pl

32. KALISZ | OSTRÓW WIELKOPOLSKI | PLESZEW | KĘPNO

+48 501 212 684 | b.pagowska@mag-krak.pl

33. MYSZKÓW | ZAWIERCIE | DĄBROWA GÓRNICZA

+48 572 702 173 | t.skalski@mag-krak.pl

34. OPOLE | OLESNO | LUBLINIEC

+48 739 131 388 | a.matusz@mag-krak.pl

35. JAWORZNO | MYŚŁOWICE | OLKUSZ

+48 502 705 294 | p.chochorowski@mag-krak.pl

36. RZESZÓW | DEBICA | KROSNO

+48 504 812 459 | b.wojcik@mag-krak.pl

37. TARNOBRZEG | STAŁOWA WOLA | KOLBUSZOWA

+48 505 328 600 | j.pajda@mag-krak.pl

38. PIASECZNO | OTWOCK | GARWOLIN

+48 572 702 175 | r.kowalec@mag-krak.pl

39. SŁUPSK | BYTÓW | CHOJNICE | SZCZECINEK

+48 508 817 710

40. SANOK | LESKO

+48 512 980 199 | m.kowalczyk@mag-krak.pl

41. PROSZOWICE | SŁOMNIKI

+48 696 702 103 | d.marzec@mag-krak.pl

42. LESZNO | RAWICZ | GOSTYŃ

+48 510 685 330 | a.nawrocki@mag-krak.pl

43. ELBLĄG | MALBORK

+48 797 518 645 | a.leszczynski@mag-krak.pl